

OFFICIAL



ARMY DRESS MANUAL

This document is issued for use by Army personnel and is effective forthwith.

A handwritten signature in black ink, appearing to read 'DL Morrison'.

DL Morrison
Lieutenant General
Chief of Army

Department of Defence
CANBERRA ACT 2600

01 February 2013

OFFICIAL

© Commonwealth of Australia 2017

This work is copyright. Apart from any use as permitted under the [Copyright Act 1968](#)¹, no part may be reproduced by any process without prior written permission from the Department of Defence.

All Defence information, whether classified or not, is protected from unauthorised disclosure under the [Crimes Act 1914](#)², Defence information may only be released in accordance with the [Defence Security Manual](#)³ as appropriate.

First Edition 2013

Sponsor

Chief of Army

Developer

Army Ceremonial

Publisher

Defence Publishing, Library and Information Service
Department of Defence
CANBERRA ACT 2600

Effective date

20 December 2019

Review date

18 December 2020

¹ <https://www.legislation.gov.au/Series/C1968A00063>

² <https://www.legislation.gov.au/Series/C1914A00012>

³ <http://intranet.defence.gov.au/dsa/DSM/>

FOREWORD

These orders are issued by the command of the Chief of Army and the Army Dress Manual constitutes a lawful general order. All Australian Army personnel are to ensure that the provisions of the Army Dress Manual are applied and obeyed as orders. Failure to do so is an offence under the [Defence Force Discipline Act 1982](#)⁴.

⁴ <https://www.legislation.gov.au/Series/C2004A02711>

AMENDMENTS

Proposals for amendment of Army Dress Manual are to be forwarded to:

Ceremonial Cell – Army
BLD29-04-003
Department of Defence
CANBERRA ACT 2600

| Amendment number | Chapter(s) | Amendment | Effected date |
|-------------------------|---|--|----------------------|
| AL1 | Chapters 1–6 Chapter 4: Annex 4G, Paragraph 4 Chapter 5: Annex 5N, Paragraphs 4, 7–9, 11, 13–19 Chapter 5: Table 5N–1, Dress Number CT 2 Chapter 5: Annex 5N, pages 4–6 | Editorial change New Deleted Deleted Deleted | 06 Oct 15 |
| AL2 | Chapter 2: Paragraph 2.8 Chapter 2: Paragraph 2.34 Chapter 2: Table 2–2 Chapter 2: Annex 2A, Paragraph 1 Chapter 3: Paragraph 3.20–3.29 Chapter 3: Table 3–2 | New New New New New New | 14 Mar 16 |
| AL3 | Chapter 1 Chapter 2 Chapter 3 Chapter 5 Annex 4L Annex 4P Annex 5O Appendix 5O3 | Editorial change Editorial change Editorial change Editorial change Full review Full review Editorial change Editorial change | 06 Dec 16 |
| AL4 | Chapter 2 Chapter 3 Chapter 5 Annex 5N | Editorial change Editorial change Editorial change Editorial change | 15 Nov 17 |
| AL5 | Chapter 1 Chapter 2 Chapter 3 Chapter 4 Chapter 5 Chapter 6 | Editorial change Editorial change Editorial change Editorial change Review and update Full Review | 20 Dec19 |

CONTENTS

| | |
|--|------------|
| Foreword | iii |
| Amendments | iv |
| Contents | v |
| List of figures | xiv |
| List of tables | xxiv |
| Chapter 1 | 1–1 |
| Introduction | 1–1 |
| Application of the Army Dress Manual | 1–1 |
| Variations to Army Dress Manual | 1–1 |
| Layout of Army Dress Manual | 1–1 |
| Interpretation of the Army Dress Manual | 1–1 |
| Australian Regular Army | 1–2 |
| Active Reserve | 1–2 |
| Standby Reserve | 1–2 |
| Australian Army Cadets | 1–2 |
| Civilian clothing | 1–2 |
| Standards and responsibilities | 1–3 |
| Uniform allowance | 1–4 |
| Special appointments | 1–4 |
| Selected personnel | 1–5 |
| Honorary Colonel/Colonel Commandant and other honorary appointments | 1–6 |
| Dress at receptions | 1–6 |
| Foreign receptions | 1–7 |
| Australian receptions | 1–7 |
| Discretionary judgment | 1–7 |
| Orders of dress worn on particular occasions | 1–7 |
| Wearing of uniforms after separation | 1–7 |
| Chapter 2 | 2–1 |
| Wearing of uniform | 2–1 |
| Alignment of the uniform | 2–1 |
| Ironing of the uniform | 2–1 |
| Specified occasions | 2–1 |
| Members on posting | 2–3 |
| Corps of Staff Cadets | 2–3 |
| Royal Australian Armoured Corps, Royal Australian Regiment, Royal Australian Infantry Corps, Australian Army Aviation, Army Reserve Infantry Regiments, University Regiments, Regional Force Surveillance Units and Special Operations Command | 2–3 |
| Restrictions on wearing the uniform | 2–5 |
| Dress in the office environment | 2–5 |

| | |
|---|-------------|
| Dress in Officers', Sergeants' Messes and Soldiers' Club | 2–5 |
| Dress standards | 2–5 |
| Dress style | 2–6 |
| Service members visiting messes | 2–6 |
| Dress in vehicles | 2–6 |
| Dress for physical training | 2–6 |
| Motorcycles and bicycles | 2–7 |
| Travel on Service aircraft | 2–8 |
| Travel on public or commercial transport within Australia | 2–8 |
| Travel on public or commercial transport outside Australia | 2–8 |
| Military weddings | 2–9 |
| Civilian funerals | 2–9 |
| Forms of civilian attire for social functions | 2–9 |
| Cosmetics | 2–10 |
| Fingernails | 2–11 |
| Hair—Men | 2–11 |
| Beards | 2–12 |
| Moustaches | 2–15 |
| Shaving | 2–15 |
| Hair—Women | 2–16 |
| Hair colouring | 2–16 |
| Radical hairstyles | 2–16 |
| Wigs | 2–22 |
| Jewellery | 2–22 |
| Rings | 2–23 |
| Earrings | 2–23 |
| Watches | 2–23 |
| Body Embellishments | 2–24 |
| Sikh religion | 2–26 |
| Five symbolic requirements | 2–28 |
| Method of wearing Sikh religious accoutrements | 2–29 |
| Covering of arms and legs | 2–29 |
| Annex 2A | 2A–1 |
| Special Operations Command | 2A–1 |
| Chapter 3 | 3–1 |
| Items of dress, embellishments and accoutrements | 3–1 |
| Aiguillette | 3–1 |
| Wearing the aiguillette | 3–5 |
| Attachment of button loop | 3–5 |
| Academic Dress | 3–6 |
| Audio and video equipment | 3–7 |
| Bags and backpacks/Camelbaks | 3–7 |

| | |
|--|-------------|
| Belts | 3-7 |
| Ceremonial belt | 3-7 |
| Sam Browne Belt | 3-8 |
| Waist belt 32 mm | 3-8 |
| Colour belt | 3-11 |
| Belt hooks and keepers | 3-11 |
| Bandoliers | 3-12 |
| Baseball caps | 3-13 |
| Brassards | 3-13 |
| Braces | 3-13 |
| Breeches | 3-13 |
| Boots and footwear | 3-13 |
| Black shoes and black court shoes | 3-14 |
| Patent leather black boots | 3-14 |
| Elastic sided black leather boots | 3-15 |
| Combat boots | 3-16 |
| Black combat boots | 3-16 |
| Safety boots and shoes | 3-16 |
| Laces | 3-16 |
| Briefcases | 3-17 |
| Buttons | 3-17 |
| Canes | 3-18 |
| Cardigans | 3-19 |
| Communication equipment | 3-19 |
| Emu plumes | 3-19 |
| Emu tufts | 3-19 |
| Face Mask | 3-21 |
| Gloves | 3-21 |
| Dark brown or black leather gloves | 3-21 |
| White kid gloves | 3-22 |
| White gauntlet gloves | 3-22 |
| White cotton gloves | 3-22 |
| Handbags and clutch bags | 3-22 |
| Headdress | 3-22 |
| Hat Khaki Fur Felt | 3-23 |
| Chinstrap | 3-24 |
| Puggaree | 3-24 |
| Wearing the Hat Khaki Fur Felt | 3-24 |
| Beret | 3-25 |
| Wearing the beret | 3-28 |
| Corps/Regimental/Unit hat badges | 3-28 |
| Special considerations, risk assessment and sun protection | 3-29 |

| | |
|--|-------------|
| Blue Service cap | 3–29 |
| Field hat | 3–30 |
| Turbans | 3–31 |
| Jibab or Hijab | 3–31 |
| Identification discs | 3–32 |
| Identification arm patches | 3–32 |
| Jackets | 3–34 |
| Australian Multi-cam Camouflage Uniform General Purpose Jacket | 3–34 |
| Garrison jacket | 3–34 |
| Leather motorcycle jacket | 3–36 |
| Utility jacket | 3–36 |
| Service dress jacket | 3–38 |
| Lances | 3–39 |
| Lanyards | 3–39 |
| Legal Dress | 3–44 |
| Mourner’s band or brassards | 3–45 |
| Nameplates | 3–46 |
| Name tags | 3–47 |
| Necktie | 3–47 |
| Necktie khaki polyester | 3–47 |
| Tiepin/clip | 3–48 |
| Orders, decorations and medals | 3–48 |
| Overcoats | 3–52 |
| Overcoat extreme cold weather | 3–52 |
| Overcoat lightweight | 3–53 |
| Pace sticks | 3–53 |
| Pantihose, stockings and footlets for females | 3–55 |
| Parachutist smock | 3–55 |
| Raincoats | 3–55 |
| Sashes | 3–56 |
| Ceremonial waist sash | 3–56 |
| Scarlet shoulder sash | 3–56 |
| Shirts | 3–56 |
| Khaki polyester shirt | 3–56 |
| Australian Multi-cam Camouflage Uniform shirt | 3–57 |
| Shoulder boards | 3–57 |
| Shoulder cords | 3–57 |
| Shoulder patches | 3–58 |
| Field Shoulder Patch | 3–58 |
| Operational shoulder patch | 3–59 |
| Unit shoulder patch | 3–59 |
| Shoulder slides | 3–60 |

| | |
|---|-------------|
| Shoulder titles | 3-60 |
| ‘AUSTRALIA’ shoulder titles | 3-60 |
| Corps shoulder titles | 3-61 |
| Regiment shoulder titles | 3-62 |
| Signs | 3-63 |
| National Distinguishing Sign | 3-63 |
| Skirts | 3-65 |
| Length of skirts | 3-65 |
| Zip Polo Thermal | 3-65 |
| Socks | 3-66 |
| Sunglasses | 3-66 |
| Prescribed spectacles | 3-67 |
| Swords | 3-67 |
| General officers, Senior officers and special appointments | 3-67 |
| Officers and Warrant Officer Class One | 3-67 |
| Ensigns of Flag, Colour Parties, Regimental Sergeant Major and Drum Major | 3-68 |
| Assembly of sword equipment (suspended) | 3-68 |
| Assembly of sword equipment (slung) | 3-72 |
| Sword knots | 3-76 |
| Thongs and sandals | 3-79 |
| Trousers and slacks | 3-79 |
| Umbrellas | 3-79 |
| Underwear | 3-80 |
| Unit colour patch | 3-81 |
| Undershirt and drawers extreme cold weather ensemble | 3-81 |
| Wet and cold weather ensemble | 3-82 |
| Soft shell insulation layer | 3-82 |
| Windproof and cold weather layer | 3-83 |
| Wet weather layer | 3-84 |
| Annex 3A | 3A-1 |
| Chief of Army endorsed range of combat boots | 3A-1 |
| Annex 3B | 3B-1 |
| Chief of Army endorsed range of black combat boots | 3B-1 |
| Annex 3C | 3C-1 |
| Administrative procedures of the Unit Shoulder Patch | 3C-1 |
| Annex 3D | 3D-1 |
| Administrative procedures of the Unit Colour Patch | 3D-1 |
| Annex 3E | 3E-1 |
| Norforce - Indigenous Artwork on Pace Stick | 3E-1 |

| | |
|--|--------------|
| Chapter 4 | 4-1 |
| Badges and emblems | 4-1 |
| Australian Army Rising Sun Badge | 4-1 |
| Positioning the badge on the Ceremonial Hat Khaki Fur Felt | 4-2 |
| Positioning the badge on the Blue Service cap | 4-2 |
| Positioning the badge on the collar | 4-2 |
| Embroidered Australian Army Rising Sun shoulder badge | 4-3 |
| Aircrew badges | 4-4 |
| Army Combat badge | 4-4 |
| Army Individual Readiness Notification badge | 4-5 |
| Corps and regiment badges | 4-5 |
| Infantry Combat badge | 4-5 |
| Military Instructor badge | 4-5 |
| Parachutist badges | 4-6 |
| Rank insignia | 4-6 |
| Recruit Instructor badge | 4-6 |
| Retired member insignia | 4-6 |
| Royal Cypher and Crown insignia | 4-7 |
| Service/Defence Commendation badges | 4-7 |
| Skill at Arms badge | 4-7 |
| Soldiers Medallion badge | 4-8 |
| Trade qualification badges | 4-8 |
| Unit and Group citations and awards | 4-8 |
| Non-ADF and Foreign military awards, badges, unit citations and commendations | 4-9 |
| Members of the ADF | 4-9 |
| Equivalence | 4-10 |
| Applications | 4-10 |
| Transfer between Services | 4-10 |
| PMKeyS | 4-10 |
| Insignia replacement | 4-10 |
| Positioning of Foreign military commendations | 4-11 |
| Annex 4A | 4A-1 |
| Aircrew badges | 4A-1 |
| Annex 4B | 4B-1 |
| Army Combat Badge | 4B-1 |
| Annex 4C | 4C-1 |
| Army Individual Readiness Notification Badge | 4C-1 |
| Annex 4D | 4D-1 |
| Corps/Regiment badge | 4D-1 |
| Appendix 4D1 | 4D1-1 |
| Corps and regimental hat badges of the Australian Army | 4D1-1 |

| | |
|--|--------------|
| Annex 4E | 4E-1 |
| Infantry combat badge | 4E-1 |
| Annex 4F | 4F-1 |
| Military instructor badge | 4F-1 |
| Annex 4G | 4G-1 |
| Parachute badges | 4G-1 |
| Annex 4H | 4H-1 |
| Rank badges and insignia | 4H-1 |
| Appendix 4H1 | 4H-1 |
| Appointment insignia and badges of rank of the Australian Army | 4H-1 |
| Annex 4I | 4I-1 |
| Recruit instructor badge | 4I-1 |
| Annex 4J | 4J-1 |
| Retired Member Insignia | 4J-1 |
| Annex 4K | 4K-1 |
| Royal Cypher and Crown insignia | 4K-1 |
| Annex 4L | 4L-1 |
| Defence Commendations | 4L-1 |
| Annex 4M | 4M-1 |
| Skill at Arms Badge | 4M-1 |
| Annex 4N | 4N-1 |
| Soldiers Medallion Badge | 4N-1 |
| Annex 4O | 4O-1 |
| Trade qualification badge | 4O-1 |
| Appendix 4O1 | 4O1-1 |
| Air dispatcher | 4O1-1 |
| Appendix 4O2 | 4O2-1 |
| Ammunition Technical Officer/Ammunition Technician | 4O2-1 |
| Appendix 4O3 | 4O3-1 |
| Artificer | 4O3-1 |
| Appendix 4O4 | 4O4-1 |
| Conductor (Royal Australian Army Ordnance Corps) Badge | 4O4-1 |
| Appendix 4O5 | 4O5-1 |
| Drummer | 4O5-1 |
| Appendix 4O6 | 4O-1 |
| Explosive Detection Dog | 4O-1 |
| Appendix 4O7 | 4O7-1 |
| Explosive Ordnance Disposal | 4O7-1 |
| Appendix 4O8 | 4O8-1 |
| Emergency Response | 4O8-1 |
| Appendix 4O9 | 4O-1 |
| Ground Crewman Aircraft Support | 4O-1 |

| | |
|--|---------------|
| Appendix 4O10 | 4O10–1 |
| Musician | 4O10–1 |
| Appendix 4O11 | 4O11–1 |
| Operator Petroleum | 4O11–1 |
| Appendix 4O12 | 4O12–1 |
| Parachute Rigger | 4O12–1 |
| Appendix 4O13 | 4O13–1 |
| Piper | 4O13–1 |
| Appendix 4O14 | 4O14–1 |
| Physical training instructor | 4O14–1 |
| Annex 4P | 4P–1 |
| Unit and Group Citations | 4P–1 |
| Chapter 5 | 5–1 |
| Orders of dress | 5–1 |
| General | 5–1 |
| Women Wearing the Australian Army Uniform | 5–1 |
| Orders of dress | 5–1 |
| Dress Order No 1A ‘Ceremonial Parade Service Dress’ | 5–3 |
| Dress Order No 1B ‘Ceremonial Service Dress’ | 5–8 |
| Dress Order No 1C ‘General Duty Service Dress’ | 5–13 |
| Dress Order No 2A ‘Ceremonial Parade Dress’ | 5–17 |
| Dress Order No 2B ‘Ceremonial Parade Dress Cold Weather’ | 5–21 |
| Dress Order No 2C ‘Ceremonial Dress’ | 5–24 |
| Dress Order No 2D ‘Ceremonial Dress Cold Weather’ | 5–28 |
| Dress Order No 2E ‘General Duty Dress (polyesters)’ | 5–31 |
| Dress Order No 2F ‘General Duty Dress Cold Weather’ | 5–38 |
| Dress Order No 3A ‘Ceremonial Safari Suit’ | 5–46 |
| Dress Order No 4A ‘General Duty Dress (Australian Multi-cam Camouflage Uniform)’ | 5–48 |
| Dress Order No 4B ‘Field Dress (Australian Multi-cam Camouflage Uniform)’ | 5–51 |
| Dress Order No 4C ‘Combat Dress (Australian Multi-cam Camouflage Uniform)’ | 5–54 |
| Dress Order No 5A ‘Armoured Fighting Vehicle Crewman, Australian Multi-cam Camouflage Uniform’ | 5–58 |
| Dress Order No 5B ‘Combat dress Flame Retardant Tank Crewman, Australian Multi-cam Camouflage Uniform’ | 5–60 |
| Dress Order No 6A ‘Mess Dress’ | 5–62 |
| Dress Order No 6B ‘Mess Dress White Jacket’ | 5–66 |
| Dress Order No 6C ‘Senior Ranks Mess Dress’ | 5–71 |
| Dress Order No 6D ‘Mess Dress Army’ | 5–75 |
| Dress Order No 7 ‘Working/Protective Dress’ | 5–79 |
| Dress Order No 8 ‘Maternity Dress’ | 5–84 |

| | |
|---|--------------|
| Dress Order No 9 ‘Aircrew Flame Retardant Flying Dress’ | 5–85 |
| Annex 5A | 5A–1 |
| Orders of Dress worn on particular occasions | 5A–1 |
| Annex 5B | 5B–1 |
| Special order of dress for special appointments/selected personnel | 5B–1 |
| Annex 5C | 5C–1 |
| Senior officer dress | 5C–1 |
| Annex 5D | 5D–1 |
| Band ceremonial dress | 5D–1 |
| Annex 5E | 5E–1 |
| Scottish dress | 5E–1 |
| Annex 5F | 5F–1 |
| Chaplain dress | 5F–1 |
| Annex 5G | 5G–1 |
| Army emergency response dress | 5G–1 |
| Annex 5H | 5H–1 |
| Military equestrian dress | 5H–1 |
| Annex 5I | 5I–1 |
| Australian Defence Force Academy Dress | 5I–1 |
| Annex 5J | 5J–1 |
| Royal Military College—Duntroon Dress | 5J–1 |
| Annex 5K | 5K–1 |
| Physical Training Instructor Dress | 5K–1 |
| Annex 5L | 5L–1 |
| Medical, Dental and Nursing Working Dress | 5L–1 |
| Annex 5M | 5M–1 |
| Military Police Dress | 5M–1 |
| Annex 5N | 5N–1 |
| Catering trade dress | 5N–1 |
| Annex 5O | 5O–1 |
| Mess Dress | 5O–1 |
| Appendix 5O1 | 5O1–1 |
| Positioning of embellishments for Mess Dress Order No 6C and Mess Dress Order No 6D | 5O1–1 |
| Appendix 5O2 | 5O2–1 |
| Rising Sun, Trade, Parachute, Aircrew, Parachute Instructor and Military Skills Badges for Mess Dress Order No 6C and Dress Order No 6D | 5O2–1 |
| Appendix 5O3 | 5O3–1 |
| Mess Dress Order No 6A and Mess Dress Order No 6B | 5O3–1 |
| Annex 5P | 5P–1 |
| Tri-Service equivalencies Orders of Dress | 5P–1 |

| | |
|--|-------------|
| Chapter 6 | 6-1 |
| Orders, Decorations and medals | 6-1 |
| Introduction | 6-1 |
| History | 6-1 |
| General | 6-2 |
| Definitions | 6-2 |
| Promotion within an Order | 6-4 |
| Bars to Awards | 6-5 |
| Awards for which a Medal is not Awarded | 6-5 |
| Unofficial Awards | 6-5 |
| Foreign Awards | 6-6 |
| Award Specifications, Regulations and Assembly Instructions | 6-6 |
| Order of Wearing | 6-6 |
| Annexes: | 6-6 |
| Annex 6A | 6A-1 |
| Wearing of Orders, Decorations and Medals | 6A-1 |
| Annex 6B | 6B-1 |
| Annex 6C | 6C-1 |
| Annex 6D | 6D-1 |
| Annex 6E | 6E-1 |

LIST OF FIGURES

| | |
|---|------|
| Figure 2-1: Fingernail varnish-permissible shades | 2-11 |
| Figure 2-2: a French Roll | 2-18 |
| Figure 2-3: a Bun | 2-18 |
| Figure 2-4: Single braid with bun | 2-19 |
| Figure 2-5: Ponytail with plait | 2-19 |
| Figure 2-6: A Single Braid | 2-20 |
| Figure 2-7: Ponytail | 2-20 |
| Figure 2-8: Bun | 2-21 |
| Figure 2-9: A ponytail with a plait field/PT | 2-21 |
| Figure 2-10: A ponytail PT | 2-22 |
| Figure 2-11: Soldier Killed in Action memorial bracelet | 2-23 |
| Figure 2-12: Positioning of the hat badge on a turban | 2-28 |
| Figure 3-1: Assembly of the aiguillette (left or right) | 3-5 |
| Figure 3-2: Wearing the aiguillette | 3-6 |
| Figure 3-3: Wearing the ceremonial belt | 3-9 |
| Figure 3-4: Wearing the Sam Browne Belt | 3-10 |
| Figure 3-5: Wearing the waist belt 32 mm | 3-10 |
| Figure 3-6: Female buckle | 3-11 |
| Figure 3-7: Male buckle | 3-11 |
| Figure 3-8: Keeper | 3-12 |
| Figure 3-9: Hooks (flat face) | 3-12 |
| Figure 3-10: Hooks (rolled brass) | 3-12 |

| | |
|---|------|
| Figure 3–11: Acceptable Court Shoe | 3–14 |
| Figure 3–12: Line 30 button and line 30 button (screw-in) | 3–17 |
| Figure 3–13: Cane (swagger stick) Adjutant | 3–19 |
| Figure 3–14: Specifications for emu plumes | 3–20 |
| Figure 3–15: Specifications for emu tufts | 3–21 |
| Figure 3–16: Wearing the Ceremonial Hat Khaki Fur Felt—brim up | 3–25 |
| Figure 3–17: Wearing the General Duty Hat Khaki Fur Felt—brim down | 3–25 |
| Figure 3–18: Wearing the beret | 3–28 |
| Figure 3–19: Wearing the Blue Service Cap | 3–30 |
| Figure 3-20: AMCU Field Cap | 3–31 |
| Figure 3-21: Black Field Cap | 3–31 |
| Figure 3–22: Identification disc (hexagonal type) with necklace identification tag | 3–32 |
| Figure 3–23: Designs of identification arm patches | 3–33 |
| Figure 3–24: Garrison jacket | 3–35 |
| Figure 3–25: Utility jacket – left side | 3–37 |
| Figure 3–26: Utility jacket – right side | 3–38 |
| Figure 3–27: Method of knotting and wearing the lanyard (right shoulder) | 3–40 |
| Figure 3–28: Method of knotting and wearing the lanyard (left shoulder) | 3–41 |
| Figure 3–29: Nameplate specifications | 3–46 |
| Figure 3–30: Wearing the nameplate | 3–46 |
| Figure 3–31: Name tag specifications | 3–47 |
| Figure 3–32: Wearing the name tag | 3–47 |
| Figure 3–33: Tying the Windsor knot (steps 1 and 2) | 3–49 |
| Figure 3–34: Tying the Windsor knot (steps 3 and 4) | 3–50 |
| Figure 3–35: Tying the Windsor knot (steps 5 and 6) | 3–51 |
| Figure 3–36: Tying the Windsor knot (the final knot) | 3–52 |
| Figure 3–37: Overcoat extreme cold weather | 3–53 |
| Figure 3–38: Positioning rank insignia on shoulder cords on the left and right shoulder – Lieutenant to Major General | 3–58 |
| Figure 3–39: Gold and black 'AUSTRALIA' shoulder titles | 3–61 |
| Figure 3–40: An example of Corps and Regiment shoulder titles | 3–62 |
| Figure 3–41: Positioning 'AUSTRALIA' shoulder titles | 3–63 |
| Figure 3–42: High visibility sign distinguishing-Australian National Flag | 3–64 |
| Figure 3–43: Low visibility sign distinguishing-Australian National Flag | 3–64 |
| Figure 3–44: Zip Polo Thermal | 3–66 |
| Figure 3–45: Assembly of sword equipment (suspended) | 3–69 |
| Figure 3–46: Wearing sword equipment (suspended) | 3–70 |
| Figure 3–47: Sword knot—Mameluke sword | 3–71 |
| Figure 3–48: Sword knot—Mameluke sword | 3–72 |
| Figure 3–49: Positioning of left hand-suspended equipment | 3–72 |
| Figure 3–50: Carriage of sword-suspended equipment | 3–72 |
| Figure 3–51: Components of sword equipment (slung) | 3–74 |
| Figure 3–52: Assembling of sword equipment (slung) | 3–75 |
| Figure 3–53: Wearing sword equipment (slung) | 3–75 |
| Figure 3–54: Sword knots (step 1) | 3–76 |
| Figure 3–55: Sword knots (step 2) | 3–77 |
| Figure 3–56: Sword knots (step 3) | 3–77 |
| Figure 3–57: Sword knots (step 4) | 3–78 |
| Figure 3–58: Army logo green T-shirt – front | 3–80 |
| Figure 3–59: Army logo green T-shirt – back | 3–81 |
| Figure 3–60: Undershirt and drawers extreme cold weather ensemble | 3–82 |

| | |
|--|------|
| Figure 3–61: Soft shell insulation ensemble | 3–83 |
| Figure 3–62: Windproof and cold weather layer | 3–83 |
| TBA | 3–83 |
| Figure 3–65: Wet weather layer | 3–84 |
| Figure 3A–1: Salomon XA Forces Mid | 3A–2 |
| Figure 3A–2: ALTAMA 4158 3LC Hot Weather | 3A–2 |
| Figure 3A–3: ALTAMA 4156 | 3A–2 |
| Figure 3A–4: BELLEVILLE M590 Hot Weather | 3A–3 |
| Figure 3A–5: BELLEVILLE M591 Hot Weather | 3A–3 |
| Figure 3A–6: BATES 30501 Durashock Desert | 3A–3 |
| Figure 3A–7: CROSSFIRE Peacekeeper Plus | 3A–4 |
| Figure 3A–8: DANNER Arcadia Desert | 3A–4 |
| Figure 3A–9: MEINDL Desert Fox Safari | 3A–4 |
| Figure 3A–10: LOWA Urban Desert | 3A–5 |
| Figure 3A–11: GARMONT T8 Multi Terrain | 3A–5 |
| Figure 3B–1: Oakley S.I. Assault Boot TM | 3B–2 |
| Figure 3B–2: TERA Heat Resistant Black Boot | 3B–3 |
| Figure 3C–1: Positioning the Unit Shoulder Patch on the Disruptive Pattern Combat Uniform/Australian Multi-cam Camouflage Uniform shirt | 3C–4 |
| Figure 3D–1: Positioning the Unit Colour Patch on the Hat Khaki Fur Felt | 3D–2 |
| Figure 4–1: Australian Army Rising Sun Badge | 4–1 |
| Figure 4–2: Australian Army Rising Sun Badge positioning on the Ceremonial Hat Khaki Fur Felt | 4–2 |
| Figure 4–3: Positioning the embroidered/bullion Australian Army Rising Sun Shoulder Badge | 4–4 |
| Figure 4A–1: Aircrew badges | 4A–2 |
| Figure 4A–2: Positioning aircrew badges | 4A–3 |
| Figure 4B–1: Army Combat Badge | 4B–1 |
| Figure 4B–2: Army Combat Badge with ribbons | 4B–2 |
| Figure 4B–3: Army Combat Badge with Aircrew Badge | 4B–2 |
| Figure 4C–1: Army Individual Readiness Notification Badge | 4C–1 |
| Figure 4C–2: Positioning the Army Individual Readiness Notification Badge | 4C–3 |
| Figure 4D–1: Royal Australian Artillery Officers and WO1 collar badge | 4D–2 |
| Figure 4D–2: Royal Australian Artillery WO2 and below rank collar badge | 4D–2 |
| Figure 4D–3: Royal Australian Engineers Officers and WO1 collar badge | 4D–3 |
| Figure 4D–4: Royal Australian Engineer WO2 and below rank collar badge | 4D–3 |
| Figure 4D–5: Regimental Sergeant Major – Army, Tier C Regimental Sergeant Major and Australian Federal Guard collar badge | 4D–4 |
| Figure 4D–6: Positioning the badges on headdress | 4D–5 |
| Figure 4D–7: Positioning the collar badge on Service Dress | 4D–6 |
| Figure 4D–8: Positioning the collar badge on Patrol Blue orders of dress | 4D–7 |
| Figure 4D–9: Positioning the Royal Australian Artillery and Royal Australian Engineer badges on Patrol Blue orders of dress | 4D–7 |
| Figure 4E–1: Infantry Combat Badge | 4E–1 |
| Figure 4E–2: Infantry Combat Badge with ribbons | 4E–2 |
| Figure 4E–3: Infantry Combat Badge with Parachute Jump Instructor Badge | 4E–3 |
| Figure 4F–1: Military Instructor Badge | 4F–1 |
| Figure 4F–2: Positioning the Military Instructor Badge | 4F–2 |
| Figure 4F–3: Positioning the Military Instructor Badge worn on Training Establishment Identification Arm Patch on General Duty (Australian Multi-cam Camouflage Uniform) | 4F–2 |

| | |
|--|-------|
| Figure 4G–1: Parachute and Parachute Instructor Badges | 4G–2 |
| Figure 4G–2: Positioning the Parachute Badge | 4G–5 |
| Figure 4H–1: Positioning the Officer Badges of Rank | 4H–3 |
| Figure 4H–2: Service Dress and Utility Jacket for WO2 and WO1 rank | 4H–5 |
| Figure 4H–3: Shirts for WO2 and WO1 rank | 4H–5 |
| Figure 4H–4: Service Dress and Utility Jacket for PTE (E) to SGT rank | 4H–7 |
| Figure 4H–5: Shirts for PTE (E) to SGT rank | 4H–7 |
| Figure 4I–1: Recruit Instructor Badge | 4I–1 |
| Figure 4I–2: Positioning the Recruit Instructor Badge | 4I–2 |
| Figure 4J–1: Retired Member Insignia (gold and silver/chrome) | 4J–1 |
| Figure 4J–2: Positioning the Retired Member Insignia | 4J–3 |
| Figure 4K–1: Royal Cypher and Crown Insignia (small) | 4K–1 |
| Figure 4K–2: Royal Cypher and Crown Insignia (large) | 4K–1 |
| Figure 4K–3: Positioning the Royal Cypher and Crown Insignia | 4K–2 |
| Figure 4K–4: Positioning the Royal Cypher and Crown Insignia on shoulder cords | 4K–2 |
| Figure 4L–1: Secretary and Chief of the Defence Force Commendation | 4L–1 |
| Figure 4L–2: Chief of the Defence Force Commendation | 4L–1 |
| Figure 4L–3: Secretary Commendation | 4L–1 |
| Figure 4L–4: Australian Defence Force (Level 3 – Gold Level) Commendation | 4L–2 |
| Figure 4L–5: Australian Army (Level 3 – Gold Level) Commendation | 4L–2 |
| Figure 4L–6: Royal Australian Navy (Level 3 – Gold Level) Commendation | 4L–2 |
| Figure 4L–7: Royal Australian Air Force (Level 3 – Gold Level) Commendation | 4L–2 |
| Figure 4L–8: Defence Support Services (Level 3 – Gold Level) Commendation | 4L–3 |
| Figure 4L–9: Australian Defence Force (Level 2 – Silver Level) Commendation | 4L–3 |
| Figure 4L–10: Australian Army (Level 2 – Silver Level) Commendation | 4L–3 |
| Figure 4L–11: Royal Australian Navy (Level 2 – Silver Level) Commendation | 4L–3 |
| Figure 4L–12: Royal Australian Air Force (Level 2 – Silver Level) Commendation | 4L–4 |
| Figure 4L–13: Defence Support Services (Level 2 – Silver Level) Commendation | 4L–4 |
| Figure 4L–14: Australian Defence Force (Level 1 – Bronze Level) Commendation | 4L–4 |
| Figure 4L–15: Australian Army (Level 1 – Bronze Level) Commendation | 4L–4 |
| Figure 4L–16: Royal Australian Navy (Level 1 – Bronze Level) Commendation | 4L–5 |
| Figure 4L–17: Royal Australian Air Force (Level 1 – Bronze Level) Commendation | 4L–5 |
| Figure 4L–18: Defence Support Services (Level 1 – Bronze Level) Commendation | 4L–5 |
| Figure 4L–19: Wearing Defence Commendation Badges | 4L–6 |
| Figure 4L–20: Wearing Defence Commendation Badges | 4L–7 |
| Figure 4M–1: Skill at Arms Badge | 4M–1 |
| Figure 4M–2: Positioning the Skill at Arms and Sniper Badge | 4M–3 |
| Figure 4M–3: Sniper Badge | 4M–3 |
| Figure 4M–4: Army Top 20 Badge | 4M–4 |
| Figure 4N–1: Soldiers Medallion Badge | 4N–1 |
| Figure 4O–1: Positioning the Trade Badges | 4O–3 |
| Figure 4O1–1: Air Dispatcher Badge | 4O1–1 |
| Figure 4O2–1: Ammunition Technical Officer/Ammunition Technician Badge | 4O2–1 |
| Figure 4O3–1: Artificer Badge | 4O3–1 |
| Figure 4O4–1: Conductor (Royal Australian Army Ordnance Corps) Badge | 4O4–1 |

| | |
|--|--------|
| Figure 4O5–1: Drummer Badge | 4O5–1 |
| Figure 4O6–1: Explosive Detection Dog Badge | 4O–1 |
| Figure 4O7–1: Explosive Ordnance Disposal Badge | 4O7–1 |
| Figure 4O8–1: Emergency Response Badge | 4O8–1 |
| Figure 4O9–1: Ground Crewman Aircraft Support (GCAS) Badge | 4O–1 |
| Figure 4O10–1: Musician Badge | 4O10–1 |
| Figure 4O11–1: Operator Petroleum Badge | 4O11–1 |
| Figure 4O11–2: Operator Petroleum Badge khaki background | 4O11–1 |
| Figure 4O12–1: Parachute Rigger Badge | 4O12–1 |
| Figure 4O13–1: Piper Badge | 4O13–1 |
| Figure 4O14–1: Physical Training Instructor Badge | 4O14–1 |
| Figure 4P–1: Emblems of Awards in Order of Precedence | 4P–2 |
| Figure 4P–2: US Navy/Marine Corps Unit Awards | 4P–3 |
| Figure 4P–3: US Army Unit Awards | 4P–3 |
| Figure 4P–4: US Air Force and Space Force Unit Awards | 4P–4 |
| Figure 4P–5: NZDF Individual Commendations | 4P–4 |
| Figure 4P–6: CAF Individual Commendations | 4P–5 |
| Figure 4P–7: Positioning the Unit/Group Citation Emblem(s) | 4P–5 |
| Figure 4P–8: Unit/Group Citation Emblems with Restricted wear Award | 4P–7 |
| Figure 5–1: Dress Order No 1A ‘Ceremonial Parade Service Dress’ (Other Ranks) | 5–5 |
| Figure 5–2: Dress Order No 1A ‘Ceremonial Parade Service Dress’ (Non-Commissioned Officer) | 5–6 |
| Figure 5–3: Dress Order No 1A ‘Ceremonial Parade Service Dress’ (Officer) | 5–7 |
| Figure 5–4: Dress Order No 1B ‘Ceremonial Service Dress’ (Other Ranks) | 5–10 |
| Figure 5–5: Dress Order No 1B ‘Ceremonial Service Dress’ (Non-Commissioned Officer) | 5–11 |
| Figure 5–6: Dress Order No 1B ‘Ceremonial Service Dress’ (Officer) | 5–12 |
| Figure 5–7: Dress Order No 1C ‘General Duty Service Dress’ (Other Ranks) | 5–14 |
| Figure 5–8: Dress Order No 1C ‘General Duty Service Dress’ (Non-Commissioned Officer) | 5–15 |
| Figure 5–9: Dress Order No 1C ‘General Duty Service Dress’ (Officer) | 5–16 |
| Figure 5–10: Dress Order No 2A ‘Ceremonial Parade Dress’ (OR) | 5–18 |
| Figure 5–11: Dress Order No 2A ‘Ceremonial Parade Dress’ (Non-Commissioned Officer) | 5–19 |
| Figure 5–12: Dress Order No 2A ‘Ceremonial Parade Dress’ (Officer) | 5–20 |
| Figure 5–13: Dress Order No 2B ‘Ceremonial Parade Dress Cold Weather’ (Non-Commissioned Officer) | 5–22 |
| Figure 5–14: Dress Order No 2B ‘Ceremonial Parade Dress Cold Weather’ (Officer) | 5–23 |
| Figure 5–15: Dress Order No 2C ‘Ceremonial Dress’ (Other Ranks) | 5–25 |
| Figure 5–16: Dress Order No 2C ‘Ceremonial Dress’ (Non-Commissioned Officer) | 5–26 |
| Figure 5–17: Dress Order No 2C ‘Ceremonial Dress’ (Officer) | 5–27 |
| Figure 5–18: Dress Order No 2D ‘Ceremonial Dress Cold Weather’ (Non-Commissioned Officer) | 5–29 |
| Figure 5–19: Dress Order No 2D ‘Ceremonial Dress Cold Weather’ (Officer) | 5–30 |
| Figure 5–20: Dress Order No 2E ‘General Duty Dress (polyesters)’ (Other Ranks) | 5–32 |
| Figure 5–21: Dress Order No 2E ‘General Duty Dress (polyesters)’ (Non-Commissioned Officer) | 5–33 |

| | |
|--|------|
| Figure 5–22: Dress Order No 2E ‘General Duty Dress (polyesters)’ (Non-Commissioned Officer) | 5–34 |
| Figure 5–23: Dress Order No 2E ‘General Duty Dress (polyesters)’ (Officer) | 5–35 |
| Figure 5–24: Dress Order No 2E ‘General Duty Dress (polyesters)’ (Officer) | 5–36 |
| Figure 5–25: Dress Order No 2E ‘General Duty Dress (polyesters)’ | 5–37 |
| Figure 5–26: Dress Order No 2F ‘General Duty Dress Cold Weather’ (Other Ranks) | 5–39 |
| Figure 5–27: Dress Order No 2F ‘General Duty Dress Cold Weather’ (Non-Commissioned Officer) | 5–40 |
| Figure 5–28: Dress Order No 2F ‘General Duty Dress Cold Weather’ (Non-Commissioned Officer) | 5–41 |
| Figure 5–29: Dress Order No 2F ‘General Duty Dress Cold Weather’ (Officer) | 5–42 |
| Figure 5–30: Dress Order No 2F ‘General Duty Dress Cold Weather’ (Officer) | 5–43 |
| Figure 5–31: Dress Order No 2G ‘General Duty Office Dress’ | 5–45 |
| Figure 5–32: Dress Order No 3A ‘Ceremonial Safari Suit Ceremonial Order with HKFF Brim Up’ | 5–47 |
| Figure 5–33: Dress Order No 3A ‘Ceremonial Safari Suit in General Duty Order with HKFF Brim Down’ | 5–48 |
| Figure 5–34: Dress Order No 4A ‘General Duty Dress (Australian Multi-cam Camouflage Uniform)’ | 5–50 |
| Figure 5–35: Dress Order No 4A ‘General Duty Dress (Australian Multi-cam Camouflage Uniform)’ | 5–51 |
| Figure 5–36: Dress Order No 4B ‘Field Dress (Australian Multi-cam Camouflage Uniform)’ | 5–53 |
| Figure 5–37: Dress Order No 4B ‘Field Dress (Australian Multi-cam Camouflage Uniform)’ | 5–54 |
| Figure 5–38: Dress Order No 4C ‘Combat Dress (Australian Multi-cam Camouflage Uniform)’ | 5–56 |
| Figure 5–39: Dress Order No 4C ‘Combat Dress (Australian Multi-cam Camouflage Uniform)’ | 5–57 |
| Figure 5–40: Dress Order No 5A ‘Combat Dress AFV Crewman (Australian Multi-cam Camouflage Uniform)’ | 5–59 |
| Figure 5–41: Dress Order No 5B ‘Armoured Fighting Vehicle Crewman, Flame Retardant Combat Dress (Australian Multi-cam Camouflage Uniform)’ | 5–61 |
| Figure 5–42: Dress Order No 6A ‘Mess Dress’ | 5–64 |
| Figure 5–43: Dress Order No 6A ‘Mess Dress’ | 5–65 |
| Figure 5–44: Dress Order No 6B ‘Mess Dress White Jacket’ (Senior Non-Commissioned Officer) | 5–68 |
| Figure 5–45: Dress Order No 6B ‘Mess Dress White Jacket’ (Officer) | 5–69 |
| Figure 5–46: Dress Order No 6B ‘Mess Dress White Jacket’ (Officer) | 5–70 |
| Figure 5–47: Dress Order No 6C ‘Senior Ranks Mess Dress’ (Officer) | 5–73 |
| Figure 5–48: Dress Order No 6C ‘Senior Ranks Mess Dress’ (Regimental Sergeant Major – Army and Tier C Regimental Sergeant Major) | 5–74 |
| Figure 5–49: Dress Order No 6D ‘Mess Dress Army’ (Senior Non-Commissioned Officer) | 5–77 |
| Figure 5–50: Dress Order No 6D ‘Mess Dress Army’ (Officer) | 5–78 |
| Figure 5–51: Dress Order No 7 ‘Working/Protective Dress (Shorts)’ | 5–80 |
| Figure 5–14: Dress Order No 7 ‘Working/Protective Dress (Trousers)’ | 5–81 |
| Figure 5–53: Dress Order No 7 ‘Working/Protective Dress (Trousers with Long Sleeve Shirt)’ | 5–82 |

| | |
|--|-------|
| Figure 5–54: Dress Order No 7 ‘Working/Protective Dress (Trousers with Jacket Khaki Drill)’ | 5–83 |
| Figure 5–55: Dress Order No 8 ‘Maternity Dress Shirt without breast pockets’ | 5–85 |
| Figure 5–56: Dress Order No 8 ‘Maternity Dress Shirt with breast pockets’ | 5–85 |
| Figure 5–57: Dress Order No 4A ‘Maternity Dress (Australian Multi-cam Camouflage Uniform)’ | 5–85 |
| Figure 5–58: Dress Order No 9 ‘Aircrew Flame Retardant Flying Dress with Field Hat’ | 5–87 |
| Figure 5B–1: Dress Order No SA 1 ‘Patrol Blue White Jacket’ | 5B–5 |
| Figure 5B–2: Dress Order No SA 2 ‘Patrol Blue Jacket’ | 5B–8 |
| Figure 5C–1: Hat and Cap Badge – General Officer | 5C–3 |
| Figure 5C–2: Hat and Cap Badge – General Staff Officer and Senior Officer | 5C–3 |
| Figure 5C–3: Positioning the General Officer Badge on headdress | 5C–5 |
| Figure 5C–4: Positioning the Senior Officer Badge on headdress | 5C–6 |
| Figure 5C–5: Gorget patches (large left and right) for Senior officers | 5C–7 |
| Figure 5C–6: Gorget patches (small right and left) for Senior officers, facing the wearer | 5C–7 |
| Figure 5C–7: Gorget patches (large right and left) for General officers, facing the wearer | 5C–8 |
| Figure 5C–8: Gorget patches (small right and left) for General officers, facing the wearer | 5C–8 |
| Figure 5C–9: Positioning the gorget patches on garments | 5C–10 |
| Figure 5C–10: Wearing crossed sword and baton insignia, facing the wearer | 5C–11 |
| Figure 5C–11: Dress Order No SO1 ‘Patrol Blue White Jacket Senior Officer’ | 5C–14 |
| Figure 5C–12: Dress Order No SO2 ‘Patrol Blue Jacket Senior Officer’ | 5C–16 |
| Figure 5C–13: Dress Order No SO3 ‘Ceremonial Service Dress General Officer’ | 5C–18 |
| Figure 5C–14: Dress Order No SO4 ‘Staff Corps Senior Ranks Mess Dress’ | 5C–21 |
| Figure 5D–1: Positioning the medals on the Drum Major Sash | 5D–4 |
| Figure 5D–2: Dress Order No BC1—No 1 Australian Army Band Corps Ceremonial Dress (Royal Military College – Duntroon) | 5D–3 |
| Figure 5D–3: Dress Order No BC1—No 1 Australian Army Band Corps Ceremonial Dress (Royal Military College – Duntroon), with Dress Cord Australian Army Band Corps | 5D–4 |
| Figure 5E–1: Dress Order No SD1A ‘Scottish Ceremonial Parade Service Dress’ (Royal Stewart tartan Tartan shown) | 5E–9 |
| Figure 5E–2: Dress Order No SD1B ‘Scottish Ceremonial Service Dress’ (Australian Tartan shown) | 5E–12 |
| Figure 5E–3: Dress Order No SD1C ‘Scottish General Duty Service Dress’ (Australian Tartan shown) | 5E–14 |
| Figure 5E–4: Dress Order No SD2A ‘Scottish Ceremonial Parade Dress’ (Australian Tartan shown) | 5E–17 |
| Figure 5E–5: Dress Order No SD2B ‘Scottish Ceremonial Dress’ (Royal Stewart Tartan shown) | 5E–20 |
| Figure 5E–6: Dress Order No SD2C ‘Scottish General Duty Dress’ (Australian Tartan shown) | 5E–22 |
| Figure 5E–7: Dress Order No SD3 ‘Scottish Mess Dress’ (Black Jacket) (Australian Tartan shown) | 5E–25 |
| Figure 5E–8: Dress Order No SD3 ‘Scottish Mess Dress’ (White Jacket) (Australian Tartan shown) | 5E–26 |

| | |
|---|-------|
| Figure 5E–9: Dress Order No 4A ‘General Duty Dress (Disruptive Pattern Camouflage Uniform) Pipes and Drums’ (8/9 Royal Australian Regiment Pipes and Drums shown) | 5E–28 |
| Figure 5E–9: Dress Order No SD5W ‘Scottish Ceremonial Dress White Jacket’ (8/9 Royal Australian Regiment Piper shown) | 5E–30 |
| Figure 5E–10: Dress Order No SD5G ‘Scottish Ceremonial Dress Green Jacket’ (8/9 Royal Australian Regiment Drum Major shown) | 5E–33 |
| Figure 5F–1: Metal Christian cross and Star of David–Jewish badges | 5F–1 |
| Figure 5F–2: Embroidered black Christian cross | 5F–2 |
| Figure 5F–3: Positioning the Chaplain insignia on open neck shirt and jackets | 5F–2 |
| Figure 5G–1: Army Emergency Response Badge | 5G–1 |
| Figure 5G–2: Dress Order No ER1 ‘Emergency Response Working Dress’ | 5G–3 |
| Figure 5G–3: Dress Order No ER2 ‘Emergency Response Emergency Dress’ | 5G–5 |
| Figure 5G–4: Dress Order No ER3 ‘Emergency Response Emergency Dress’ | 5G–7 |
| Figure 5H–4: Dress Order No ME3 ‘Heritage Light Horse Dress’ (1915–18) | 5H–7 |
| Figure 5I–1: Rank slide for Australian Multi-cam Camouflage Uniform/Protective Dress | 5I–3 |
| Figure 5I–2: Patrol Blue White Jacket | 5I–7 |
| Figure 5I–3: Mess Dress White Jacket for female | 5I–10 |
| Figure 5I–4: Mess Dress White Jacket for male | 5I–11 |
| Figure 5I–5: Dress Order No ADFA 3 ‘Scottish Ceremonial Dress’ | 5I–14 |
| Figure 5I–6: Dress Order No ADFA 3 ‘Scottish Ceremonial Dress’ (Drum Major) | 5I–15 |
| Figure 5I–7: Dress Order No ADFA 4 ‘Scottish Mess Dress’ | 5I–18 |
| Figure 5J–1: Collar badge trimmed with scarlet felt | 5J–3 |
| Figure 5J–2: Colour Sergeant Rank | 5J–3 |
| Figure 5J–3: Jacket gold piping | 5J–4 |
| Figure 5J–4: Royal Military College–Duntroon Australian Multi-cam Camouflage Uniform Rank slide | 5J–5 |
| Figure 5J–5: Shoulder Flash | 5J–6 |
| Figure 5J–6: Dress Order No CSC 1 ‘Patrol Blue White Jacket’, with Rifle | 5J–10 |
| Figure 5J–7: Dress Order No CSC 1 ‘Patrol Blue White Jacket’, with Sword | 5J–11 |
| Figure 5J–8: Dress Order No CSC 2 ‘Patrol Blue Jacket’, with Rifle | 5J–14 |
| Figure 5J–9: Dress Order No CSC 2 ‘Patrol Blue Jacket’, with Sword | 5J–15 |
| Figure 5J–10: Dress Order No CSC 3 ‘Polyester Dress–CO’s Order White Dress’, with Rifle | 5J–17 |
| Figure 5J–11: Dress Order No CSC 3 ‘Polyester Dress–CO’s Order White Dress’, with Sword | 5J–18 |
| Figure 5J–12: Dress Order No CSC 4 ‘Polyester Dress–Corps of Staff Cadets General Duty Dress’ | 5J–20 |
| Figure 5J–13: Dress Order No CSC 5 ‘Polyester Dress–Orderly Dress’, Company Orderly | 5J–22 |
| Figure 5J–14: Dress Order No CSC 5 ‘Polyester Dress– Orderly Dress’, Battalion Orderly SGT | 5J–23 |
| Figure 5J–15: Dress Order No CSC 5 ‘Polyester Dress– Orderly Dress’, Battalion Orderly Officer | 5J–24 |
| Figure 5J–16: Dress Order No CSC 6 ‘Polyester Dress–CO’s Order White Dress Cold Weather’, with Rifle | 5J–26 |
| Figure 5J–17: Dress Order No CSC 6 ‘Polyester Dress–CO’s Order White Dress Cold Weather’, with Sword | 5J–27 |
| Figure 5J–18: Dress Order No CSC 7 ‘Polyester Dress–Corps of Staff Cadets General Duty Dress Cold Weather’ | 5J–29 |

| | |
|---|-------|
| Figure 5J–19: Dress Order No CSC 7 ‘Polyester Dress—Corps of Staff Cadets General Duty Dress Cold Weather’, with Jacket Service Dress | 5J–30 |
| Figure 5J–20: Dress Order No CSC 8 ‘Polyester Dress—Orderly Dress Cold Weather’, Company Orderly | 5J–32 |
| Figure 5J–21: Dress Order No CSC 8 ‘Polyester Dress—Orderly Dress Cold Weather’, Orderly Sergeant | 5J–33 |
| Figure 5J–22: Dress Order No CSC 8 ‘Polyester Dress—Orderly Dress Cold Weather’, Orderly Officer | 5J–34 |
| Figure 5K–1: Positioning of embellishments on the Shirt, White with Collar | 5K–3 |
| Figure 5K–2: Positioning of embellishments on the Suit, Athletic Track | 5K–4 |
| Figure 5K–3: Physical Training Dress, with Cap Kepi | 5K–7 |
| Figure 5K–4: Physical Training Dress, with Top, Athletic Track | 5K–8 |
| Figure 5K–5: Physical Training Dress, with Suit, Athletic Track | 5K–9 |
| Figure 5K–6: Physical Training Dress, with suit, Inclement Weather | 5K–10 |
| Figure 5K–7: Physical Training Dress, with T-shirt grey | 5K–11 |
| Figure 5K–8: Battle Physical Training Dress | 5K–12 |
| Figure 5K–9: Battle Physical Training Dress, top track athletic | 5K–13 |
| Figure 5K–10: Battle Physical Training Dress, jacket inclement weather | 5K–14 |
| Figure 5K–11: Battle Physical Training Dress with runners | 5K–15 |
| Figure 5K–12: Dress Order No PT 2 ‘Combat Fitness Leader/ADF Fitness Leader—Physical Training Dress’ | 5K–17 |
| Figure 5K–13: Dress Order No PT 2 ‘Combat Fitness Leader/ADF Fitness Leader—Physical Training Dress’ | 5K–18 |
| Figure 5L–1: Dress Order No CD 1 ‘Clinical Dress’ | 5L–2 |
| Figure 5L–2: Dress Order No CD 1 ‘Clinical Dress’ | 5L–3 |
| Figure 5M–1: Dress Order No MP 1 ‘Royal Australian Corps of Military Police Patrol Order General Duty Dress (polyesters)’ | 5M–2 |
| Figure 5M–2: Dress Order No MP 2 ‘Royal Australian Corps of Military Police Patrol Order Service Dress’ | 5M–4 |
| Figure 5M–3: Dress Order No MP 3 ‘Royal Australian Corps of Military Police Patrol Order General Duty Dress (Australian Multi-cam Camouflage Uniform)’ | 5M–5 |
| Figure 5N–1: Dress Order No CT 1 ‘Catering Dress, Cook’ | 5N–4 |
| Figure 5O–1: Prince of Wales Spur | 5O–5 |
| Figure 5O1–1: Positioning the trade qualification, rising sun, parachute and military skills badges | 5O1–1 |
| Figure 5O1–2: Positioning the retired member insignia badges | 5O1–1 |
| Figure 5O1–3: Positioning the Badges of Rank for Officers and Non-Commissioned Officers | 5O1–2 |
| Figure 5O1–4: Positioning the Collar Badges and Miniature Medals | 5O1–3 |
| Figure 5O1–5: Positioning the Collar, Single Commendation and Infantry Combat Badges, Miniature Medals and Two Unit Citations | 5O1–4 |
| Figure 5O1–6: Positioning the Collar, Two Commendations, Infantry Combat Badge and Aircrew/Parachute Instructor Badges, Miniature Medals and Two Unit Citations | 5O1–5 |
| Figure 5O1–7: Positioning the Collar, Three Commendations, Infantry Combat Badge and Aircrew/Parachute Instructor Badges, Miniature Medals and Three Unit Citations | 5O1–6 |
| Figure 5O1–8: Positioning the Collar, Four Commendations, Infantry Combat Badge and Aircrew/Parachute Instructor Badges, Miniature Medals and Three Unit Citations | 5O1–7 |

| | |
|---|--------|
| Figure 5O1–9: Positioning the Collar, Four Commendations, Infantry Combat Badge and Aircrew/Parachute Instructor Badges, Miniature Medals and Four Unit Citations | 5O1–8 |
| Figure 5O1–10: Positioning the Royal Cypher and Crown Insignia, Two Commendations, Infantry Combat Badge and Aircrew/Parachute Instructor Badges, Miniature Medals and Two Unit Citations | 5O1–9 |
| Figure 5O3–1: Positioning of Embellishments on Mess Dress (Senior Officer) | 5O3–8 |
| Figure 5O3–2: Positioning of Embellishments on Mess Dress (Officer – Lieutenant Colonel and below) | 5O3–9 |
| Figure 5O3–3: Positioning of Embellishments on Mess Dress White Jacket (Commissioned Officers) | 5O3–12 |
| Figure 5O3–4: Positioning of Embellishments on Mess Dress White Jacket (Warrant Officers and Senior Non-Commissioned Officers) | 5O3–13 |
| Figure 6A–1: Method of wearing neck badges | 6A–2 |
| Figure 6A–2: Positioning of full size medals | 6A–4 |
| Figure 6A–3: Court mounted miniature medals | 6A–5 |
| Figure 6A–4: Female ribbon bar configuration | 6A–6 |
| Figure 6A–5: Male ribbon bar configuration | 6A–7 |
| Figure 6A–6: Positioning of medals on Dinner Suit and ladies equivalent | 6A–12 |
| Figure 6A–7: Positioning of medals on Lounge Suit and ladies equivalent | 6A–12 |
| Figure 6B–1: Positioning of Breast Stars, facing the wearer | 6B–3 |
| Figure 6B–2: Wearing of Neck Badges, facing the wearer | 6B–4 |
| Figure 6E–1: Five full size medals are court mounted side by side | 6E–2 |
| Figure 6E–2: Six to nine full size medals are court mounted with ribbon overlap | 6E–3 |
| Figure 6E–3: Ten to fourteen full size medals are court mounted with ribbon overlap | 6E–3 |
| Figure 6E–4: Miniature medals court mounted side by side | 6E–4 |
| Figure 6E–5: Commendation insignia placement on ribands | 6E–5 |
| Figure 6E–6: Commendation insignia placement on ribands of subsequent awards | 6E–5 |
| Figure 6E–7: Positioning of bars | 6E–6 |
| Figure 6E–8: Positioning of clasps on Service medals | 6E–7 |
| Figure 6E–9: Accumulated service device | 6E–8 |
| Figure 6E–10: Assembly and positioning of female and male ribbon bars | 6E–9 |
| Figure 6E–11: Fourth row added to comply with width regulation of lower rows | 6E–9 |
| Figure 6E–12: Positioning of ribbon bar emblems | 6E–10 |
| Figure 6E–13: Positioning of second and subsequent ribbon bar emblems | 6E–10 |
| Figure 6E–14: Positioning of commendation insignia on ribbon bars | 6E–10 |
| Figure 6E–15: Positioning of commendation insignia on ribbon bars for subsequent awards | 6E–10 |
| Figure 6E–16: Positioning of accumulated service device | 6E–11 |
| Figure 6E–17: Positioning of rosettes | 6E–11 |
| Figure 6E–18: Positioning of the Federation Star | 6E–11 |
| Figure 6E–19: Order of Australia ribbon direction and ribbon bar portion | 6E–12 |
| Figure 6E–20: NATO medal clasps and multi-tour indicator | 6E–13 |
| Figure 6E–21: MFO and UN numerals | 6E–14 |
| Figure 6E–22: Standard MFO bronze numeral | 6E–14 |

LIST OF TABLES

| | |
|--|--------|
| Table 2–1: Civilian attire for social functions | 2–10 |
| Table 2–2: Beards | 2–13 |
| Table 3–1: Members entitled to wear the aiguillette | 3–2 |
| Table 3–2: Button sizes | 3–18 |
| Table 3–3: RAAC Regiments entitled to emu tufts | 3–20 |
| Table 3–4: Berets | 3–26 |
| Table 3–5: Designs of identification arm patches | 3–34 |
| Table 3–6: Lanyard colours | 3–42 |
| Table 3–7: Short sleeved khaki polyester shirt sleeve length | 3–57 |
| Table 3–8: Swords, Scabbards and Sword Knots | 3–78 |
| Table 4A–1: Wearing of aircrew badges | 4A–3 |
| Table 4G–1: Wearing of parachute badges | 4G–3 |
| Table 4O1–1: Wearing the Air Dispatcher Badge | 4O1–1 |
| Table 4O2–1: Wearing the Ammunition Technical Officer/Ammunition Technician Badge | 4O2–2 |
| Table 4O3–1: Wearing the Artificer Badge | 4O3–1 |
| Table 4O4–1: Wearing the Conductor Royal Australian Army Ordnance Corps Badge | 4O4–2 |
| Table 4O5–1: Wearing the Drummer Badge | 4O5–1 |
| Table 4O6–1: Wearing the Explosive Detection Dog Badge | 4O–1 |
| Table 4O7–1: Wearing the Explosive Ordnance Disposal Badge | 4O7–1 |
| Table 4O8–1: Wearing the Emergency Response Badge | 4O8–1 |
| Table 4O9–1: Wearing the Ground Crewman Aircraft Support Badge | 4O–2 |
| Table 4O10–1: Wearing the Musician Badge | 4O10–1 |
| Table 4O11–1: Wearing the Operator Petroleum Badge | 4O11–2 |
| Table 4O12–1: Wearing the Parachute Rigger Badge | 4O12–1 |
| Table 4O13–1: Wearing the Piper Badge | 4O13–1 |
| Table 4O14–1: Wearing the PTI Badge | 4O14–1 |
| Table 5–1: Orders of Dress | 5–1 |
| Table 5–2: Dress Order No 1A ‘Ceremonial Parade Service Dress’ | 5–3 |
| Table 5–3: Dress Order No 1B ‘Ceremonial Service Dress’ | 5–8 |
| Table 5–4: Dress Order No 1C ‘General Duty Service Dress’ | 5–13 |
| Table 5–5: Dress Order No 2A ‘Ceremonial Parade Dress’ | 5–17 |
| Table 5–6: Dress Order No 2B ‘Ceremonial Parade Dress Cold Weather’ | 5–21 |
| Table 5–7: Dress Order No 2C ‘Ceremonial Dress’ | 5–24 |
| Table 5–8: Dress Order No 2D ‘Ceremonial Dress Cold Weather’ | 5–28 |
| Table 5–9: Dress Order No 2E ‘General Duty Dress (polyesters)’ | 5–31 |
| Table 5–10: Dress Order No 2F ‘General Duty Dress Cold Weather’ | 5–38 |
| Table 5–11: Dress Order No 2G ‘General Duty Office Dress (polyesters)’ | 5–44 |
| Table 5–12: Dress Order No 3A ‘Ceremonial Safari Suit’ | 5–46 |
| Table 5–13: Dress Order No 4A ‘General Duty Dress (Australian Multi-cam Camouflage Uniform)’ | 5–49 |
| Table 5–14: Dress Order No 4B ‘Field Dress (Australian Multi-cam Camouflage Uniform)’ | 5–52 |
| Table 5–15: Dress Order No 4C ‘Combat Dress (Australian Multi-cam Camouflage Uniform)’ | 5–55 |
| Table 5–16: Dress Order No 5A ‘Armoured Fighting Vehicle Crewman (Australian Multi-cam Camouflage Uniform)’ | 5–58 |

| | |
|---|-------|
| Table 5–17: Dress Order No 5B 'Armoured Fighting Vehicle Crewman, Flame Retardant Combat Dress (Australian Multi-cam Camouflage Uniform)' | 5–60 |
| Table 5–18: Dress Order No 6A 'Mess Dress' | 5–62 |
| Table 5–19: Dress Order No 6B 'Mess Dress White Jacket' | 5–66 |
| Table 5–20: Dress Order No 6C 'Senior Ranks Mess Dress' | 5–71 |
| Table 5–21: Dress Order No 6D 'Mess Dress Army' | 5–75 |
| Table 5–22: Dress Order No 7 'Working/Protective Dress' | 5–79 |
| Table 5–23: Dress Order No 8 'Maternity Dress' | 5–84 |
| Table 5–24: Dress Order No 9 'Aircrew Flame Retardant Flying Dress' | 5–85 |
| Table 5A–1: Orders of Dress worn on particular occasions | 5A–1 |
| Table 5B–1: Special orders of dress worn by special appointments | 5B–2 |
| Table 5B–2: Dress Order No SA1 'Patrol Blue White Jacket' | 5B–2 |
| Table 5B–3: Dress Order No SA 2 'Patrol Blue Jacket' | 5B–6 |
| Table 5C–1: Colour of cap bands and gorget patches | 5C–9 |
| Table 5C–2: Special Orders of Dress | 5C–11 |
| Table 5C–3: Dress Order No SO1 'Patrol Blue White Jacket Senior Officer' | 5C–12 |
| Table 5C–4: Dress Order No SO2 'Patrol Blue Jacket Senior Officer' | 5C–15 |
| Table 5C–5: Dress Order No SO3 'Ceremonial Service Dress General Officer' | 5C–16 |
| Table 5C–6: Dress Order No SO4 'Staff Corps Senior Ranks Mess Dress' | 5C–19 |
| Table 5D–1: Royal Military College Special Orders of Band Ceremonial Dress | 5D–4 |
| Table 5D–2: Dress Order No BC1—No 1 AABC Ceremonial Dress (Royal Military College – Duntroon) | 5D–1 |
| Table 5E–1: Orders for Dress | 5E–6 |
| Table 5E–2: Dress Order No SD1A 'Scottish Ceremonial Parade Service Dress' | 5E–7 |
| Table 5E–3: Dress Order No SD1B 'Scottish Ceremonial Service Dress' | 5E–10 |
| Table 5E–4: Dress Order No SD1C 'Scottish General Duty Service Dress' | 5E–13 |
| Table 5E–5: Dress Order No SD2A 'Scottish Ceremonial Parade Dress' | 5E–15 |
| Table 5E–6: Dress Order No SD2B 'Scottish Ceremonial Dress' | 5E–18 |
| Table 5E–7: Dress Order No SD2C 'Scottish General Duty Dress' | 5E–21 |
| Table 5E–8: Dress Order No SD3 'Scottish Mess Dress' | 5E–23 |
| Table 5E–9: Dress Order No 4A 'General Duty Dress (Australian Multi-cam Camouflage Uniform) Pipes and Drums' | 5E–27 |
| Table 5E–10: Dress Order No SD5W 'Scottish Ceremonial Dress White Jacket' | 5E–28 |
| Table 5E–11: Dress Order No SD5G 'Scottish Ceremonial Dress Green Jacket' | 5E–31 |
| Table 5G–1: Orders of Dress | 5G–2 |
| Table 5G–2: Dress Order No ER1 'Emergency Response Working Dress' | 5G–2 |
| Table 5G–3: Dress Order No ER2 'Emergency Response Emergency Dress' | 5G–3 |
| Table 5G–4: Dress Order No ER3 'Emergency Response Emergency Dress' | 5G–5 |
| Table 5H–1: Orders of Dress | 5H–2 |
| Table 5H–2: Dress Order No ME1A 'Ceremonial Equestrian Dress' | 5H–2 |
| Table 5H–3: Dress Order No ME1B 'Ceremonial Equestrian Service Dress' | 5H–3 |
| Table 5H–4: Dress Order No ME2 'General Duty Equestrian Dress' | 5H–5 |
| Table 5H–5: Dress Order No ME3 'Heritage Light Horse Dress' (1915–18) | 5H–6 |
| Table 5I–1: Orders of Dress | 5I–4 |
| Table 5I–2: Dress Order No ADFA 1 'Patrol Blue White Jacket' | 5I–4 |
| Table 5I–3: Dress Order No ADFA 2 'Mess Dress White Jacket' | 5I–8 |
| Table 5I–4: Dress Order No ADFA 3 'Scottish Ceremonial Dress' | 5I–12 |
| Table 5I–5: Dress Order No ADFA 4 'Scottish Mess Dress' | 5I–16 |
| Table 5J–1: Orders of Dress | 5J–7 |

| | |
|---|-------|
| Table 5J–2: Dress Order No CSC 1 ‘Patrol Blue White Jacket’ | 5J–7 |
| Table 5J–3: Dress Order No CSC 2 ‘Patrol Blue Jacket’ | 5J–12 |
| Table 5J–4: Dress Order No CSC 3 ‘Polyester Dress–CO’s Order White Dress’ | 5J–16 |
| Table 5J–5: Dress Order No CSC 4 ‘Polyester Dress–Corps of Staff Cadets General Duty Dress’ | 5J–19 |
| Table 5J–6: Dress Order No CSC 5 ‘Polyester Dress–Orderly Dress’ | 5J–21 |
| Table 5J–7: Dress Order No CSC 6 ‘Polyester Dress–CO’s Order White Dress Cold Weather’ | 5J–25 |
| Table 5J–8: Dress Order No CSC 7 ‘Polyester Dress–Corps of Staff Cadets General Duty Dress Cold Weather’ | 5J–28 |
| Table 5J–9: Dress Order No CSC 8 ‘Polyester Dress–Orderly Dress Cold Weather’ | 5J–31 |
| Table 5K–1: Dress Order No PT 1 ‘Physical Training Dress’ | 5K–5 |
| Table 5K–2: Dress Order No PT 1 ‘Physical Training Dress’ | 5K–5 |
| Table 5K–3: Dress Order No PT 2 ‘Combat Fitness Leader/ ADF Fitness Leader—Physical Training Dress’ | 5K–16 |
| Table 5M–1: Orders of Dress | 5M–1 |
| Table 5M–2: Dress Order No MP 1 ‘Royal Australian Corps of Military Police Patrol Order General Duty Dress (polyesters)’ | 5M–1 |
| Table 5M–3: Dress Order No MP 2 ‘Royal Australian Corps of Military Police Patrol Order Service Dress’ | 5M–3 |
| Table 5M–4: Dress Order No MP 3 ‘Royal Australian Corps of Military Police Patrol Order General Duty Dress (Australian Multi-cam Camouflage Uniform)’ | 5M–4 |
| Table 5N–1: Orders of Dress | 5N–2 |
| Table 5N–2: Dress Order No CT 1 ‘Catering Dress, Cook’ | 5N–2 |
| Table 5O–1: Patterns of Mess Dress – Senior Ranks Mess Dress and Mess Dress Army | 5O–3 |
| Table 5O–2: Patterns of Mess Dress | 5O–3 |
| Table 5O3–1: Colours and patterns of Corps Mess Jackets and Waistcoats | 5O3–3 |
| Table 5O3–2: Colours of stripes on Blue Trousers, Slacks and Skirts | 5O3–4 |
| Table 5P–1: Tri-Service equivalencies Orders of Dress | 5P–1 |
| Table 6A–1: Summary of requirements for wearing insignia with civilian dress – Day Dress | 6A–10 |
| Table 6A–2: Summary of requirements for wearing insignia with civilian dress – Evening Dress | 6A–10 |

CHAPTER 1

INTRODUCTION

APPLICATION OF THE ARMY DRESS MANUAL

1.1 Army Dress Manual applies to all ranks of the Australian Army and to other persons entitled to wear the Australian Army uniform. This includes those Army members posted to positions outside the Army group and overseas duties. The Army Dress Manual is the authority to wear the Australian Army uniform, the wearing of all items of dress and embellishments, and provides the policy and information for Army dress. The Army Dress Manual does not apply to civilian persons or for those persons not authorised to wear the Australian Army uniform; however, members may apply to the Chief of Army (CA) through Director-General Career Management–Army (DGCM–A) to wear the Australian Army uniform after separation, in accordance with (IAW) paragraph 1.36.

VARIATIONS TO ARMY DRESS MANUAL

1.2 Permanent variations to the Army Dress Manual are not to be made without prior approval of CA. Director-General Army People Capability (DGAPC) is authorised to approve temporary variations to orders of dress for specific occasions, such as unit ANZAC Day ceremonies or weddings.

1.3 A proposal to vary or introduce any item of dress or embellishment to the Army Dress Manual is to be forwarded through the chain of command and Head of Corps (HOC)/Head of Regiment (HOR), to DGAPC for consideration. The chain of command and HOC/HOR are to endorse the submission with comments and recommendations.

1.4 Submissions may be in Minute format and are to detail the change and include justification, and where possible, an indication of any costs or savings likely to result from the proposal.

LAYOUT OF ARMY DRESS MANUAL

1.5 The Army Dress Manual explains all orders of dress—ceremonial, general duty, mess, field, operational, sport and protective. To avoid unnecessary complexity and to ensure that it is easily understood by all personnel, the Army Dress Manual provides the standard information on dress policy that is applied to all Army personnel. The Army Dress Manual is **not** an authority for entitlement purposes. Entitlements can be found within Army Block Scales.

INTERPRETATION OF THE ARMY DRESS MANUAL

1.6 The Army Dress Manual is to be interpreted as positive instructions, meaning if a situation is **not** specified in the Army Dress Manual, it is therefore **prohibited**; however, elements of this manual provide specific direction to the reader.

1.7 Tables throughout the Army Dress Manual list items authorised to be worn with particular orders of dress. Where more than one type of item is authorised, a

commander of a sub-unit, unit, or formation may, order a particular type of item to be worn for a particular duty. Those same commanders may order that any item of uniform is to be worn as part of an authorised order of dress on a particular occasion.

AUSTRALIAN REGULAR ARMY

1.8 Members of the Australian Regular Army (ARA) are to wear the Australian Army uniform when on duty. In exceptional circumstances, approval to wear civilian clothing may be given by a commander, Commanding Officer (CO) or Officer Commanding (OC).

ACTIVE RESERVE

1.9 Members of the Army's Active Reserve are to wear the Australian Army uniform when on duty. A Commander or CO may:

- a. Authorise in writing, the wearing of civilian clothing in circumstances such as:
 - (1) when a member has not been issued all items of uniform and embellishments on enlistment
 - (2) when a member has not been able to change into uniform as a result of unavoidable circumstances.
- b. Authorise in writing, the wearing of the Australian Army uniform at significant events, while the member is performing a specific voluntary unpaid duty/attendance.

STANDBY RESERVE

1.10 Members of the Standby Reserve are to wear the Australian Army uniform when on duty or when authorised by a Senior Commander for specific events.

AUSTRALIAN ARMY CADETS

1.11 Members of the Australian Army Cadets (AAC) are authorised to wear the Australian Army uniform, IAW AAC dress policy which is subordinate, but conforms to the Army Dress Manual. Variations to AAC dress policy are to be forwarded to DGAPC, before implementation within AAC.

CIVILIAN CLOTHING

1.12 Civilian clothing may be worn by members when on duty, IAW paragraph 1.9. Personnel wearing civilian attire on duty are to present a neat, clean and non-offensive appearance.

1.13 Visible civilian items of apparel are not to be worn with the Australian Army uniform, except where specifically authorised in the Army Dress Manual. Items of any military uniform are not to be worn with civilian attire, and the mixing of orders of dress or mixing military and civilian clothing is not permitted, except wearing of the Garrison jacket.

STANDARDS AND RESPONSIBILITIES

1.14 The image, pride and esteem of the Australian Army are highly dependent upon the maintenance of the highest standards of dress, appearance, grooming and bearing that is expected of a professional military force. It is the responsibility of all personnel to maintain their uniform in good order and repair, and present the highest possible standards of appearance. Alteration to the basic design of the issue Australian Army uniform is prohibited, eg removal of pockets, removal/cutting off sleeves/trouser legs, etc. Special consideration is given where the uniform may be altered on specific occasions by attaching the appropriate poppy/badge/ribbon/pin on or above the left breast pocket, or on the left lapel portion of the collar when general duty orders of dress is worn or ceremonial orders of dress at commemorative services such as ANZAC Day or Remembrance Day when not on parade. Only one poppy/badge/ribbon/pin is to be worn on the Army uniform at any one time with the exception of serials b and c whereby both poppies may be worn during the prescribed period. If members wish to wear the Purple Poppy it must be worn with the Red Poppy. When involved in authorised charitable activities, members are to uphold their appearance, and maintain the reputation and standards of the Australian Army. The wearing of a poppy/badge/ribbon/pin is only authorised on the following occasions:

- a. ANZAC Day (25 April, to include the week of 25 April) – poppy or badge
- b. Remembrance Day (Red Poppy) (11 November, to include the week of 11 November) – poppy or badge
- c. Remembrance Day (Purple Poppy) (11 November, to include the week of 11 November) – poppy or badge
- d. Legacy Week – poppy or badge
- e. Breast Cancer Pink Ribbon Day (last Monday in October, including the remainder of that week) – Pink Ribbon
- f. Reconciliation Week (27 May–03 June) – Indigenous Pin
- g. National Aborigines and Islanders Day Observance Committee (NAIDOC) Week (first or second week of July) – Indigenous Pin

1.15 Items of clothing or equipment which are not of an approved design or material are not to be worn as part of the Australian Army uniform.

1.16 While recognising the standards of society, the traditional military standards have proved their value in fostering group identity and morale.

1.17 Members wearing the Australian Army uniform **are not to:**

- a. Army personnel are not authorised to consume or purchase alcohol while wearing military uniform in a public place on ANZAC Day or other days of national or Defence significance
- b. chew gum, slouch, saunter, place hands in pockets

ADM

1–4

- c. smoke in the street, jay walk or loiter
- d. walk/march around whilst using a mobile phone or similar device
- e. walk/march around whilst wearing a Bluetooth mobile headset or similar type device
- f. undertake any similar deportment which detracts from a military appearance in the eyes of the public.

1.18 Unless otherwise stated, orders of dress apply to all Defence personnel.

UNIFORM ALLOWANCE

1.19 Uniform Allowance is paid to ARA members for replacement and maintenance of uniforms. The allowance does not cover laundry or dry cleaning costs and is reviewed regularly.

SPECIAL APPOINTMENTS

1.20 Specific orders of dress, embellishments and accoutrements are worn by serving and selected personnel in special appointments.

1.21 A special appointment is one of those listed as follows:

- a. an aide-de-camp (ADC) to the Sovereign
- b. an officer holding a personal appointment to the Sovereign
- c. an Equerry to His or Her Royal Highness or Extra Equerries to other members of the Royal Family
- d. an ADC to, or an officer on the personal staff of the Governor-General or the Governor of a State or Administrator of an Australian Territory
- e. the Comptroller to the Governor-General
- f. an Australian Army force or component commander – Major General (MAJGEN) rank and above
- g. a military assistant and/or ADC to the Chief of the Defence Force
- h. a military assistant and/or ADC to the Vice Chief of the Defence Force
- i. a military assistant and/or ADC to the CA
- j. the escort officer to the Minister for Defence, or the Minister for Defence Personnel, Materiel and Science or the Minister for Veterans' Affairs
- k. the Director of Protocol and Visits (Headquarters Australian Defence Force)
- l. a military assistant and/or ADC to a General officer

ADM

1–5

- m. an officer nominated as an escort officer to a visiting officer of MAJGEN rank or above.

SELECTED PERSONNEL

1.22 Selected personnel are those who fill one of the following employment positions:

- a. Director-General Career Management–Army
- b. Director-General Training
- c. Regimental Sergeant Major of the Army
- d. **Royal Military College of Australia (RMC–A) and Royal Military College–Duntroon (RMC–D):**
 - (1) Commandant (COMDT) RMC–A
 - (2) CO RMC–D
 - (3) Director of Military Art
 - (4) Regimental Sergeant Major (RSM) RMC–A
 - (5) RSM RMC–D
 - (6) officers, warrant officers, senior non-commissioned officers and staff cadets posted to the Corps of Staff Cadets
 - (7) officers nominated by the COMDT for host/escort duties at appropriate ceremonial occasions.
- e. **Australian Defence Force Academy:**
 - (1) COMDT and Deputy COMDT (when filled by Army)
 - (2) SO3 Cadets
 - (3) Academy Sergeant Major (when filled by Army)
 - (4) Regimental Sergeant Major – Officer Training College
 - (5) all Army officer cadets (OCDT) and other Army personnel fulfilling parade appointments
- f. All Tier C RSMs
- g. RSM Ceremonial–Army
- h. RSM Ceremonial–ADF.

1.23 Philanthropic representatives are not authorised to wear any items of Australian Multi-cam Camouflage Uniform (AMCU). The equipment that may be

issued to philanthropic representatives and the policy of wearing other associated dress is in the [Philanthropic Manual](#)⁵.

1.24 Philanthropic representatives are authorised to wear general duty and ceremonial orders of dress but only IAW [Philanthropic Approved Clothing List](#)⁶. General duty and ceremonial orders of dress may be worn with orders, decorations, medals and ribbon bar as appropriate to dress orders, but without any Australian Army embellishments, titles or badges of rank.

1.25 Grading/status badges provided by the approved philanthropic organisation may be worn, IAW the status of the philanthropic representative.

1.26 Philanthropic representatives who accompany the ADF on overseas operations are to wear protective dress and equipment, IAW Chief of Joint Operations Command directives for the designated Area of Operations.

HONORARY COLONEL/COLONEL COMMANDANT AND OTHER HONORARY APPOINTMENTS

1.27 An officer or person appointed honorary Colonel (COL), COLCOMDT or Regimental COL of a Corps or Regiment, may wear uniform when attending activities of the Corps or Regiment. The uniform and embellishments of the Corps or Regiment, including lanyard, with the badges of rank of a COL are worn, but without coloured cap-band, gorget, patches or Senior officers cap badge. Alternatively, an officer may wear the badges of rank and other insignia of the rank which they held when serving, Inactive Reserve or of the military rank or title granted on retirement. For example; a retired Brigadier may wear the embellishments of that rank, and would not wear any Corps/Regiment embellishments such as shoulder titles, lanyard or Corps/Regiment badges. Regardless of rank, the appropriate special to Corps/Regiment beret may be worn, IAW Corps custom and these orders. Honorary appointments wear either the mess dress orders of dress of the Corps with the rank insignia of COL or the mess dress orders of dress to which they are entitled by virtue of their rank on retirement.

1.28 Honorary appointments are to wear the orders of dress, IAW [Annex 5C](#) and [Army Standing Instruction \(Personnel\) Part 12 Chapter 6—Honorary Appointments](#)⁷.

DRESS AT RECEPTIONS

1.29 Dress for members invited to attend Australian (both Federal and State) and foreign receptions, will normally be indicated on the invitation. If doubt exists as to the correct order of dress, the advice of superior headquarters or DGAPC is to be sought.

⁵<http://intranet.defence.gov.au/home/documents/data/DEFPUBS/DEPTMAN/PHILOMAN/PHILOMAN.pdf>

⁶ <http://intranet.defence.gov.au/DRMS/uR2519/AF16124270.pdf>

⁷ <https://objective/id:R26414402>

FOREIGN RECEPTIONS

1.30 Dress for attendance at Armed Forces and National Day Receptions will normally be indicated on invitations, eg 'Uniform/Lounge Suit/National Dress'. However, if no preferred dress is given, the appropriate Australian Army uniform is to be worn.

1.31 Dress for receptions other than Armed Forces or National Day will also normally be indicated on invitations. However, if no preferred dress is given, Service personnel attending evening receptions are to wear lounge suit.

AUSTRALIAN RECEPTIONS

1.32 When a State Reception is hosted by an Australian Government representative, where awards or prizes are to be presented as a result of Service Recognition, eg Humanitarian Overseas Service Medal for Humanitarian Assistance, the dress is to be the appropriate Australian Army uniform. If the reception is to be for the receiving of a civilian award, eg Young Australian of the Year, the most outstanding charity fund raiser, the recipient is to wear lounge suit.

DISCRETIONARY JUDGMENT

1.33 Should guests at official receptions have an immediately prior or subsequent engagement requiring the wearing of an order of dress other than that specified on the invitation, it is convention that the host be advised of the order of dress that will be worn by the guest.

ORDERS OF DRESS WORN ON PARTICULAR OCCASIONS

1.34 The dress to be worn by all personnel on particular occasions is in [Annex 5A](#). If doubt exists as to the correct order of dress, the advice of the chain of command or DGAPC is to be sought.

WEARING OF UNIFORMS AFTER SEPARATION

1.35 A member may apply in writing to DGCM-A through DPSRM-A, for permission to wear mess dress to attend a formal dinner that is held on a Military Base. Approval is not automatic. If approval is granted, there is no entitlement at Commonwealth expense for maintenance or issue of uniform or associated embellishments. Mess dress is to be worn IAW [Annex 5O](#).

1.36 Permission will not be given to wear mess dress to civilian venues or to wear military uniform to ANZAC Day and Remembrance Day events or any other occasion.

1.37 Officers authorised to use the post-nominal 'Retd' are to seek an issue of the 'R' insignia embellishment prior to separation.

CHAPTER 2

INTERPRETATION OF THE ARMY DRESS MANUAL

The Army Dress Manual is to be interpreted as positive instructions, meaning if a situation is **not** specified in the Army Dress Manual, it is therefore **prohibited**; however, elements of this manual provide specific direction to the reader.

WEARING OF UNIFORM

ALIGNMENT OF THE UNIFORM

2.1 Shirts and jackets are to be worn with the button line positioned centrally in front of the body. The outer edge of the buttoned shirt is to be vertically aligned with the trouser fly. The buckles of the trouser belt, ceremonial belt and Sam Browne Belt are to be positioned centred with the buttons of jackets and shirts, or centrally in the front of the body when wearing sweaters.

IRONING OF THE UNIFORM

2.2 As a minimum standard, all uniforms except Field Dress Australian Multi-cam Camouflage Uniform (AMCU) and Combat Dress Australian Multi-cam Camouflage Uniform (AMCU) are to be ironed free of wrinkles. The collars of shirts are to be ironed flat against the body of the shirt, with creases extending upward from the first button/button hole below the collar, to the base of the collar. The polyester shirt sleeves (long and short) are to be ironed with a single crease from the centre of the epaulette to the hem or cuff. The yoke of the shirt is to be ironed flat in context with the back of the shirt. No other creases are to be ironed into shirts. Trousers and protective dress shorts are to be ironed with a single crease, centrally in the front and rear of each leg. Skirts are not to have any ironed creases.

2.3 AMCU when worn as General Duty Dress (AMCU) is to be clean and lightly pressed to remove wrinkles with the collar ironed flat. No creases are to be ironed into sleeves or to the back of the uniform, and under no circumstances are AMCU garments to be starched.

SPECIFIED OCCASIONS

2.4 Orders of dress to be worn on specific occasions are in [Annex 5A](#) and [Annex 5B](#).

2.5 When being received on parade, officers are to be dressed in the same order of dress as those on parade. All spectators at a parade are to be dressed in the matching spectator uniform to those on parade. The Australian Army uniform is worn, in accordance with (IAW) [Chapter 5](#) and as follows:

- a. **Ceremonial Dress.** Ceremonial Dress is worn for all ceremonial and State occasions.

- b. **Mess Dress.** Mess Dress is worn for formal and semi-formal mess functions, and organised balls. A Commanding Officer (CO) may authorise the wearing of equivalent civilian clothes on appropriate occasions.
- c. **Australian Multi-cam Camouflage Uniform.** AMCU when worn in the barracks environment is referred to as General Duty Dress (AMCU). General Duty Dress (AMCU) may be worn in public. General Duty Dress (AMCU) is mandated across Army as dress of the day, and is authorised as the dress of the day for Army personnel serving in Non-Army Groups, at the discretion of respective Army Admin CO. This order of dress can be worn when travelling in public, including domestic civil aircraft. This dress is also worn on the first working day when reporting for duty on posting. AMCU is not to be worn when Protective Dress is to be worn. The AMCU shirt and trousers when worn are to be, within reason, matching in colour, style and age. Shirts and trousers that do not meet this criterion are not to be worn in the barracks environment; however, may be worn as Field Dress (AMCU).
- d. **Field Dress.** Field Dress is worn when on operations (including domestic and regional), exercises, field related duties, field training and in the barracks environment.
- e. **Combat Dress.** Combat Dress is worn when body armour is being worn. The Shirt AMCU Combat is **only** to be used and worn when the user is wearing body armour IAW [Chapter 5](#), Dress Order No 4 C. Trousers AMCU Combat may be worn with the AMCU Field Shirt in all environments including the barracks environment (alternative form of Dress Order 4A). A Commanding Officer (CO) may exercise their command discretion towards the wearing of these items.
- f. **Protective Dress.** Protective Dress is worn when engaged in activities such as vehicle maintenance, catering, medical and dental duties and other tasks which may cause damage to other orders of dress, or when required for workplace health and safety reasons. Both the AMCU Wet Weather Jacket and AMCU General Purpose Jacket may be worn with this order of dress. Protective Dress is not to be worn in public except when in direct fulfilment of a task, described in this paragraph. Dirty, untidy or spoiled dress is not to be worn at any time in public but may be worn in the workshop. Personnel may wear Protective Dress whilst travelling to and from duty/home inside a private vehicle or on a motorcycle but not on public transport.
- g. **General Duty Dress (polyesters).** General Duty Dress (polyesters) is worn for attending representational activities only and by exception where polyester uniform is the more appropriate option, due to the nature of the appointment.
- h. **Australian Multi-Camouflage Pattern Ensemble.** Australian Multi-Camouflage Pattern (AMP) Ensemble is to be worn by Special Operations Command (SOCOMD) personnel only within Raise Train and Sustain and operational environments. The uniform may be worn with or without knee and elbow protection inserts, dependant on the nature of duties. The AMP shirt is to be embellished with badges of rank, Operational Shoulder Patch, National Distinguishing Sign—Australian National Flag and nametag. The trousers may

be worn with or without a combat belt and it is to be bloused over the combat boot; however, it may be worn un-bloused when operational tasking or duty permits.

MEMBERS ON POSTING

2.6 Members of the Australian Regular Army (ARA) and Army Reserve (ARes) posted or attached to a Unit or Regiment of a Corps other than their parent Corps, are to continue to wear the badges of their parent Corps. The exception to this is an Officer or Warrant Officer posted into a Commanding Officer, Officer Commanding or Sergeant Major position. Members in these appointments may wear the Unit or Regiment badges and shoulder titles for the duration of their posting. For example – A Royal Australian Armoured Corps (RAAC) Officer posted as the Commanding Officer of a Royal Australian Infantry Unit (51 Far North Queensland Regiment). Where the gaining unit has a Unit (not Corps) lanyard, the Unit lanyard is to be worn for the tenure of the posting, except in the following circumstances:

- a. Members of a Corps based sub-unit within a Unit or Regiment are to wear the lanyard of their parent Corps applicable to that sub-unit, eg 2/10 Light Battery, Royal Australian Artillery within 5/6 Royal Victorian Regiment (RVR) are to wear the parent Corps (white) lanyard, IAW [Chapter 3](#).

CORPS OF STAFF CADETS

2.7 Members of the Corps of Staff Cadets are authorised to wear the Hat Khaki Fur Felt (KFF) with the following variations:

- a. brim down, except when participating as a part of a National Contingent or on ANZAC Day, and the chinstrap buckle on the right-hand side
- b. distinctive olive drab puggaree.

ROYAL AUSTRALIAN ARMoured CORPS, ROYAL AUSTRALIAN REGIMENT, ROYAL AUSTRALIAN INFANTRY CORPS, AUSTRALIAN ARMY AVIATION, ARMY RESERVE INFANTRY REGIMENTS, UNIVERSITY REGIMENTS, REGIONAL FORCE SURVEILLANCE UNITS AND SPECIAL OPERATIONS COMMAND

2.8 The wearing of specific embellishments by RAAC, Royal Australian Regiment (RAR), Royal Australian Infantry Corps (RA Inf), Australian Army Aviation (AA Avn), Army Reserve Infantry Regiments, University Regiments (UR), Regional Force Surveillance Units (RFSU) unit personnel and SOCOMD is to be as follows:

- a. **Royal Australian Armoured Corps members.** RAAC members posted to RAAC regiments are to wear the badge and shoulder title of their respective regiment. At all other times, except of a SOCOMD posting, the RAAC badge and shoulder title are to be worn.

For example: a RAAC member posted to 2nd Cavalry Regiment (2 CAV) is to wear the 2 CAV badge, shoulder title and RAAC lanyard. The member, who is then posted to HQ 3rd Brigade, is to wear the RAAC badge, RAAC

shoulder title and RAAC lanyard. A RAAC member posted to a SOCOMD unit wears the embellishments of that unit for the duration of the posting.

- b. **Australian Army Aviation members.** AA Avn members posted to AA Avn regiments are to wear the badge and shoulder title of their respective regiment. At all other times, except of a SOCOMD posting, the AA Avn badge and shoulder title are to be worn.

For example: an AA Avn member posted to 1 Avn Regt is to wear the 1 Avn Regt badge, 1 AVN shoulder title and AA Avn lanyard. The member, who is then posted to AA Avn Army Headquarters, is to wear the AA Avn badge, AA Avn shoulder title and AA Avn lanyard. AA Avn member posted to a SOCOMD unit wears the embellishments of that unit for the duration of the posting..

- c. **Royal Australian Regiment members.** RAR members are to wear the RAR badge, shoulder title and lanyard of their battalion/unit. On posting from an RAR battalion/unit, members retain the RAR badge and shoulder title but wear the RA Inf lanyard. If posted to another RA Inf regiment/unit, which has specific regiment/unit badge, shoulder title and lanyard, those embellishments are to be worn. On subsequent posting to a non-RA Inf unit, the RAR badge, shoulder title and RA Inf lanyard are to be worn.

For example: a RAR member posted to 2 RAR is to wear the RAR badge, RAR shoulder title and 2 RAR lanyard. The member, who is then posted to 5/6 RVR, is to wear the RVR badge, RVR shoulder title and 5/6 RVR lanyard. The member, who is then posted to the School of Infantry, is to wear the RAR badge, RAR shoulder title and RA Inf lanyard.

- d. **Royal Australian Infantry.** RAInf members are to wear the regimental badge, shoulder title and lanyard of their battalion/unit. On posting from the regiment battalion/unit, members retain their regimental badge and shoulder title but wear the RA Inf lanyard. If posted to another RA Inf regiment/unit, which has specific regiment/unit badge, shoulder title and lanyard, those embellishments are to be worn. On subsequent posting to a non-RA Inf unit, their regimental badge, shoulder title and RA Inf lanyard are to be worn.

For example: a RWAR member posted to 42 RQR is to wear the RQR badge, RQR shoulder title and 42 RQR lanyard. The member, who is then posted to 5/6 RVR, is to wear the RVR badge, RVR shoulder title and 5/6 RVR lanyard. The member, who is then posted to the School of Infantry, is to wear the RWAR badge, RWAR shoulder title and RA Inf lanyard. A RTR member who is posted to HQ 4 BDE is to wear the RTR badge and shoulder title with the RAInf lanyard. This allows both SERCAT 5 and 7 members to remain aligned to their parent infantry regiment.

- e. **University Regiments members.** RAR and RA Inf members posted to UR are to wear UR badge, shoulder titles and UR lanyard. Non-RA Inf members posted to UR are to wear their Corps badge and shoulder title but wear the UR Unit Colour Patch (UCP) and UR lanyard. Officer Cadets under training are to wear the UR badge, shoulder title, lanyard and UCP.

For example: a RAAC member posted to Sydney University Regiment (SUR) is to wear the RAAC badge, RAAC shoulder title, SUR UCP and SUR lanyard.

- f. **Training establishment members.** Members posted to a training establishment position, ie Army Recruit Training Centre (ARTC), Army Logistic Training Centre, Warrant Officer and Non-Commissioned Officer Academy are to wear their Corps or RAR badges, Corps or RAR shoulder title and Corps or RA Inf lanyard but wear the UCP of that unit.

For example: a RAR member posted to ARTC is to wear RAR badges, RAR shoulder titles, ARTC UCP and RA Inf lanyard.

- g. Tier C Regimental Sergeant Majors (RSMs) no longer in a Tier C appointment are to revert to their Corps or RAR badges, IAW paragraph 2.6.
- h. **Special Operations Command.** IAW [Annex 2A](#).

RESTRICTIONS ON WEARING THE UNIFORM

2.9 The Australian Army uniform **is not to be** worn:

- a. at a meeting or demonstration held for a religious or political purpose other than official duties
- b. at a civil law court unless authorised by the commander or CO
- c. where contempt is likely to be directed at the uniform or member under section 84 of the [Defence Act 1903](#)⁸
- d. when participating in non-official recognised activities, unless authorised in writing by a CO.

DRESS IN THE OFFICE ENVIRONMENT

2.10 A Service Dress jacket or Utility jacket may be removed in an office environment. Jackets are to be worn outside the defined office environment. When the jacket is removed in an office environment, the shirt polyester is not to be embellished, but rank insignia is to be worn.

DRESS IN OFFICERS', SERGEANTS' MESSES AND SOLDIERS' CLUB

Dress standards

2.11 High standards of dress are to be applied in Officers' and Sergeants' Messes and Soldiers' Clubs to maintain the image and status of messes, clubs and customs

⁸ http://www.austlii.edu.au/au/legis/cth/consol_act/da190356/

of the Army. Standards are defined as: presentation, cleanliness, state of good repair and non-offensive.

Dress style

2.12 The style of dress to be worn in Officers' and Sergeants' Messes and Soldiers' Clubs are to be determined by the Supervising Officer, RSM or President of the Mess Committee and are authorised by the CO of the mess or club. Styles are to reflect the nature of functions or activity, living accommodation, geographic location, climate and status of the mess or club. Styles are to be promulgated for specific functions or duration.

2.13 The following styles **are not to** be worn: singlets, thongs, trousers worn without a belt, obscene or offensive motifs and like items.

SERVICE MEMBERS VISITING MESSES

2.14 It is the responsibility of Service members to check in advance, the local mess rules and comply with those rules when visiting a mess.

DRESS IN VEHICLES

2.15 Personnel wearing the Australian Army uniform whilst driving or travelling in military or civilian vehicles are not to wear headdress except, IAW [Chapter 3](#). The uniform is not to be modified or adapted, ie removing the shirt whilst driving any vehicle.

DRESS FOR PHYSICAL TRAINING

2.16 Members participating in physical training (PT) as part of a formed body are to wear uniform standards of dress as follows:

- a. **Combat or Battle Physical Training.** AMCU with equipment as ordered, with the issue green T-shirt or Army logo green T-shirt or a unit approved T-shirt or suitable top (**not** a singlet or muscle shirt), which provides suitable protection to the individual including the torso, arms and elbows, dependant on the activity being conducted as directed. Combat or Battle PT Dress is not to be worn in public, unless conducting scheduled PT sessions. When there is a requirement to wear running shoes with AMCU the wearing of PT socks (white or black) or khaki is permitted. The AMCU Combat shirt **is not to** be worn during PT or Battle PT when body armour is not being worn IAW [Chapter 5](#), Dress Order No 4 C. Females are to wear appropriate under garments brassier/sport brassier when undertaking defence activities.
- b. **Aerobic.** The issue green T-shirt, Army logo green T-shirt, black Army shorts and white socks or black socks are worn during the conduct of PT. However, the unit CO/OC may approve a style and design for unit/sub-unit PT T-shirt and shorts, and may be worn in place of the issued PT attire, which members are to purchase and wear at their own expense. All members are to wear suitable underwear with PT attire. Individuals have the option to forego PT shorts over bicycle shorts, compression pants/shorts, active wear or similar. When PT shorts are not worn over the top, the bicycle shorts, compression

pants/shorts are to be mid-thigh or longer in length and are not to have the 'gather design' in the buttocks of the pants. Bicycle shorts, compression pants/shorts, active wear is to be plain black, navy blue or dark green and not see-through or transparent. Approved/authorised headwear is to be worn where appropriate, IAW [Chapter 3](#). Females are to wear appropriate under garments brassier/sport brassier when undertaking defence activities.

- c. **Team sports (including contact sports).** Team uniforms, which meet the accepted standard and strip for the approved sports are permitted. Consideration should be given to the climate conditions, eg indoor/outdoor activities. Mouth guards and all mandated safety equipment are to be worn by members while participating in approved team/contact sports, including sun protection. Females are to wear appropriate under garments brassier/sport brassier when undertaking defence activities.
- d. **Water sports.** Male members are authorised to wear plain black or navy blue shorts (with underwear or bathers) or plain black, navy blue or dark green 'Speedo' type bathers when conducting scheduled water sports or PT sessions. A plain black, navy blue or dark green 'rash shirt' or an equivalent may be worn for sun protection. Multi-coloured board shorts, bathers or other types of garments, designs, patterns or colours **are not** authorised to be worn. Female members are authorised to wear a plain black, navy blue or dark green single-one-piece bathing suit (with or without PT shorts) when conducting scheduled water sports or PT sessions. A sports brassiere/crop top (the same colour as the bathing suit) may be worn underneath. Female members are also entitled to wear, at their own expense, a plain black, navy blue or dark green two-piece sports/triathlon swimming costume. This includes a crop-top and 'boy shorts' or 'speedo' type bathers. A plain black, navy blue or dark green 'rash shirt' or an equivalent may be worn for sun protection. Multi-coloured board shorts, bikinis or other types of garments, designs, patterns or colours **are not** authorised to be worn.

2.17 Members participating in individual PT activities during on-duty hours are to wear the appropriate dress for the activity, IAW paragraph 2.16; however individuals have the option to forego PT shorts over bicycle shorts, compression pants/shorts, active wear or similar. Bicycle shorts, compression pants/shorts, active wear is to be plain black, navy blue or dark green and not see-through or transparent. Headphones or iPods are not to be worn under any circumstances whilst undergoing PT, except when conducting individual PT inside a gymnasium or designated running track away from traffic. Members participating in individual indoor weight training during on-duty hours may wear the appropriate clothing, eg singlet or muscle shirt. Once the individual has completed a weight training session, he/she is to wear the appropriate outdoors PT attire, eg T-shirt. Singlets and muscle shirts **are not** to be worn as PT attire when conducting scheduled PT sessions. Singlets and muscle shirts **are not** to be worn at any other time by members on Defence establishments, except those specified within this manual. Females are to wear appropriate under garments brassier/sport brassier when undertaking activities on defence establishments.

MOTORCYCLES AND BICYCLES

2.18 A member travelling on a motorcycle or bicycle must wear individual safety or protective equipment, IAW civil law. The prescribed order of dress is to be restored

as soon as practicable at the completion of the journey. Headdress is not be worn whilst carrying a motorcycle helmet in the circumstances in [Chapter 3](#). IAW Defence WHS, covering the use of motorcycles, long trousers are to be worn whilst on a motorcycle.

TRAVEL ON SERVICE AIRCRAFT

2.19 Dress for travel on Royal Australian Air Force (RAAF), Service chartered commercial aircraft or other military aircraft is to be as follows:

- a. **Internal flights.** General Duty Dress (AMCU) is to be worn.
- b. **External flights.** The normal dress for travel on international flights is civilian clothing. Exceptions to this requirement will be advised by RAAF at the initial check-in, one day prior to flight departure. Civilian dress must conform to the following minimum standards:
 - (1) trousers with belt, may include jeans
 - (2) shirts with properly formed collars
 - (3) jackets, pullovers, etc as required
 - (4) fully enclosed shoes, (sandals and thongs are not to be worn).

2.20 **Operational/exercise deployment.** Field and Combat Dress (AMCU), when authorised is to be worn.

TRAVEL ON PUBLIC OR COMMERCIAL TRANSPORT WITHIN AUSTRALIA

2.21 When travelling for Service reasons on domestic air travel/civil aircraft, General Duty Dress (AMCU) or civilian clothing, IAW paragraph 2.19(b) may be worn. Personnel wearing General Duty Dress (AMCU) on commercial air transport, is to be clean and ironed, IAW paragraph 2.3. In exceptional circumstances and for practical reasons, personnel entitled to wear the Sam Browne Belt in [Chapter 3](#) may be exempt from wearing the belt with general duty orders of dress, when travelling on any aircraft who are subsequently required to attend an activity after such travel. In this instance, the waist belt 32 mm is to be worn in lieu of the Sam Browne Belt. In exceptional circumstances and for practical reasons, personnel entitled to carry the pace stick in [Chapter 3](#) may be exempt from carrying the stick with general duty orders of dress, when travelling on any aircraft who are subsequently required to attend an activity after such travel. In this instance, the entitled person is not to carry the pace stick when the waist belt 32 mm is to be worn in lieu of the Sam Browne Belt.

TRAVEL ON PUBLIC OR COMMERCIAL TRANSPORT OUTSIDE AUSTRALIA

2.22 When posted or visiting overseas, a member travelling on duty is to wear civilian clothing, IAW paragraph 2.19(b), unless otherwise authorised.

2.23 While in a foreign country, all ranks are to wear the Australian Army uniform on appropriate occasions when on duty or visiting foreign military establishments. Advice should be sought from the local Australian military or diplomatic representative if there is doubt. The Australian Army uniform is not to be worn in a foreign country when not on duty. In exceptional circumstances and for practical reasons, personnel entitled to wear the Sam Browne Belt in [Chapter 3](#) may be exempt from wearing the belt with general duty orders of dress, when travelling on any aircraft who are subsequently required to attend an activity after such travel. In this instance, the waist belt 32 mm is to be worn in lieu of the Sam Browne Belt. In exceptional circumstances and for practical reasons, personnel entitled to carry the pace stick in [Chapter 3](#) may be exempt from carrying the stick with general duty orders of dress, when travelling on any aircraft who are subsequently required to attend an activity after such travel. In this instance, the entitled person is not to carry the pace stick when the waist belt 32 mm is to be worn in lieu of the Sam Browne Belt.

MILITARY WEDDINGS

2.24 All members are to apply for CO approval to wear a military uniform at a wedding. Where no entitlement for issue exists, and the member's commander or CO has approved for the wearing of a uniform, the uniform is to be purchased at the members' expense or loaned on short-term loan. Requests to purchase/loan a uniform are to include the commanders or COs approval and forwarded to Director Logistics–Army. If approved, the Australian Army uniforms to be worn at military weddings are as follows:

- a. **Official party.** Dress Order No 1A or 1B and Dress Order No 6A or 6D.
- b. **Service guests.** The appropriate civilian attire or IAW the official party.

CIVILIAN FUNERALS

2.25 A CO may give approval for a member to wear the appropriate Australian Army uniform at a civilian funeral.

FORMS OF CIVILIAN ATTIRE FOR SOCIAL FUNCTIONS

2.26 The various forms of civilian attire for social functions that require civilian dress to be worn are in Table 2–1.

Table 2-1: Civilian attire for social functions

| Serial (a) | Dress (b) | Gentlemen (c) | Ladies (d) | Remarks (e) |
|---------------|---------------|--|--|--|
| 1 | Planters | a. Open-neck, short sleeve shirt with slacks b. Long sleeve shirt and tie with slacks | Smart casual dress; skirt and blouse or tailored slacks and blouse | a. Sometimes referred to as 'Territory Rig' b. Depends on the local custom |
| 2 | Morning Dress | Grey or black Morning jacket and striped or plain trousers | Smart day-wear, ie two piece suit or a dress | Nil |
| 3 | Lounge Suit | Matching two or three piece business suit | Smart day-wear, ie two piece suit or a dress | Nil |
| 4 | Day Dress | Lounge Suit | Smart day-wear, ie two piece suit or a dress | Nil |
| 5 | After Five | Lounge Suit | Cocktail dress | Usually Cocktail parties |
| 6 | Dinner Suit | A black 'formal' suit with a black bow tie | A 'formal' dress | a. May also be referred to as 'After Six' b. May also be expressed as either 'Dinner Jacket' or 'Black Tie' |
| 7 | Evening Dress | A black 'formal' suit, having a coat with 'tails', and a white bow tie | Formal long dress, with gloves | a. May also be expressed as 'White Tie' |
| 8 | Coat and tie | A Sports jacket, tie and slacks | Smart casual, eg dress or skirt or tailored slacks and top | Jeans are not to be worn |
| 9 | Casual wear | Neat open-neck shirt, long or short sleeve and slacks | Smart casual, eg skirt, slacks or shorts and top | Shorts or smart jeans may be worn |

COSMETICS

2.27 Conservative colour shades and style cosmetics may be worn when wearing the Australian Army uniform. False eyelashes, heavy eyeliner and excessive

application of facial make-up **are not to** be worn. The colours of fingernail varnish permitted to be worn are in Figure 2-1. Men when wearing the Australian Army uniform **are not** permitted to wear fingernail varnish or style cosmetics during 'on-duty' hours, whether wearing military uniform or civilian clothing, or when representing the ADF wearing military uniform, sporting or civilian attire. Men **are not to** wear fingernail varnish or style cosmetics **at any time** whilst on Defence establishments.

2.28 French polished fingernail varnish is permitted to be worn; however, no other colours of fingernail varnish other than those in Figure 2-1 are permitted to be worn. Dual or multiple colours or symbols and patterns, that are superimposed upon the base colour of fingernail varnish is not permitted to be worn, except for the wearing of French polished fingernail varnish. Examples of unacceptable nail colours are, but not limited to: red, blue, yellow, green, purple, black and florescent.

2.29 Facial foundation cream make-up, that acts as a sun protection agent is to be applied conservatively and may be worn in the field or on operations. Fingernail varnish is not to be worn in the field or on operations.

Figure 2-1: Fingernail varnish-permissible shades



FINGERNAILS

2.30 Fingernails are to be kept clean and neatly trimmed at all times, and not to extend beyond the tip of the thumb/finger. Fingernails of women soldiers are to be kept clean and neatly trimmed, and are not to extend further than 5 mm beyond the tip of the thumb/finger.

HAIR—MEN

2.31 Head hair is to be:

- a. Neatly groomed at all times.
- b. Taper trimmed from bare skin with the back, sides and above the ears blending with the hairstyle. The taper at the back is to commence above and parallel to the top of the shirt collar when buttoned.
- c. Worn short enough so that when hair is groomed and headdress is removed, no hair touches the ears or collar or extends below the top of the eyebrows.
- d. Cut and groomed so that hair-length is not greater than 4 cm, decreasing from the top and blending with the taper trimmed sides and back. The hair on the top of the head must be neatly groomed and not bulky. The length of the

hair must not present a ragged, unkempt or extreme appearance and any form of length or bulk that detracts from a professional military appearance is prohibited.

- e. Styled in a manner which does not interfere with the proper wearing of any military headdress or protective equipment.
- f. Hair on the neck, below and to the sides of the taper, is to be kept trimmed/shaved.

2.32 Radical hairstyles, such as mohawk, faux mohawk, undercut, fade (medium, high, bald), quiff, pompadour, comb-over, slicked-back, spikey, stepped, layered foils, streaked, bleached, unnatural or extreme colours, combinations of colours or styles which have an uncombed appearance **are not** permitted. Razored lines into the scalp such as tramlines, patterns or shapes **are not** permitted. A clean shaven head, buzz-cut, crew-cut, tailored French crop or close cropped hair, ie number one cut are permissible.

2.33 Sideburns are to:

- a. extend no lower than the point where the ear lobe joins the face
- b. be squared off in a horizontal line at the bottom edge
- c. be evenly trimmed to blend with the hairstyle and is to be an even width, not exceeding 4 cm.

BEARDS

2.34 Beards required due to medical reasons are to be managed IAW [Army Standing Instruction \(Personnel\) Part 8 Chapter 3—The application of the Medical Employment Classification System and PULHEEMS Employment Standards in the Australian Army](#)⁹.

2.35 When worn, beards are to be kept neatly trimmed and tapered to blend with the hairstyle. The whisker length of the beard is to be IAW Table 2-2. No area of the face is to be shaved when a beard is worn. Beards are only to be worn IAW Table 2-2. Beards are only to be worn by males.

2.36 **Pioneer Sergeant Royal Australian Regiment.** When Lord De L'Isle VC, GCMG, GCVO Governor General of Australia, presented 4 RAR with Queens and Regimental Colours on 11 Apr 65, in Adelaide S.A., he "suggested" to the CO that the Pioneer Sergeant wear a beard. This tradition is linked to the use of black powder as a demolition charge and the beard was a protective measure for the Pioneer Sergeant to reduce the powder flash burns. The tradition was also a flow-on from Lord De L'Isle's Regiment, the Grenadiers Guards. The Beard is worn un-kept keeping with the Grenadier Guards. Following on from that time the Pioneer Sergeant 4 RAR was the only bearded member of the Australian Army, until the 2004 Regimental Council approved the Pioneer Sergeant of 2 RAR to also wear a

⁹ <https://objective/id:R26414260>

beard. Justification was based on the 22 year linkage of 4 RAR and 2 RAR. The beard is currently worn by the Senior Online Boat Platoon Sergeant as the custodian.

Table 2-2: Beards

| Serial | When worn | Length |
|--------|---|---|
| 1 | Posted to 2 RAR as the Pioneer SGT | IAW tradition |
| 2 | Medical restrictions not to shave | Whisker length is to be no greater than a number 2 comb |
| 3 | DGAPC grants permission to a member on religious or cultural grounds IAW para 2.38 and 2.37 | IAW religion/culture |
| 4 | Practitioners of the Sikh religion, refer to para 2.36 a | |
| 6 | A commander authorises a member to grow a beard for periods of mourning or religious/cultural festivities, refer to para 2.41 | |
| 7 | DGCHAP-A may approve Army's Religious Advisors (e.g. Hasidic Jews, Imam, Orthodox), refer to para 2.39 | |
| 8 | An operational level force commander authorises a member to grow a beard for operational deployments | Whisker length is to be no greater than a number 2 comb |
| 9 | A member is on authorised leave off barracks | N/A |

2.37 Permanent wearing of a beard. If for religious or cultural reasons, members are required to permanently wear a beard, approval is to be sought in writing from Director General Army People Capability (DGAPC) via RSM-Ceremonial (RSM-C). The following process is to be used for all requests to grow a beard permanently for religious or culture purposes:

- a. **Cultural.** Applications for approval are to be submitted through the member's chain of command with local Elder or local Indigenous Cultural Organisations recommendations and are to include endorsement by the Commanding Officer (Equivalent). The member must demonstrate that they follow the strict followings of their culture. The Commander is to ensure the validity of the request. The Army Indigenous Cultural Advisory Board (AICAB) will review the application prior to final submission to DGAPC via RSM-C. Members who have received written approval by a commander prior to 2020 may maintain their beard in accordance with the grooming standard.
 - (1) Minute from member to the Chain-of-Command (CoC) requesting to be granted approval to grow and wear a beard IAW the member's cultural requirements and information provided within the ADM.
 - (2) Member's Minute complete with CoC and local Elder or local Indigenous Cultural Organisation recommendations to be sent to the AICAB and for information to RSM-C.

- (3) AICAB is to forward the application to RSM-C with comments.
- (4) RSM-C drafts a Decision Brief for DGAPC for consideration.
- (5) DGAPC provides written advice to member, CoC and AICAB on the outcome of the determination.
- (6) RSM-C updates the Beard Register.

b. **Religious.** Applications for approval are to be submitted through the member's chain of command and are to include advice from the Faith Group Defence Religious Advisor and endorsement by the Commanding Officer (Equivalent). The member must demonstrate that they follow the strict followings of their religion. The Commander is to ensure the validity of the request. Members who have received written approval by a commander prior 2020 may maintain their beard within accordance of the grooming standard.

- (1) Minute from member to the Chain-of-Command (CoC) requesting to be granted approval to grow and wear a beard IAW the member's known religious belief and information provided within the ADM.
- (2) Member's Minute complete with CoC and Chaplains' recommendations sent to RSM-C.
- (3) RSM-C is to forward the application to DGCHAP-A for comments from the Religious Advisory Committee to the Services (RACS); DGCHAP-A returns the application to RSM-C with comments.
- (4) RSM-C drafts a Decision Brief for DGAPC for consideration.
- (5) DGAPC provides written advice to member, CoC and DGCHAP-A on the outcome of the determination.
- (6) RSM-C updates the Beard Register.

2.38 Approvals for members enlisting through initial recruitment are to be processed by Army People Capability Branch for DGAPC approval through RSM-C.

2.39 No member is to grow a beard until formal approval is advised by DGAPC. If a member has been granted approval to wear a beard for religious or cultural reasons and then shaves it for personal reasons they must reapply seeking approval to wear a beard permanently.

2.40 DGCHAP-A may approve Religious Advisors (such as a Rabbi of Hassidic or Ultra-Orthodox faith, or an Imam of the Islamic faith) to wear a beard. DGCHAP-A is to undertake this in writing and provide a copy to DGAPC, via RSM-C, to ensure a record is maintained.

2.41 When a potential hazard clearly exists, and to ensure operational effectiveness and Workplace Health and Safety considerations are not jeopardised, when the member is required to wear occupational and operational equipment (eg. gas masks, oxygen masks combat/vehicle/flying helmets, hard hats, scuba masks,

body armour etc) during military operations, operational training or exercises, the member and the unit CO are to ensure that the beard is modified to the degree necessary for wearing the required equipment. If a member is directed to shave their beard to manage potentially hazardous situations, they do not need to reapply to re-grow the beard.

2.42 Short-term wearing of a beard. Commanders may authorise the wearing of a beard for short term religious or cultural reasons, such as a period of mourning (eg. Greek Orthodox, Judaism) or periods of religious or cultural festivities (eg. Passover, Ramadan) on written application by the member. The approval period is not to exceed a total of 60 days. This includes 10 days to grow the beard and 10 days after the event, following which the member is to be clean shaven. Approval is to be provided to the member in writing by the Commanding Officer stipulating the commencement date and completion date. Members are not to grow a beard until formal approval is advised by the Commander in writing.

2.43 Short Term may also be for those members who are SERCAT5 and of a State Police Force requiring a beard in the line of their primary duties undercover. Written is requested in writing by the members civil commander with and end date.

MOUSTACHES

2.44 Moustaches are to be neatly trimmed and are not to exceed 2cm in length. Handlebar and similar styles are not permitted unless authorised for specific charitable activities. Except when authorised for charitable activities, no part of the moustache is to extend below the top lip or past the corners of the mouth. Commanders and COs may authorise in writing, unit members to grow moustaches in support of a charitable activities. Only in this instance is a handlebar and similar style moustache permitted. When authorising the growth of moustaches for charitable activities, a commander or CO must comply with the following caveats:

- a. the moustache is not to extend beyond the region of the mouth, chin and top lip
- b. the moustache is not to extend to other parts of the face
- c. the moustache is not to extend to join the side burns
- d. the moustache is not to form a goatee style beard or similar styles of beards
- e. members are not to be involved in any representational ceremonial duties
- f. it must be a nationally recognised charity event, eg Blue September, Movember, Bandana Day etc
- g. outline the specific event and a fixed period of time that specifies the start and end date
- h. there must be no damage to Army's reputation as a result of the event.

SHAVING

2.45 Men are to be clean shaven daily when on duty, and:

ADM

2-16

- a. on a Defence establishment, prior to the designated first parade
- b. attending any administration parade, medical appointment, sick parade, for meals in Messes on Barracks or at a Defence establishment IAW the Senior ADF Officers instructions
- c. representing Defence at sponsored gatherings, sporting activities and official functions regardless of whether in uniform or not
- d. travelling from one place of duty to another when it is an official move, eg to and from course on government funded travel or official visits
- e. participating in any Defence representative activities domestically and internationally
- f. facial hair that has rapidly grown during the day and stubble growth which is visible prior to attending an evening formal dinner, eg Regimental Dining In/Out, Candle Light Dinner or Association Dinner
- g. when off duty on a Defence establishment and not in uniform, men are permitted **not to shave** during periods of leave, stand down or weekends

HAIR—WOMEN

2.46 Hair is to be:

- a. neatly groomed at all times
- b. groomed so that it does not fall below the eyebrows or extend below the lower edge of the buttoned shirt collar or the top of the collar of the General Duty Dress - Female
- c. styled so that hair does not interfere with the proper wearing of any military headdress or protective equipment.

Hair colouring

2.47 Hair colouring is not to be extreme. Unnatural or extreme colours are not permitted. A natural appearance is to be maintained.

Radical hairstyles

2.48 Radical hairstyles, such as mohawk, faux mohawk, undercut, fade (medium, high, bald), quiff, pompadour, slicked-back, spikey, stepped, layered foils, streaked, bleached, unnatural or extreme colours, combinations of colours or styles which have an uncombed appearance **are not** permitted. Razored lines into the scalp such as tramlines, patterns or shapes **are not** permitted. A clean shaven head, buzz-cut, crew-cut, close cropped hair, ie number one cut are permissible.

2.49 Hair accoutrements are to be of a similar colour to the hair. Acceptable accoutrements are hair combs, clips, nets, elastic bands, hair pins and bun pieces. Head bands are acceptable for PT.

ADM

2-17

2.50 Long hair may be worn as follows:

- a. Tied back in a bun, which is secured to the head, ie a French roll or a bun and is not to extend below the top of the collar **Figure 2-2, Figure 2-3, Figure 2-4.**
- b. A single or double braid, plait or ponytail may be worn only with Dress Orders 4, 5 and 9 **in the barracks, when on field exercises, for PT activities** or on operations, IAW **Figure 2-5, Figure 2-6 and Figure 2-7.** Commanders at all levels are responsible to direct that hair is to be worn up and secured to the head, **Figure 2-3,** if the length of the plait, braid or ponytail poses a safety concern or workplace risk or risk of injury. When hair is worn in a braid, plait or ponytail and exceeds 15cm from the bottom of the collar of the AMCU shirt, it is to be folded and tied to be no longer than 15cm from the bottom of the collar.

2.51 Box Braids and Cornrows, are a type of hair-braiding style **are only to be worn by females with Afro-textured hair, or kinky hair.** This texture of hair is often found in those of African diaspora and Pacific Island origin. Medium and long hair may be styled with braids and cornrows. Each braid, cornrow, will be of uniform dimension, have a diameter no greater than a 12mm, and present a neat, professional, and well-groomed appearance. Each must have the same approximate size of spacing between the braids and cornrows. Each hairstyle may be worn against the scalp or loose (free-hanging). When worn loose, such hairstyles must be worn per medium hair length guidelines or secured to the head in the same manner as described for medium or long length hair styles. Ends must be secured inconspicuously. When multiple loose braids are worn, they must encompass the whole head. When braids and cornrows are not worn loosely and instead worn close to the scalp, they must stop at one consistent location of the head and must follow the natural direction of the hair when worn back, which is either in general straight lines following the shape of the head or flowing with the natural direction of the hair when worn back with one primary part in the hair. Hairstyles may not be styled with designs, sharply curved lines, or zigzag lines. Only one distinctive style may be worn at one time. Braids and cornrows that distinctly protrude (up or out) from the head are not authorized. The bulk of the hair may not be such that it does not interfere with the proper wearing of any military headdress or protective equipment **Figure 2-10.**

- a. For PT activities a ponytail is permitted; however, for battle PT the ponytail is to be tied off at the bottom.

Figure 2-2: a French Roll



Figure 2-3: a Bun



Figure 2-4: Single braid with bun



Figure 2-5: Ponytail with plait



Figure 2-6: A Single Braid



Figure 2-7: Ponytail



Figure 2-8: Bun



Figure 2-9: A ponytail with a plait field/PT



Figure 2-10: A ponytail PT



WIGS

2.52 The wearing of a wig or hairpiece by personnel when wearing uniform is not permitted, except by Religious Advisers or to cover natural baldness or physical disfiguration caused by accident or medical procedure. When worn, a wig or hairpiece is to conform to the standard criteria for hair.

JEWELLERY

2.53 Jewellery is not to be worn by personnel in uniform with the exception of wrist watches, medic alert bracelets, soldier Killed In Action (KIA) memorial bracelets, earrings, engagement, wedding, eternity and signet rings. A signet ring is defined as one which has a private seal, crest, initials or signature set in the face. On a ceremonial parade, identification or medical alert bracelets are not to be visible.

2.54 The soldier KIA memorial bracelet, in Figure 2-2 is to be made of black anodised light alloy metal. The bracelet is to be made in a 'horseshoe' pattern so that a 2 cm space is designed when fitted on the inside of the members' wrist. The text engraving/etching is to be silver, Times New Roman, font size 12. An Australian National Flag may be engraved/etched on the left side of the bracelet. An operational emblem may be engraved/etched on the right side of the bracelet. Other motifs, emblems, badges, Corps badges or quotes are not permitted to be engraved/etched on the bracelet. Only **one** bracelet is to be worn on either the left wrist or the non-watch wearing wrist. The bracelet is **not** to be worn with Aerobic PT, Combat or Battle PT, and sports dress or on ceremonial parades when wearing ceremonial orders of dress. The soldier KIA memorial bracelet is not to be purchased at Commonwealth expense.

Figure 2-11: Soldier Killed in Action memorial bracelet



RINGS

2.55 Engagement, wedding and/or eternity rings are to be worn together only on the ring finger. Only a single ring of another type is permitted and is to be worn on the middle, ring or little finger of either hand. Where there is a risk of injury, rings are to be removed or taped whilst conducting group or individual PT sessions, in the field or on operations. Signet rings are not to be worn on ceremonial parades when wearing ceremonial orders of dress.

EARRINGS

2.56 Piercing of the ears are not to cause any abnormal disfigurement or deformity of the ears. Only ear piercing that allows the wearing of earrings is allowed. Ear spacers that stretch the ear lobes or other parts of the ears which form abnormal size holes are not to be worn under any circumstances when either on or off duty, on Defence establishments and/or in the public domain.

2.57 Women wearing the Australian Army uniform, may wear a gold or silver single sleeper not greater than 10 mm in diameter, in the lobe of each ear, or a single stud type decorative style gem stone (diamond only) not greater than 5 mm in diameter in the lobe of each ear, or a single stud type earring of plain gold or silver with an orb not greater than 5 mm in diameter, in the lobe of each ear. When wearing mess dress orders of dress, members may wear a single stud decorative style pearl or gem stone not greater than 5 mm in diameter. No other type of earring is to be worn. Women when off duty, on Defence establishments, may wear one earring in the lobe of each ear.

2.58 Men wearing the Australian Army uniform **are not** permitted to wear ear jewellery of any type during 'on-duty' hours, whether wearing military uniform or civilian clothing, or when representing the ADF wearing military uniform, sporting or civilian attire. Members wearing civilian attire carrying military equipment, luggage and/or clothing are deemed to be representing the ADF. Men **are not to** wear ear jewellery **at any time** whilst on Defence establishments.

WATCHES

2.59 Watches or watch bands are not to be worn when they may create a safety hazard. Brightly coloured watches or watch bands are not permitted. Pocket watches with visible chains are not to be worn with the Australian Army uniform. On a ceremonial parade a watch is not to be worn by any member, except the senior

soldier controlling the sequence of a parade; normally the RSM or CSM (E) who may wear an inconspicuous timepiece.

BODY EMBELLISHMENTS

2.60 **Body Piercing.** Body piercing is generally permitted in the Australian Army unless the piercing does not align with the values of the Australian Defence Force or is on the face. Body piercing **is** also **not** permitted when there is a risk to the safety of the individual or others or they cause any unsightly or abnormal disfigurement or deformity to **any** part of the body. Members wearing the Australian Army uniform **are not** permitted to wear **any** form of body piercing, beading or teeth jewellery adornment whilst on duty or whilst on Defence establishments, when off duty with the exception of females IAW paragraphs 2.49 and 2.50 of this chapter.

2.61 **Body Embellishments.** Body embellishments include tattoos, branding and body modification.

2.62 **Tattoos and Brands.** Tattoos are defined as a picture, design, or marking made on the skin by staining it with an indelible dye, or by any other method, including pictures, designs, or markings only detectible or visible under certain conditions (such as ultraviolet or invisible ink tattoos).

2.63 **Prohibited Tattoos and Brands.** Tattoos, anywhere on the body, are deemed prohibited if they are:

- a. **Extremist.** Affiliated with, depicting or symbolising extremist philosophies, organisations or activities (eg. Organisations or activities that advocate racial, gender or ethnic hatred or intolerance; advocate, create or engage in discrimination based on race, colour, gender, ethnicity, religion or origin; or advocate violence or other unlawful activities).
- b. **Sexist.** Images, symbols or words that degrades or demeans a person based on gender or gender identity.
- c. **Racist.** Images, symbols or words that degrades or demeans a person based on race, ethnicity or origin.
- d. **Drug use.** Advocates illegal drug use.
- e. **Intimidating.** Is likely to be perceived as unnecessarily intimidating by a reasonable person.
- f. **Indecent.** Likely to be regarded as offensive by a reasonable person.
- g. **Indecent.** Undermines the values and dignity of the Australian Army or is likely to be regarded as offensive by a reasonable person.

2.64 **Head, neck and facial tattoos.** The following applies to head and facial tattoos:

- a. Tattoos on the face, as may be visible in a passport photo, including the eyes are prohibited.

- b. Tattoos on the front portion of the neck as may be visible in a passport photo when wearing a T-shirt are prohibited.
- c. Tattoos for cosmetic purposes are permitted.
- d. Waivers may be considered by DGAPC for any reason including religious or cultural reasons.

2.65 **Cosmetic Tattoos.** Women wearing the Australian Army uniform are permitted to have tattooed eyebrow forms, excluding eyeliner, providing it follows the natural arch line of eyebrows and is of a natural colour that matches the colour of the hair. Lip tattooing can be used to enhance the outline of the lips providing it does not look unnatural, ie not outlined in black, not a non-flesh colour and does not change the natural shape of the lips. If for religious reasons, members are required to obtain tattoos on those areas prohibited, approval is first to be sought in writing from DGAPC.

2.66 Men wearing the Australian Army uniform suffering male pattern baldness are permitted to have the procedure Scalp Micropigmentation. Permission is to be first sought in writing through the unit CO. The members CO is to respond in writing outlining that permission is granted and that the member must take personnel leave to undertake the process and personnel leave during the recovery period.

2.67 If there is any doubt, prior to having any tattooing in those areas deemed prohibited, a ruling on eligibility **is to be** sought through DGAPC. If given the approval of the visible tattoo, it is to be recorded on the members personnel file.

2.68 **Body modification.** Body modification is defined as the intentional radical alteration/mutilation of the body, head, face, or skin for the purpose of, or resulting in, a change in appearance. Body modification includes body piercing and attachments to body piercing, the insertion of objects or implants to produce a pattern or abnormal shape(s). The body modifications listed below detract from a professional military image and/or pose a WHS risk, so are not permitted:

- a. **Stretching.** Stretching of earlobes, lips, or other body parts is the means by which one can gradually enlarge a pierced hole using pieces of jewellery ranging from rings to plugs.
- b. **Subdermal implantation.** A subdermal implantation is a body modification that is placed underneath the skin, therefore, allowing the body to heal over the implant and creating a raised design. Also known as horns or beading.
- c. **Transdermal implantation.** Transdermal implantations are where an object is placed partially below and partially above the skin, also known as anchors.
- d. **Tongue bifurcation.** Tongue splitting or forking is a type of body modification in which the tongue is cut centrally from its tip to as far back as the underside base, forking the end.
- e. **Sharpening or shaping of teeth.** Modification of teeth into unnatural shapes such as points.

- f. **Ear cropping/shaping.** The deliberate cropping or shaping of the ears (such as elfing) to give an unnatural appearance.

2.69 **Prohibited body modification on enlistment or appointment.** Candidates for Army enlistment or appointment are to be advised that they may not be deemed suitable for entry to the Army unless they obtain professional help to have the modification removed/corrected at their own expense.

2.70 **Other body modifications.** SERCAT 6 and 7 members are to inform the ADF Health Service of any intended body modifications (including cosmetic procedures), as detailed at *Defence Health Manual*, Volume 1, Part 4 Chapter 1. Members who engage in body ornamentation and/or modification without the knowledge of the Defence Health Service, may be subject to disciplinary and/or administrative action, compromise compensation entitlements as well as being required to take corrective action at their own expense.

2.71 **Safety.** The procedures involved with body ornamentation and modification may present a serious medical risk when not conducted under stringent hygiene conditions and may also result in medical or dental complications at later stages. Items of body jewellery or ornamentation may also represent a WHS risk. All Army members are to ensure they are fully conversant with the risks of body ornamentation and modification procedures prior to undergoing them.

2.72 If a member obtains a tattoo, branding or modification in an area deemed prohibited, without first going through the approval process and gaining approval, they will be required to remove the tattoo, branding or correct the modification. The removal or correction will be at the member's own expense, if the member refuses to have the removal or modification completed they are to be processed administratively with a Notice to show cause (NTSC) for termination IAW Defence policy.

2.73 **Uniform Policy.** Standards for the wearing the Australian Army uniform are to be adhered to at all times. Members with visible tattoos or piercings may be required to remove those piercings and cover tattoos where reasonable.

SIKH RELIGION

2.74 A member of the Australian Army; whether male or female, who is an adherent of the Sikh religion (Keshadharis) is to wear the Australian Army uniform and is to adhere to all dress policy, IAW the Army Dress Manual and/or related instructions, except for the following:

- a. **Hair.** The hair and beard may remain uncut, provided that the operational effectiveness and Workplace Health and Safety considerations are not jeopardised, when the member is required to wear occupational and operational equipment, such as gas masks, oxygen masks combat/vehicle/flying helmets, hard hats, scuba masks, body armour etc, during combat operations, operational training or exercises, when serving with peacekeeping or multinational contingents. When a hazard clearly exists, the member and the unit CO are to ensure that the hair and/or beard are to be modified to the degree necessary for wearing the required equipment. When participating in ceremonial parades and representing the

Australian Army, the hair is to be tied in such a manner so the beret or the Ceremonial Hat KFF, and all items of ceremonial orders of dress can be worn.

- b. **Religious symbols.** In addition to uncut hair, five other symbolic requirements of the Sikh religion, in paragraph 2.67 are authorised to be worn with all orders of dress, by both male and female members. Should a conflict arise between the wearing of safety or operational clothing and equipment, and these religious symbols, the manner and location of wearing these symbols are to be adjusted or they are to be removed. Unit COs are authorised to order the manner of this adjustment or removal as necessary, in order to meet valid safety and operational requirements. Such orders are to take into account the sensitivity of the issue. When participating in ceremonial parades and representing the Australian Army, these symbols are to be worn in such a manner so the beret or the Ceremonial Hat KFF, and all items of ceremonial orders of dress can be worn.
- c. **Turban.** A turban (patka) **may** be worn with all orders of dress when representing the Australian Army, by male and female members of the Sikh religion, IAW paragraph 2.67(a). Adherents of the Sikh religion are to when deemed essential, cover their head with a turban or other customary clothing item over which they are to wear headdress, including combat helmets and other items of military equipment, as ordered by the unit CO. The colour of the turban, worn with all orders of dress is to be black or tan to mid brown in colour. The material used is to be the standard currently worn by a Sikh religious member. The provision of turbans for Sikh members is a member's responsibility, IAW [Chapter 3](#). When participating in ceremonial parades and representing the Australian Army, the beret or the Ceremonial Hat KFF is to be worn with all items of ceremonial orders of dress if the turban is **not** worn. The turban is to be **only** embellished with a Corps or Regimental hat badge. The hat badge is to be worn at the front of the turban, central to the head, 1 cm above the turban overlap, IAW Figure 2-3. When deployed in the field, on operations or participating in field related activities in the barracks environment, the patka may be worn under the hat utility in lieu of the turban and is **not** to be embellished with a hat badge, any other badges or patches. If the turban is worn during these occasions, it is also not to be embellished with a hat badge, any other badges or patches.

Figure 2-12: Positioning of the hat badge on a turban

2.75 A turban worn by a Sikh religious member, is not to be removed while wearing uniform, except in the circumstances in paragraph 2.67. In addition, when reporting on-duty and wearing civilian clothing, the civilian turban is not to be removed. Hat badges or patches are not to be worn on a civilian turban. The turban is not to be removed in the following circumstances:

- a. on parade, when other members are required to remove their headdress
- b. by a member of a bearer party at a military funeral
- c. during the administration of the Oath of Allegiance by an attesting officer
- d. when paraded as the accused before a summary authority
- e. when paraded as the accused before a Defence Force Magistrate or Court Martial
- f. when entering a consecrated building
- g. when entering a mess or dining room
- h. at a formal or informal function, when the removal of headdress is considered appropriate.

Five symbolic requirements

2.76 Adherents of the Sikh religion are permitted to observe the following five symbolic requirements, except during the circumstances in paragraph 2.67. They are:

- a. **Kesh.** Kesh (Hair) is to leave hair on the head, face and body uncut.
- b. **Kanga.** Kanga (Comb) is to wear a comb.

- c. **Kara.** Kara is to wear an iron bangle (bracelet).
- d. **Kacha.** Kacha is to wear under-drawers of a specific design.
- e. **Kirpan.** Kirpan is to wear a symbolic dagger with an overall length, including handle and sheath not exceeding 23 cm.

Method of wearing Sikh religious accoutrements

2.77 The method of wearing Sikh religious accoutrements is as follows:

- a. **Turban.** The turban is to be worn at a low Sikh conventional manner, with the final winding to be over the left of the forehead. If ribbons are to be worn, the lower edge is to be positioned 2 cm from the lowest edge of the turban at the sides of the head, and crossed over the left at the centre of the forehead. The ribbons are to be secured on the turban by tucking the ends into the folds at the front and rear. The cloth is to be long enough to provide five overlapping layers to the left of the turban.
- b. **Patka.** A traditional cloth head-covering, may be worn when a turban is not suitable, such as under combat, flying or diving helmets, or during sports and/or physical training activity.
- c. **Kesh (Hair).** Male members are to wear their hair, tied in a knot at the crown of the head and secure the hair of the beard under the chin presenting a close-to-face, groomed appearance. Female members who elect not to wear a turban or patka are to wear their hair styled in a bun at the rear of the head to facilitate the proper wearing of standard headdress, IAW paragraph 2.41–2.45.
- d. **Kanga (Comb).** The Kanga is to be worn and is to be concealed in the hair.
- e. **Kara (Bangle or Bracelet).** The Kara is to be worn on the right wrist.
- f. **Kirpan (Dagger).** The Kirpan is to remain sheathed, except for religious occasions and cleaning purposes. The sheathed Kirpan, worn under the outer shirt or jacket, is to be supported by a black cloth sling, slung from the right shoulder to the left side of the body. Should the Kirpan interfere with the wearing of uniform accoutrements or equipment, it may be slung from the left shoulder and worn on the right side.

Covering of arms and legs

2.78 Sikh religious members may be permitted to wear trousers when other personnel wear shorts or skirts. Where it is practical and appropriate, swimwear that is purchased at the member's expense, that is in-keeping with Sikh requirements for modesty, may be worn.

Annex:

2A [Special Operations Command](#)

SPECIAL OPERATIONS COMMAND

1. Members posted to Special Operations Command (SOCOMD) units are entitled to wear the following embellishments and headdress associated with their respective units.
 - a. **Lanyard.** With the exception of the senior leadership group, all SOCOMD personnel are to wear the garter blue lanyard for the duration of their service/tenure in SOCOMD.
 - b. **Unit Colour Patch.** For those occasions of protocol where Hat Khaki Fur Felt (KFF) is to be worn, members are to wear the Unit Colour Patch associated with their respective unit regardless of qualification.
 - c. **Unit Shoulder Patch.** Members posted to SOCOMD units are to wear the Unit Shoulder Patch associated with their respective unit regardless of qualification.
 - d. **Parachute Qualification Badge.** Parachutist Qualification Badge or 'Wings' in [Annex 4G](#) is a military badge awarded by the armies of most countries to soldiers who have received the appropriate training and accomplished the required number of jumps/descents, either as a Static Line paratrooper or as a Military Free Fall operator. Members of SOCOMD are to wear the parachute badge of their Special Forces (SF) qualification. Non-SF qualified SOCOMD personnel are to wear the Basic Parachutist Badge or unit specific parachutist badge of their last parachute unit. Personnel entitled to wear the Special Air Service Regiment (SASR) or Commando (Cdo) Parachutist Badge may continue to do so for the duration of their service. Those personnel with advanced parachute instructor qualifications are to wear the associated insignia of their qualification, in accordance with (IAW) [Annex 4G](#).
 - e. **Beret.** Members of SOCOMD are to wear the beret of their Special Forces (SF) qualification. Non-SF qualified SOCOMD personnel are to wear the Army Dark Blue Beret with the Regimental hat badge of the unit they are posted to. Non-SF qualified SOCOMD personnel posted to the SFTG or SOCAUST HQ are to wear the beret of their Corp and badge if allocated or those of the RAR are to wear the Rifle Green beret with RAR badge. Personnel entitled to wear the Special Air Service Regiment (SASR) Fawn or Commando (Cdo) Sherwood Green beret may continue to do so for the duration of their service unless they post to a unit or formation that wears a distinctive hat badge or beret.
2. To ensure distinct clarity, personnel posted to SOCOMD units are defined into one of the following categories and are to wear the appropriate headdress and embellishments.
 - a. **Special Forces qualified personnel.** Personnel who have successfully completed the qualification requirements for the respective unit Employment Category Number (ECN) are deemed qualified for that particular unit–ECN

353 for SASR and ECN 079 for 1 Cdo Regiment (Regt) and 2 Cdo Regt respectively.

- b. **Special Forces qualified support staff personnel.** Personnel who are non-Royal Australian Corps of Infantry, who have successfully completed the SASR or Cdo selection and reinforcement cycle, as required by the Defence Force Remuneration Tribunal, to be recognised as beret qualified in either ECN 353 or ECN 079, but remain aligned to their parent Corps and trade. Such personnel are entitled to wear the embellishments of a qualified member.
 - c. **Non-SF qualified personnel.** Personnel who have either not attempted, or have not successfully completed the qualification requirements for either ECN 353 or ECN 079.
 - d. **Intra-unit posting of beret qualified personnel.** Whilst remaining in SOCOMD and posted between SOCOMD units, SF qualified personnel are to wear the Special Operations (SO) beret and embellishment of their qualification but adopt the specific regiment/unit badges.
3. Members posted to SASR are to wear the following:
- a. **Special Forces qualified personnel.** Fawn beret (or beret of their qualification) or Hat KFF, SASR badges, 'AUSTRALIA'/Regiment shoulder titles and SASR Parachutist Badge (or Parachutist of their qualification). The hat badge is surmounted with a dark blue cloth shield background on the beret and Hat KFF. The garter blue lanyard is to be worn on the left shoulder.
 - b. **Special Forces qualified support staff personnel.** When such members have completed the full suite of reinforcement courses, they are to wear the Fawn beret (or beret of their qualification) or Hat KFF, SASR badges, 'AUSTRALIA'/Regiment shoulder titles and SASR Parachutist Badge (or Parachutist of their qualification). The hat badge is surmounted with a dark blue cloth shield background on the beret and Hat KFF. The garter blue lanyard is to be worn on the left shoulder.
 - c. **Non-Special Forces qualified personnel.** Hat KFF or Army/Service blue beret, SASR badges and 'AUSTRALIA'/Corps shoulder titles. If parachute qualified, either the Basic Parachutist Badge or 3 Royal Australian Regiment (RAR) Parachutist Badge is to be worn. The garter blue lanyard is to be worn on the left shoulder.
4. Members posted to 1 Cdo Regt are to wear the following:
- a. **Special Forces qualified personnel.** Sherwood Green beret (or beret of their qualification) or Hat KFF, 1 Cdo Regt badges, 'AUSTRALIA'/Regiment shoulder titles and Cdo Parachutist Badge (or Parachutist of their qualification). The hat badge is surmounted with a black cloth shield background on the beret and Hat KFF. The garter blue lanyard is to be worn on the left shoulder.
 - b. **Special Forces qualified support staff personnel.** When such members have completed the full suite of reinforcement courses, they are to wear the

Sherwood Green beret (or beret of their qualification) or Hat KFF, 1 Cdo Regt badges, 'AUSTRALIA'/Regiment shoulder titles and Cdo Parachutist Badge (or Parachutist of their qualification). The hat badge is worn with a black cloth shield background on the beret and Hat KFF. The garter blue lanyard is to be worn on the left shoulder.

- c. **Non-Special Forces qualified personnel.** Hat KFF or Army/Service blue beret, 1 Cdo Regt badges and 'AUSTRALIA'/Corps shoulder titles. If parachute qualified, either the Basic Parachutist Badge or 3 RAR Parachutist Badge is to be worn. The garter blue lanyard is to be worn on the left shoulder.
5. Members posted to 2 Cdo Regt are to wear the following:
- a. **Special Forces qualified personnel.** Sherwood Green beret (or beret of their qualification) or Hat KFF, 2 Cdo Regt badges, 'AUSTRALIA'/Regiment shoulder titles and Cdo Parachutist Badge (or Parachutist of their qualification). The hat badge is surmounted with a black cloth shield background on the beret and Hat KFF. The garter blue lanyard is to be worn on the left shoulder.
 - b. **Special Forces qualified support staff personnel.** When such members have completed the full suite of reinforcement courses, they are to wear the Sherwood Green beret (or beret of their qualification) or Hat KFF, 2 Cdo Regt badges, 'AUSTRALIA'/Regiment shoulder titles and Cdo Parachutist Badge (or Parachutist of their qualification). The hat badge is worn with a black cloth shield background on the beret and Hat KFF. The garter blue lanyard is to be worn on the left shoulder.
 - c. **Non-Special Forces qualified personnel.** Hat KFF or Army/Service blue beret, 2 Cdo Regt badges and 'AUSTRALIA'/Corps shoulder titles. If parachute qualified, either the Basic Parachutist Wings or 3 RAR Parachutist Badge is to be worn. The garter blue lanyard is to be worn on the left shoulder.
6. Members posted to Special Forces Training Centre are to wear the following:
- a. **Special Forces qualified personnel.** Beret or Hat KFF, badges, 'AUSTRALIA'/Regiment shoulder titles and all other embellishments of their qualification, IAW paragraph 2-5 of this annex. The garter blue lanyard is to be worn on the right shoulder.
 - b. **Special Forces qualified support staff personnel.** When such members have completed the full suite of reinforcement courses, they are to wear the beret or Hat KFF, badges, 'AUSTRALIA'/Regiment shoulder titles and all other embellishments of their qualification, IAW paragraph 2-5 of this annex. The garter blue lanyard is to be worn on the right shoulder.
 - c. **Non-Special Forces qualified personnel.** Hat KFF or Army/Service blue beret, parent Corps badges and 'AUSTRALIA'/Corps shoulder titles. If parachute qualified, either the Basic Parachutist Badge or 3 RAR Parachutist

Badge is to be worn. The garter blue lanyard is to be worn on the right shoulder.

7. Members posted to Special Operations Logistic Squadron (SOLS) are to wear the following:
 - a. **Special Forces qualified personnel.** Beret or Hat KFF, SOLS hat badge, collar badges and 'AUSTRALIA'/Regiment shoulder titles and all other embellishments of their qualification, IAW paragraph 2-5 of this annex. The garter blue lanyard is to be worn on the right shoulder.
 - b. **Non-Special Forces qualified personnel.** Hat KFF or Army/Service blue beret, SOLS hat badge, parent Corps collar badges and 'AUSTRALIA'/Corps shoulder titles. If parachute qualified, either the Basic Parachutist Badge or 3 RAR Parachutist Badge is to be worn. The garter blue lanyard is to be worn on the right shoulder.
8. Members posted to Special Operations Engineer Regiment (SOER) are to wear the following:
 - a. **Special Forces qualified personnel.** Beret or Hat KFF, SOER hat badge, collar badges and 'AUSTRALIA'/Regiment shoulder titles and all other embellishments of their qualification, IAW paragraph 2-5 of this annex. The garter blue lanyard is to be worn on the right shoulder.
 - b. **Non-Special Forces qualified personnel.** Hat KFF or Army/Service blue beret, SOER hat badge, parent Corps collar badges and 'AUSTRALIA'/Corps shoulder titles. If parachute qualified, either the Basic Parachutist Badge or 3 RAR Parachutist Badge is to be worn. The garter blue lanyard is to be worn on the right shoulder.
9. Members posted to Parachute Training School are to wear the dull cherry beret or Hat KFF, badges and 'AUSTRALIA'/Corps/Regiment shoulder titles and all other embellishments of their parent Corps/Regiment qualification, IAW paragraph 2-5 of this annex. The garter blue lanyard is to be worn on the right shoulder.
10. Members posted to Special Operations Headquarters (SOHQ) are to wear the following:
 - a. **Special Forces qualified personnel.** Beret or Hat KFF, badges with the appropriate cloth backing, AUSTRALIA'/Regiment shoulder titles and other embellishments of their parent Regiment qualification, IAW paragraph 2-5 of this annex. The garter blue lanyard is to be worn on the right shoulder.
 - b. **Non-Special Forces qualified personnel.** Hat KFF or Army/Service blue beret, parent Corps badges and 'AUSTRALIA'/Corps/Regiment shoulder titles. If parachute qualified, either the Basic Parachutist Badge or 3 RAR Parachutist Badge (**if entitled**) is to be worn. The garter blue lanyard is to be worn on the right shoulder.

11. In addition to the above requirements; Parachute Jump Master, Parachute Jump Instructor and Free Fall Instructor personnel are to wear the Brevet appropriate to their qualification.
12. All personnel posted to SOCOMD units are to wear Australian Army buttons.
13. **When posted from a SOCOMD unit:**
 - a. **Special Forces qualified personnel.** May continue to wear the embellishments of their SF qualification for the remainder of their service subject to the following circumstances:
 - (1) Personnel posted from SOCOMD to a unit which has specific Corps/regiment/unit embellishments are to be worn for the term of their posting, IAW [Chapter 3](#).
 - (2) Qualified personnel posting from SOER to a non-RAE unit may continue to wear SOER Hat badge with RAE shoulder title and RAE lanyard for the during of that posting and then to wear RAE hat badge and embellishments after two years if they have not returned to SOCOMD after that period of time. Members posting to SME may continue to wear the SOER Hat badge with RAE shoulder title and RAE lanyard unless hold a key appointment such as RSM/OC those personnel are to revert to Corps embellishments.
 - (3) Personnel deemed unsuitable for further service in a SF unit are to remove the headdress and embellishments of their qualification, and adopt the Corps /regiment/unit embellishments of their recognised qualification including collar badges, lanyard, 'AUSTRALIA'/Corps/Regiment shoulder titles and Basic Parachute Badge. Personnel subject to this category will be advised in writing by SOHQ. The members' Career Advisor will also be advised for endorsement, record keeping and entered into PMKeyS.
 - b. **Non-Special Forces qualified personnel.** Personnel are to remove all SO dress embellishments and adopt those embellishments appropriate to their new Corps/regiment/unit.
 - c. **Special Forces qualified support staff personnel.** Personnel may remain in SO unit hat badge with corps shoulder title and lanyard for a single two year posting cycle to a non – corps posting such as a training establishment 1 RTB/RMC-D or formation Headquarters such as AHQ/BDEHQ. SO dress embellishments are to be removed if the member is posted back into a corps or trade and are to adopt those embellishments appropriate to Corps/regiment/unit. Members may continue to wear authorised qualified Basic Parachute Badge.

CHAPTER 3

INTERPRETATION OF THE ARMY DRESS MANUAL

The Army Dress Manual is to be interpreted as positive instructions, meaning if a situation is **not** specified in the Army Dress Manual, it is therefore **prohibited**; however, elements of this manual provide specific direction to the reader.

ITEMS OF DRESS, EMBELLISHMENTS AND ACCOUTREMENTS**AIGUILLETTE**

3.1 The aiguillette is worn by officers to distinguish special and senior appointments. It is worn with ceremonial, general duty and mess dress orders of dress. An officer who is entitled to wear the aiguillette on the left shoulder is also to wear the respective Corps lanyard on the right shoulder should that particular officer be entitled to wear a lanyard. An officer who is entitled to wear the aiguillette on the right shoulder is not to wear any lanyard on either the right or left shoulder. An officer no longer holding such an appointment is not to wear the aiguillette.

3.2 There are two types of aiguillette:

- a. No 1 – made of 6 mm gold wire cord with gold metal tags at the ends of the plaits.
- b. No 2 – made of 6 mm gold and red orris basketcord, with plait and cord loop in front and back, the plaits ending in plain cords with gold metal tags. There is a separate item for either shoulder.

3.3 The type of aiguillette worn, when they are worn and on which shoulder they are worn are in Table 3–1.

Table 3-1: Members entitled to wear the aiguillette

| Serial | Aiguillette type | Worn by | When worn | Shoulder |
|--------|------------------|---|---|----------|
| 1 | 1 | Officers holding the Office of Governor-General or Governor of a State within the Commonwealth of Australia | When wearing military uniform | Right |
| 2 | 1 | Officers holding personal appointment to the Sovereign: a. ADC General b. ADC including honorary appointments c. Honorary Physician d. Honorary Surgeon e. Honorary Dental Surgeon f. Honorary Nursing Sister g. Equerries h. Extra Equerries | When acting in the capacity of their appointment in attendance to the Sovereign | Right |

| Serial | Aiguillette type | Worn by | When worn | Shoulder |
|---------------|-------------------------|--|--|-----------------|
| 3 | 1 | Equerries and Extra Equerries to other members of the Royal Family | When performing the duties of their appointment | Right |
| 4 | 1 | Officers holding personal appointment to the Governor-General | When representing His/Her Excellency | Right |
| | | a. ADC including honorary appointments | When in the presence of His/Her Excellency, except when ordered otherwise | |
| | | b. Officers on the personal staff | When on duty as ADC | |
| | | c. Honorary Physician | Royal or Vice-Regal levels in Australia or | |
| | | d. Honorary Surgeon | On other occasions as ordered by His/Her Excellency | |
| | | e. Honorary Dental surgeon | | |
| 5 | 1 | Australian ADCs appointed to foreign Heads of State on official State visits | When wearing military uniform | Right |
| 6 | 2 | Officers holding personal appointments to Governors of States or Administrators of Australian Territories: a. ADC, including honorary appointments b. Officers on the personal staff | When performing the duties of their appointment | Right |
| 7 | 2 | Officers holding the following appointments: | With orders of ceremonial and Mess Dress when insignia of orders, decoration and medals are worn | Right |
| | | a. Army – Army officers of General rank | | |
| | | b. Army – Retired General officer | Only worn when appointed by CA and performing the role/duties of an Honorary Appointment | |

| Serial | Aiguillette type | Worn by | When worn | Shoulder |
|--------|------------------|--|--|----------|
| 8 | 2 | Officers holding the following appointments: | When performing the duties of their appointment | Left |
| | | a. Military attaché (Washington) or | When in attendance to the Australian High Commissioner or Ambassador or | |
| | | b. Assistant Army Adviser (London) | When appropriate | |
| 9 | 2 | Deputy Military Attaché (Washington) | When representing the Military Attaché (Washington) | Left |
| 10 | 2 | Defence Attaches or advisers and assistant Defence attaches or advisers | With orders of ceremonial and Mess Dress when insignia of orders, decoration and medals are worn | Left |
| 11 | 2 | An officer posted to the appointment of Escort Officer to the Minister for Defence or the Minister for Defence Industry, Science and Personnel | When accompanying the Minister on visits to Defence establishment and on ceremonial occasions | Left |
| 12 | 2 | An Army officer posted to the appointment of Staff Officer or ADC to CDF, VCDF or CA | When accompanying the General officer or as ordered | Left |
| 13 | 2 | An officer posted to the appointment of ADC or MA to a General officer | When accompanying the General officer or as ordered | Left |
| 14 | 2 | An officer appointed as Escort Officer to a visiting officer of an army other than the Australian Army of MAJGEN rank or above | When accompanying the visiting officer | Left |

3.4 The wearing of an aiguillette by:

- a. an Aide-de-camp (ADC) is to conform to the wishes of the personage to whom they are in attendance
- b. a retired General officer appointed by the Chief of Army (CA) when performing the role or duties of an Honorary Appointment is not entitled to wear the aiguillette on any other occasion unless authorised by the CA.

Wearing the aiguillette

3.5 The method of assembling the aiguillette is in Figure 3-1. The short plait and cord are joined to the long plait and cord by a short shoulder strap, which is worked to a button hole to which a small hook is sewn. The shoulder strap of the aiguillette is secured under the epaulette of the uniform by a button or small eyelet. The long plait and cords pass under the arm and the loose end of the long cord is looped over the top of the short cord. A small gold button loop is fixed at the junction of the long and short plaits. The method of wearing the aiguillette on various garments is in Figure 3-2.

Attachment of button loop

3.6 The small gold button loop is attached to the coat or jacket as follows:

- a. **Service Dress.** It is attached to a small hook or button sewn to the body of the jacket centrally behind the lower lapel.
- b. **Safari Suit or open neck shirt.** Attach the aiguillette by the button loop to the top button of the jacket or shirt and then fasten the button, in accordance with (IAW) Figure 3-2. The aiguillette is not worn with the Safari Suit when it is worn as general duty dress with ribbon bar.
- c. **Ceremonial Patrol Blue orders of dress.** Attached by fastening a small button or hook to the jacket just below the top button and hidden from view. When worn on the left, the loop is to pass through the button hole.
- d. **Mess Dress.** It is attached to a small hook or button sewn to the body of the jacket, behind the collar badge when worn, or to a small hook or button behind where the collar badge would be worn.
- e. The aiguillette is not worn when the Utility jacket is worn.
- f. Lanyards and nameplates are worn with aiguillettes as appropriate.

Figure 3-1: Assembly of the aiguillette (left or right)

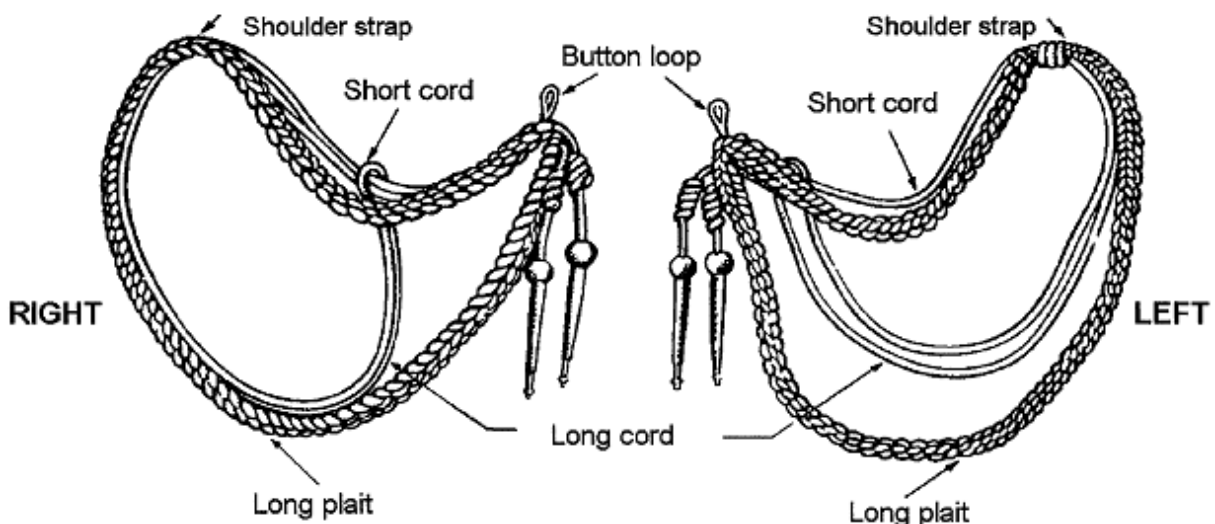
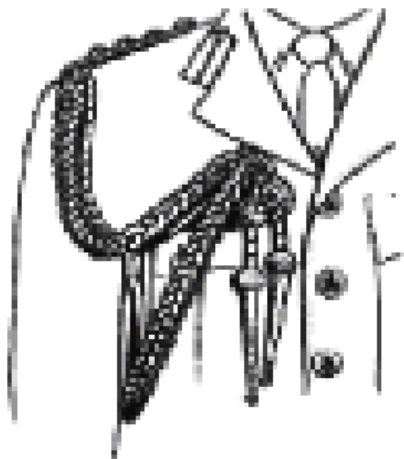

Figure 3-2: Wearing the aiguillette



a. Service Dress Jacket



b. Shirt or Safari Suit Jacket

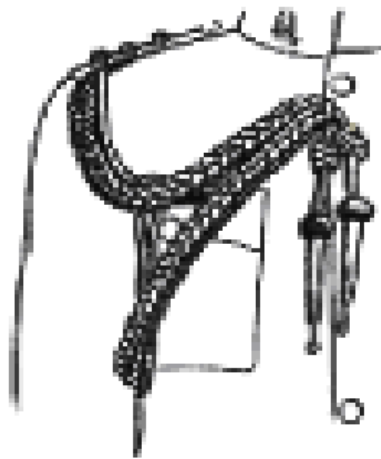

c. Patrol Blue / White Jacket

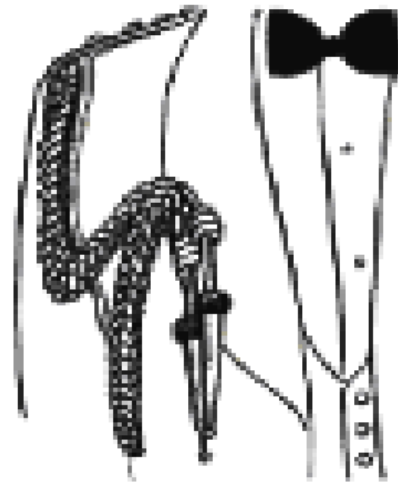

d. Mess Dress

ACADEMIC DRESS

3.7 An academic or ecclesiastic robe may be worn over the Australian Army uniform by a member qualified to wear the particular robe on occasions approved by their commander or commanding officer (CO).

3.8 When a member wears an academic gown or robe over the Australian Army uniform on occasions when headdress is required to be worn, military headdress is to be worn, except that graduating members should wear academic headdress at graduation ceremonies. Academic robes and Academic headdress are not provided at Commonwealth expense.

AUDIO AND VIDEO EQUIPMENT

3.9 Wearing headphones and/or earplugs for recreational use is prohibited when wearing any order of dress, except in authorised or programmed rest periods. They **are not to** be worn when moving around the unit area or in public when wearing the uniform IAW [Chapter 1](#). They may be worn when conducting individual personal training (PT), IAW [Chapter 2](#).

BAGS AND BACKPACKS/CAMELBAKS

3.10 Issued echelon/dive bags are to be carried with the left hand and are not to be carried over either shoulder.

3.11 Sports bags, backpacks and Camelbaks in Australian Multi-cam Camouflage Uniform (AMCU), plain black, olive drab or tan, with a small manufactures logo, if affixed, may be worn with General Duty Dress (AMCU) or PT attire. These backpacks are to be worn centrally on the back using both shoulder straps. When carried, the backpack is to be carried with the left hand. Bags with a single strap **are** also to be carried in the left hand. Backpacks may be worn with other orders of dress on motorcycles/bicycles but must be removed on dismounting.

3.12 Camelbaks are not to be worn in the office environment or whilst travelling in public.

BELTS

3.13 Belts are worn on the waistline, with the buckles of all belts positioned centrally in line with the buttons of shirts or jackets. The positions of belts on various garments are in Figure 3–3, Figure 3–4 and Figure 3–5.

Ceremonial belt

3.14 The ceremonial belt is worn by Warrant Officer Class Two (WO2) rank and below with ceremonial orders of dress and is black with brass keepers, which are to be highly polished. The ceremonial belt may be worn with the polyester skirt by females when wearing ceremonial orders of dress, when not on parade, eg when attending a parade as a spectator. Silver/chromed fittings are worn by Royal Australian Armoured Corps (RAAC), Australian Army Aviation (AA Avn) and Royal Australian Army Nursing Corps (RAANC) personnel. The belt is worn outside garments. Members of the Royal Australian Corps of Military Police (RACMP) wear the white belt and associated equipment, only when performing military police duties. Australia's Federation Guard (AFG) is to wear the white airmen's belt with the Australian Army Rising Sun buckle and brass keepers, which are to be highly polished. Regimental Sergeant Major of the Army (RSM–A), Tier C RSMs, RSM Ceremonial–Army, RSM Royal Military College (RMC) and entitled members posted to RMC wear the white airmen's belt with the Australian Army Rising Sun buckle with Patrol Blue orders of dress. When worn for ceremonial activities the overcoat extreme cold weather is worn with the white airmen's belt with the Australian Army Rising Sun buckle and brass keepers.

3.15 In order to ensure uniformity in appearance the belt is not to be painted or otherwise treated to produce a higher gloss finish. The belt is worn on the waist, with the tongue section of the buckle on the wearer's right hand side.

Sam Browne Belt

3.16 The Sam Browne Belt is a leather belt with metal buckle and fittings and detachable shoulder strap. Members of the RAAC, AA Avn and RAANC wear a black belt and shoulder strap with silver/chromed buckles and fittings. General and Senior officers, RSM–A, Tier C RSMs and members of other Corps wear brown leatherwork with brass buckles and fittings. The Sam Browne Belt is worn by officers and Warrant Officer Class One (WO1) with all orders of ceremonial dress and ceremonial parade dress. The Sam Browne Belt is worn by Adjutants (ADJTs), RSMs and Master Gunner Joint Fires, Headquarters (HQ) 6 Brigade (Bde) when wearing General Duty Dress (polyesters) and General Duty Service Dress. However, when working in the office environment, the Sam Browne Belt may be removed within and replaced with the waist belt 32 mm, in order to execute staff or office duties. The Sam Browne Belt is worn with all ceremonial orders of dress at all times by an RSM, except when wearing white slung equipment as a member of a Colour Party. The Sam Browne Belt is not to be worn with Patrol Blue orders of dress, Utility jacket, Garrison jacket, or AMCU. Sword accessories are not worn on the belt if a sword is not being worn. The belt is not worn when travelling in Australian Army uniform on civilian aircraft; the waist belt 32 mm is to be worn in lieu. The Sam Browne Belt is worn on the waist, with the shoulder strap passing over the right shoulder, under the epaulette. The short section of the shoulder strap is worn to the front, the long section to the rear. Belt hooks are used when the Sam Browne Belt is worn with trousers, skirt and shirt, [IAW Figure 3–4](#).

Waist belt 32 mm

3.17 The waist belt is a khaki web belt, 32 mm wide, and is worn with a stainless steel buckle which is not to be polished or embellished. A white waist belt is worn with Ward Dress. A dark green waist belt with black buckle is worn with the AMCU flying suit by AA Avn and with the AMCU tank suit by RAAC. The belt is to pass through all loops and is to be adjusted so that the free end protrudes through the buckle on the wearer's left side to a distance of not more than 2 cm. The other end of the belt is to be trimmed so that no material is visible under the buckle. The belt is worn with the buckle aligned centrally to the body, with the centre of the buckle in line with shirt buttons and the trouser fly, [IAW Figure 3–5](#).

Figure 3-3: Wearing the ceremonial belt

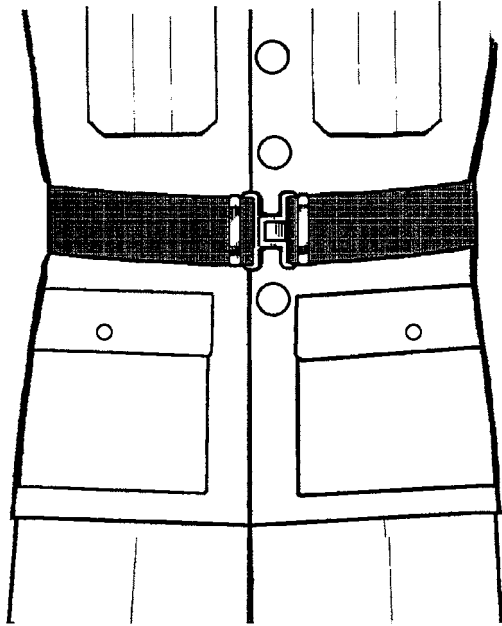

a. Jacket

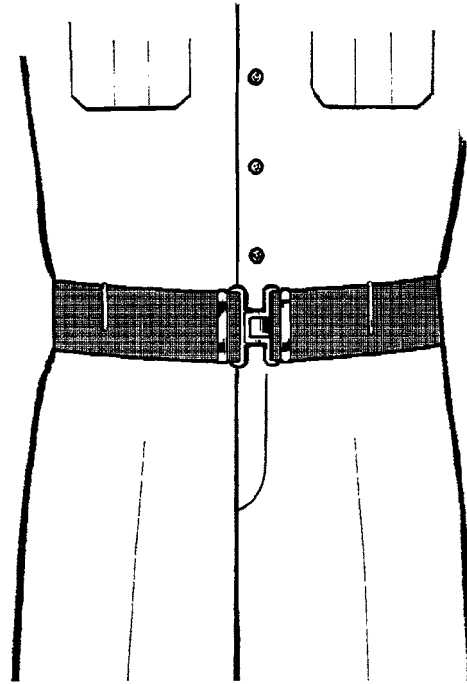

b. Shirt

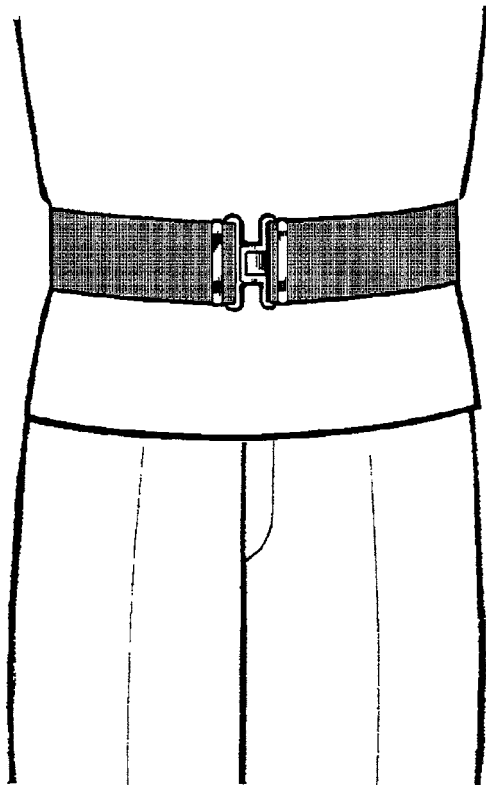

c. Sweater Khaki Lightweight

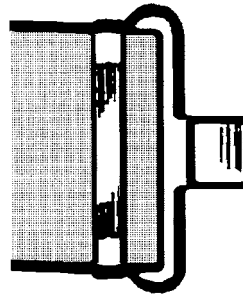

Right

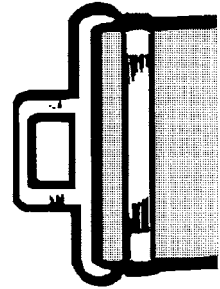

Left

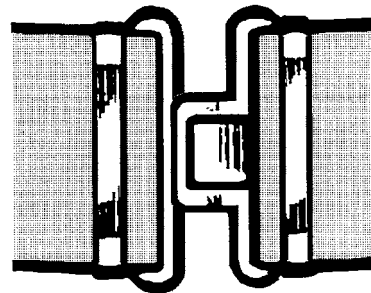

d. Buckle Detail

Figure 3-4: Wearing the Sam Browne Belt

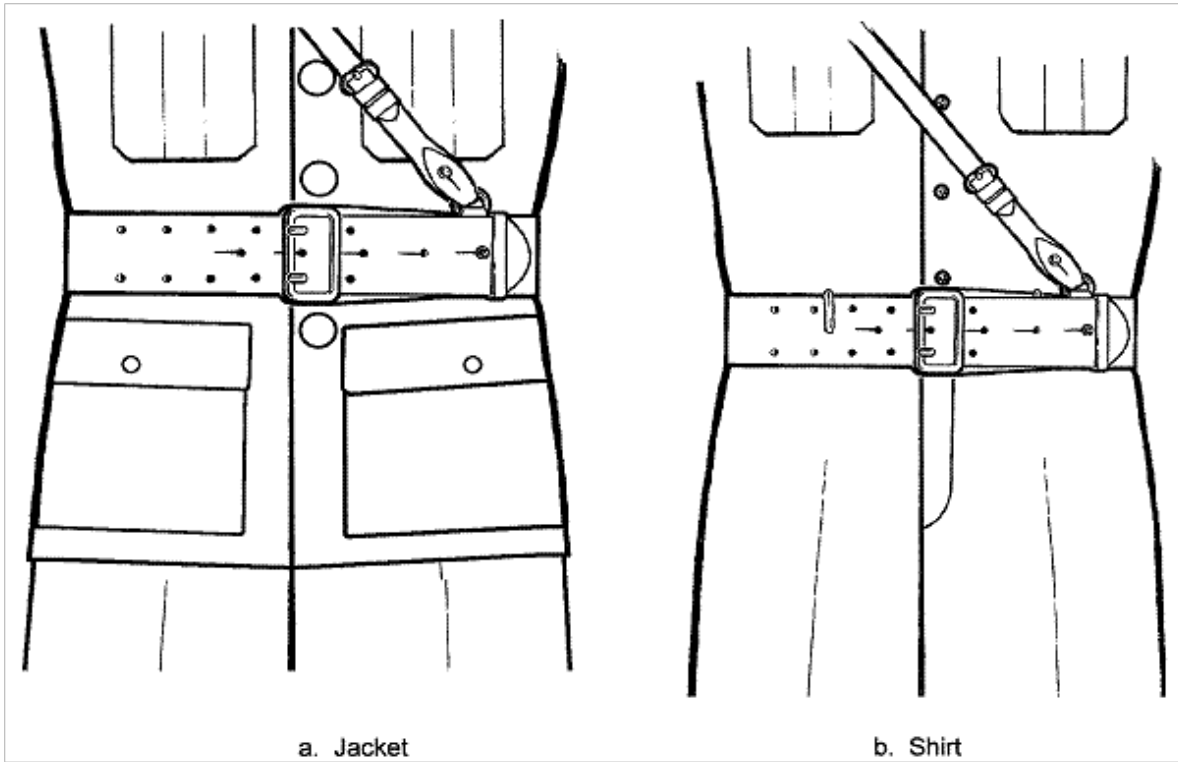
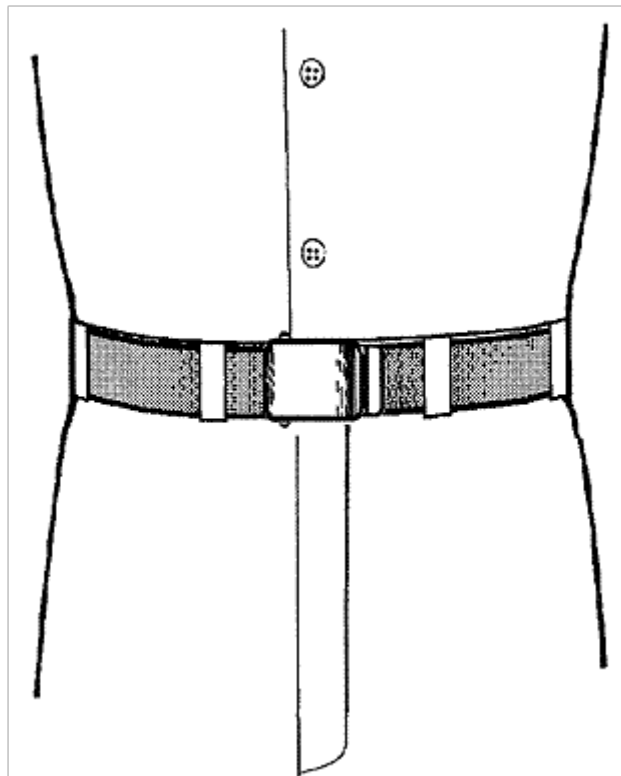

Figure 3-5: Wearing the waist belt 32 mm



Colour belt

3.18 Colour belts are ceremonial belts designed to carry colours on ceremonial parades. They may be plain belts with ornamental fittings or they may be embroidered with regimental heraldry. Colour belts are worn over the left shoulder. They are not secured by wearing under a waist belt, but may be fastened on the right-hand side by an improvised attachment, that cannot be seen. Training colour belts may pass under a waist belt at the right-hand side.

BELT HOOKS AND KEEPERS

3.19 Belt hooks and keepers, in Figure 3-6 to Figure 3-10 are to be worn on polyester skirts, trousers and slacks when either the ceremonial belt or the Sam Browne Belt (without keepers) is worn. Both the flat faced belt hooks and rolled brass belt hooks, with eyelets versions may be worn. Belt hooks and keepers are not worn with the khaki waist belt. Silver/chromed coloured belt hooks and keepers are worn by members of RAAC, AA Avn and RAANC. All other personnel, including RSM-A and Tier C RSMs wear gold coloured hooks and keepers. The hooks are worn so that they face downwards, with the outer portion of the hook over the front of the belt. There is no provision for wearing hooks and keepers with jackets. Belt hooks and keepers are to be highly polished.

Figure 3-6: Female buckle



Figure 3-7: Male buckle



Figure 3-8: Keeper



Figure 3-9: Hooks (flat face)

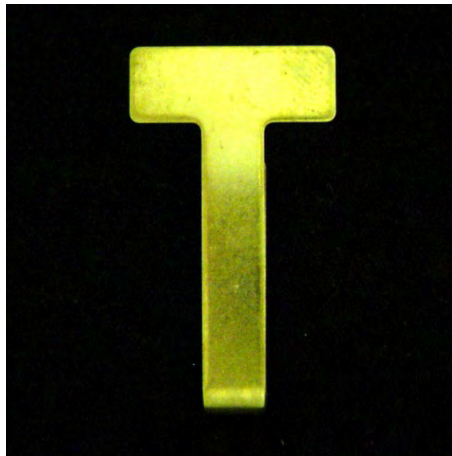

Figure 3-10: Hooks (rolled brass)



BANDOLIERS

3.20 Bandoliers are worn as ordered by WOs, Non-Commissioned Officers (NCOs) and Other Ranks (ORs) posted to RAAC units, with ceremonial orders of dress during ceremonial parades.

3.21 The general design of the bandolier is to be based on the World War One Light Horse Pattern, with five ammunition pouches to the front and four to the rear. Bandoliers worn for dismounted parades are to be black leather; bandoliers worn for

mounted parades are to be brown leather. The buckles and fasteners of both black and brown bandoliers are to be chromed or silver.

3.22 Bandoliers are worn on the left shoulder and fastened under the epaulette, with the adjustment buckle positioned to the lower right rear above the waist belt.

BASEBALL CAPS

3.23 Baseball caps are authorised to be worn with PT attire, excluding battle PT. The AMCU Field cap may worn for battle PT. The AMCU field cap is to be worn [IAW para 3.90](#).

3.24 When conducting PT and sporting activities, outdoors headdress of a baseball/kepi design or a hat with a wide brim may be worn. Adequate sun protection for the ears and the back of the neck is to be provided either with the use of sun screen or the wearing of appropriate headdress.

BRASSARDS

3.25 Brassard of an approved design may be worn on the left arm as follows:

- a. Members posted to UN or MFO missions bearing the UN/MFO insignia.
- b. When wearing AMCU, members entitled to wear a Red Cross identification arm patch, may wear a brassard if the purpose made velcro patch on the right sleeve has been utilised for the Australian National Flag (ANF) patch. The brassard is to display both the ANF and the Red Cross identification arm patch, in that order.
- c. For Military Police (MP) wearing General Duty Dress (polyesters), the brassard is made in the same material as the shirt with a 9 cm scarlet band attached with 40 mm letters 'MP' in black. When wearing General Duty Service Dress, a 9 cm scarlet band with 40 mm letters 'MP' in black is worn in lieu of the brassard. MPs wear the MP brassard or scarlet band on the right sleeve.

BRACES

3.26 Braces may be worn with orders of dress which include a jacket. They are not provided at Commonwealth expense. If braces are worn with mess dress orders of dress, they are to be white.

BREECHES

3.27 Breeches may be worn by a member authorised to wear Military Equestrian Dress when riding in uniform.

BOOTS AND FOOTWEAR

3.28 Only approved patterns of boots and footwear are to be worn.

Black shoes and black court shoes

3.29 Black shoes are black leather shoes which may be worn with General Duty Dress (polyesters), General Duty Service Dress and mess dress orders of dress. Black Court shoes (not wedged) or Black shoes may be worn with General Duty Dress (polyesters), General Duty Service Dress, mess dress orders of dress and when wearing skirts. Heeled black court shoes are not worn when conducting nursing duties or driving duties in military vehicles other than staff cars.

3.30 The issued Black shoes are no longer an Initial Free Issue, but may continue to be worn until they become unserviceable. Black shoes may continue to be purchased at the members' expense from Area Clothing stores until stocks run-out. IAW Figure 3-11, Court Shoes purchased from non-ADF sources must be black in colour and not incorporate any extremes of style or height. They may either be of plain (brush-polished) or patented leather and are to be free of embellishments such as buckles, textured features or stitched detail.

3.31 The basic specifications for court shoes are:

- a. Manufactured from plain or patent leather.
- b. Black, plain in style and finish with no extremes of fashion.
- c. Heel can be flat, or the height measured at the rear of the heel is to be between 2cm and 8cm.
- d. Heel width (base of heel from rear edge to inner straight edge) is to be between 2cm and 4cm.

Figure 3-11: Acceptable Court Shoe



Patent leather black boots

3.32 Patent leather black boots are ankle-high black patent leather boots which may be worn with General Duty Dress (polyesters), General Duty Service Dress, ceremonial and mess dress orders of dress. Patent leather boots are to be

maintained in good repair, ie clean and without scuff marks. Patent leather black boots may be worn on ceremonial parades.

Elastic sided black leather boots

3.33 The issued R.M. Williams Elastic sided black leather boots are ankle-high black leather boots which may be worn with General Duty Dress (polyesters), General Duty Service Dress, ceremonial and mess dress orders of dress. Boots are not to be worn with the skirt or dress. The issued R.M. Williams Elastic sided black leather boots are to be brushed polished black and may be worn on ceremonial parades. In addition, the following styles of Elastic sided black leather boots are suitable for both males and females, are purchased at the members' expense and may only be worn with General Duty Dress (polyesters), General Duty Service Dress and mess dress orders of dress:

- a. **R.M. Williams.** Dress Craftsman, Dress Wentworth, Dress Tambo, Dress Jodhpur, Dress Gardener and Dress Blaxland Craftsman.
- b. **Baxter.** Rider, Charles, Henry Baxter, Drover and Horseman.

3.34 **Care of RM Williams boots.** Properly cared for, RMW boots will retain their appearance and will remain comfortable over their life. Leather is a natural product so your boots will benefit if the following advice is observed:

- a. Always use the two 'tugs' when pulling on the boots; this will keep the back strong and spread the strain over the 'tugs' and the elastic.
- b. When removing the boots, pull the boot from the heel, levering off with the other hand on the toe area. Do not remove the boots by using the toe of the other foot to pull them off, it will damage the back of the boot.
- c. Wear the boots, if possible, in dry conditions on the first few occasions.
- d. If the boots become saturated with water, allow them to dry naturally; never use direct or forced heat, as will damage the leather upper and may damage the sole.
- e. Mud or dirt should be removed from the boots while they are still wet, using a damp cloth and then waiting until dry before cleaning and polishing.
- f. Leather conditioner should be applied regularly (every six weeks in humid conditions or as the leather becomes dry). This will help maintain supple leather uppers and prevent cracking and excessive creasing.
- g. Boots stored in humid environments must be dried naturally before storing, and must have adequate ventilation to avoid the growth of mould on the leather.
- h. Water-based polish should be used to obtain a shine.
- i. Additions or modifications to either sole or heel, such as synthetic top-soles should be avoided, as these can affect the balance and comfort of the boots and can lead to premature failure in either the sole or the upper.

- j. The use of any alcohol or oil based care products may cause damage to the upper leather and void the warranty.

Combat boots

3.35 The combat boot is the normal footwear for all ranks with AMCU dress. Combat boots are to be maintained in good repair and kept clean, and not to be polished but treated, IAW the manufacturer's instructions. AMCU field and combat trousers are worn bloused over the top of the boot with the trouser legs held securely in place by elastics. The combat boot is also worn with Protective Dress when not wearing safety boots or safety shoes. CA endorsed range of combat boots (commercial off-the-shelf combat boots) may be worn with General Duty Dress (AMCU), field, operations and battle PT orders of dress. All members may purchase, at their own expense, the CA endorsed range of combat boots that are similar in colour as the in-service/issued combat boot. CA endorsed range of combat boots are in [Annex 3A](#). Personnel are invited to nominate their suggestions for alternate boots, through their respective chain of command, to be tested by Capability Acquisition and Sustainment Group (CASG), to ensure they meet Army's standards. Once CASG has confirmed that the nominated combat footwear has met Army's standards, [Annex 3A](#) will be up-dated by Ceremonial Cell accordingly.

3.36 **Extreme cold weather boots.** The extreme cold weather boot may only be worn with Field Dress (AMCU), when on exercise in the field or deployed on operations.

Black combat boots

3.37 Black combat boots are only to be worn by those personnel who have a uniform entitlement to the AMCU FR ensemble and are wearing it on task, as well as those personnel involved in TAG operations. Descriptions and images of endorsed black combat boots are in [Annex 3B](#).

Safety boots and shoes

3.38 When directed by COs, safety boots and shoes are to be worn with Protective Dress when performing tasks which involve risk of injury to personnel. Safety boots may be worn with AMCU, but only when the nature of the task demands.

Laces

3.39 Combat boots are to be laced IAW the manufactures instructions. In the absence of any instructions all footwear is to be laced as follows:

- a. the initial lace is to be horizontal across the inside of the footwear, through the lowest eyelets on each side of the boot and shoe
- b. subsequent laces are to continue diagonally, outside over inside, upwards through all eyelets, to the top of the boot and shoe
- c. laces are tied neatly at the top of the boot and shoe after laces have been passed through all eyelets.

BRIEFCASES

3.40 Briefcases carried when wearing uniform are to be black, brown or silver in colour. They are to be carried with the left hand.

BUTTONS

3.41 Buttons are to be attached to garments with embossed designs vertically aligned. On shoulder straps or epaulettes, the designs point toward the neck.

3.42 **Size.** Button size is measured by the diameter. The unit of measure is 'lines' and 30 lines equal 2 cm, [IAW Figure 3-12](#).

Figure 3-12: Line 30 button and line 30 button (screw-in)



3.43 **Design and colour.** Buttons are colour anodised, gold (to be worn by Senior and General officers and the wider Army), chrome/silver (to be worn by RAAC, AA Avn and RAANC) and black (to be worn by 51 Far North Queensland Regiment (FNQR) and Sydney University Regiment (SUR), and are embossed with the Australian Army Rising Sun Badge design. The Army button replaces all other buttons and no other Corps or Regimental buttons are to be worn.

3.44 Buttons sizes are to be worn, [IAW Table 3-2](#).

Table 3-2: Button sizes

| Serial | Item of Dress | Size and position – Line 40 | Size and position – Line 30 | Size and position – Line 20 |
|--------|-----------------------------|-----------------------------|--|-----------------------------|
| 1 | Patrol Blue orders of dress | Front | All pockets, epaulettes ^{Note (a)} | – |
| 2 | Highland jacket | Front | Shoulder straps, cuffs, sashes ^{Note (a)} | – |
| 3 | Service Dress jacket | Front | All pockets, epaulettes ^{Note (a)} | – |
| 4 | All Mess Dress jackets | – | Epaulettes ^{Note (a)} | – |
| 5 | Mess Dress waistcoats | – | – | Front |
| 6 | Blue Service cap | – | – | Chinstrap |
| 7 | Gorget patches | – | – | Point |

Note:

- (a) Screw type buttons on epaulettes.

CANES

3.45 When not on a ceremonial parade with troops, an ADJT, WO or Senior Non-Commissioned Officer (SNCO) may carry a cane not exceeding 60 cm in length with the approval of a CO. Canes are to be made of cane or timber, in one colour and without engraving/etching or carvings, and may be fitted with metal embellishments. They are to be finished in natural colours except that authorised RAAC, AA Avn and RAANC personnel may carry black canes with chrome/silver fittings. A cane (swagger stick) in Figure 3-13, may be carried by an ADJT. Canes are carried in the manner, IAW [Land Warfare Procedures-General \(LWP-G\) 7-7-5-Drill](#)¹⁰. Canes are not provided at Commonwealth expense.

3.46 A member of the Corps of Staff Cadets may carry a cane of the approved pattern as ordered by the Commandant (COMDT).

3.47 Canes may be carried for instructional purposes by instructors and trainees on WO and NCO promotion courses.

¹⁰ <http://intranet.defence.gov.au/DRMS/uA14558/I2010830.pdf>

Figure 3-13: Cane (swagger stick) Adjutant



CARDIGANS

3.48 The khaki cardigan may be worn by female nursing personnel with Working/Protective Dress and Maternity Dress. The cardigan may be worn unbuttoned by pregnant personnel. The cardigan cannot be worn with any ceremonial orders of dress.

COMMUNICATION EQUIPMENT

3.49 Pagers and mobile telephones may be carried or worn. These items are not to be worn with ceremonial or parade orders of dress. When worn with the Australian Army uniform, they are to be attached to the belt at the left-hand side of the body. These items should be removed from the belt prior to fastening seat belts and or driving a vehicle. Communication equipment is not worn on the Sam Browne Belt.

EMU PLUMES

3.50 Emu plumes are worn on the Hat KFF by all members of RAAC and members posted to RAAC units. Emu Plumes may be worn by RAAC General and Senior officers, and Tier C RSMs who have been entitled to wear the accoutrement, prior to the assumption of their current appointment. Plumes are worn on the left side of the Hat KFF, brim worn up or down, positioned behind the puggaree. The item is not provided at Commonwealth expense.

3.51 The plumes are to be shaped to allow the feathers to bend to the right over the hat. Only natural emu feathers are to be worn. Shades may therefore, vary between individual sets. The specifications for emu plumes are in Figure 3-14.

EMU TUFTS

3.52 Emu tufts of approved design and headdress may be worn on the beret by members posted to any of the entitled RAAC Regiments in Table 3-3. The CO is to set the policy whether the emu tuft is or is not worn. If worn or not worn, there is to be uniformity within that regiment.

3.53 The emu tuft is worn fastened behind the badge worn on the beret. The item is not provided at Commonwealth expense. The specifications for emu tufts are in Figure 3-15.

Figure 3-14: Specifications for emu plumes

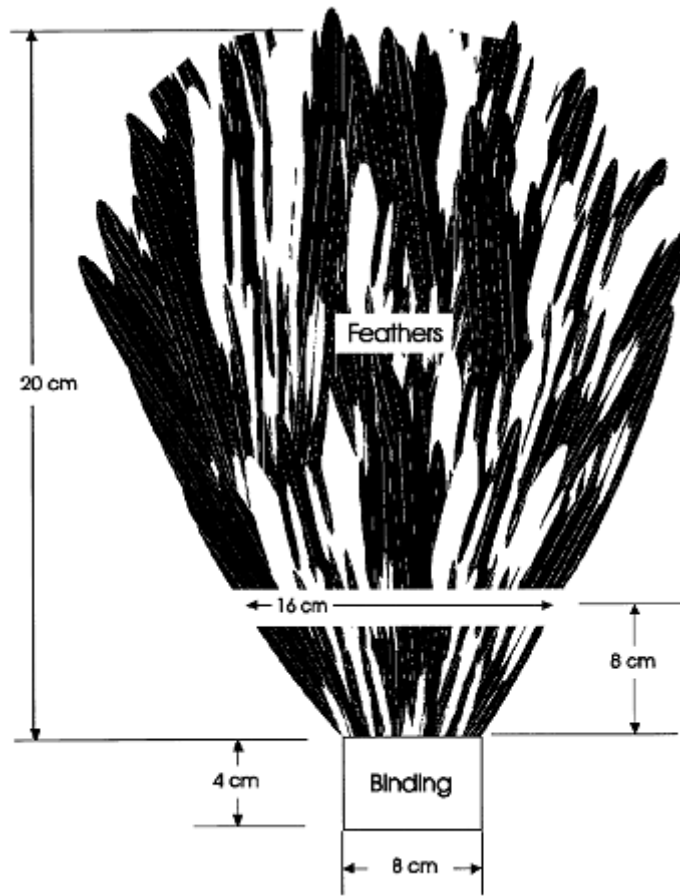
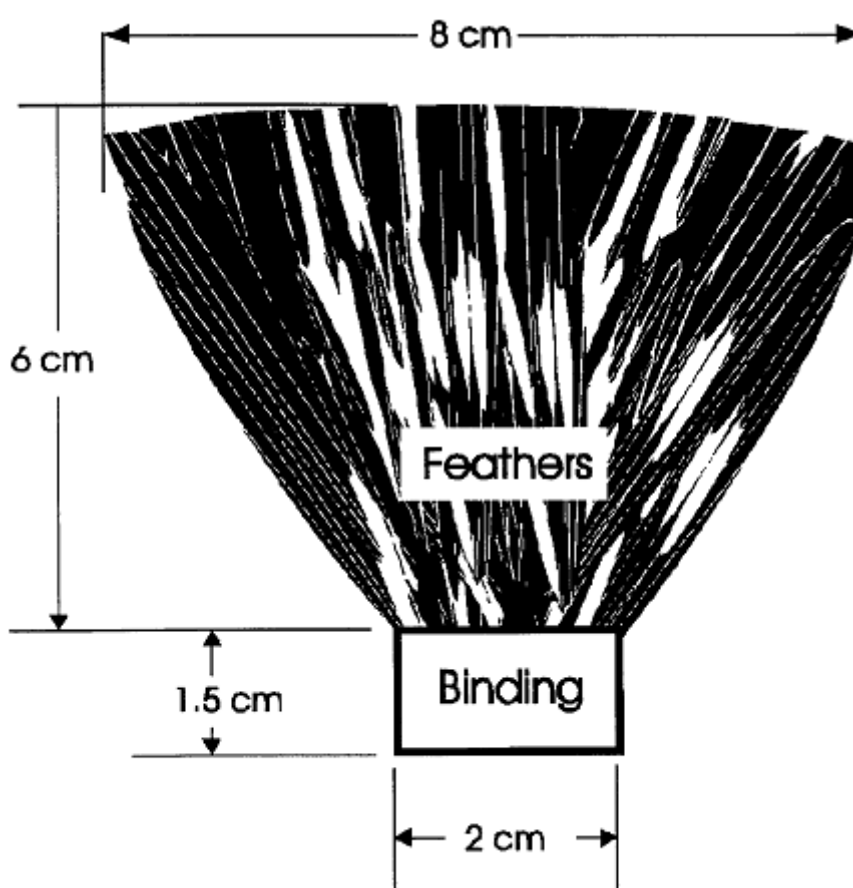

Table 3-3: RAAC Regiments entitled to emu tufts

| Serial | Regiment |
|--------|--|
| 1 | 1st/15th Royal New South Wales Lancers |
| 2 | 2nd Cavalry Regiment (Reconnaissance) |
| 3 | 2nd/14th Light Horse (Queensland Mounted Infantry) |
| 4 | B Squadron, 3rd/4th Cavalry Regiment |
| 5 | 3rd/9th Light Horse (South Australia Mounted Rifles) |
| 6 | 4th/19th Prince of Wales's Light Horse |
| 7 | A Squadron, 10th Light Horse |
| 8 | 12th/16th Hunter River Lancers |

Figure 3-15: Specifications for emu tufts



FACE MASK

3.54 Army members must wear a face mask IAW applicable State, Territory and Federal health directives when required. Face masks must conform to the Australian department of health. It is the responsibility of all personnel to wear a face mask that does not detract from the high standard of dress and appearance expected of a professional military force.

3.55 All cloth and non-disposable masks are to be plain black in colour. All disposable masks worn are to be plain in colour, either green, white or blue.

3.56 When participating in representative appointments or ceremonial activities, the face mask worn is to be the authorised issued plain black face mask.

GLOVES

Dark brown or black leather gloves

3.57 Dark brown or black leather gloves, according to corps, may be worn by all ranks in general duty and ceremonial orders of dress. Gloves are not provided at Commonwealth expense, unless posted on representational positions in selected countries, detailed in Block Scales 3002-24 and 3002-25.

White kid gloves

3.58 White kid gloves are worn by the following with ceremonial orders of dress:

- a. General officers
- b. Officers holding personal appointments to the Sovereign, Governor-General or State Governor
- c. other entitled officers, IAW [Chapter 1](#).

White gauntlet gloves

3.59 White gauntlet gloves are worn by Drum Major, bass drummers, cymbal players and members of RACMP.

White cotton gloves

3.60 White cotton gloves are worn by:

- a. Staff Cadets (SCDTs) of the Corps of Staff Cadets with Patrol Blue orders of dress.
- b. members of a Colour/Flag Party
- c. personnel handling Flags, Colours, Standards, Guidons or Banners at any time
- d. members of the AFG, when ordered.

HANDBAGS AND CLUTCH BAGS

3.61 Women wearing the Australian Army uniform may carry a plain black leather handbag with general duty orders of dress. A plain black clutch bag may be carried with mess dress orders of dress. The handbag is to be carried as follows:

- a. over the left shoulder
- b. by a shortened strap in the left hand
- c. on the left forearm
- d. clutched in the hand.

HEADDRESS

3.62 The signature headdress of the Australian Army is the Hat Khaki Fur Felt (Slouch Hat). The Slouch Hat is known and respected around the world and across the Australian community. Members should be proud to wear it and do so on every possible occasion.

3.63 Correct headdress is to be worn at all times whilst wearing the Australian Army uniform on Defence establishments and in public, including: shopping centre and airport common areas, carparks and outdoor public areas. Headdress is not to be worn in the following circumstances:

- a. when entering the office environment
- b. when in a vehicle, unless participating in a ceremonial parade
- c. when attending an indoor or outdoor church service, unless participating in a designated ceremonial role
- d. when entering messes, clubs, restaurants, cafeterias, eateries and individual shops but must be worn when exiting
- e. when refuelling a vehicle at a service station
- f. when moving to and from the office or workplace to a motorcycle but must be carrying a motorcycle helmet
- g. when awaiting and/or boarding a civilian or military aircraft or any public transport asset
- h. when in a public area or Defence establishment, but must be carrying a motorcycle helmet.

Hat Khaki Fur Felt

3.64 The Hat KFF (Slouch Hat) is worn with hat badges, chinstrap, puggaree and a Unit Colour Patch (UCP), except for 1 Royal Australian Regiment (RAR). The hat is worn with the crown indented. The hat is not to be pinned or stitched where the crown is indented. With ceremonial orders of dress, the Ceremonial Hat KFF (Slouch Hat Grade One) brim is to be flat and turned up on the left side. With all general duty orders of dress, the General Duty Hat KFF (Slouch Hat Grade Two) brim **is to be flat** and turned down.

3.65 When the Ceremonial Hat KFF is worn with ceremonial orders of dress, the Australian Army Rising Sun Badge is to be worn on the left-hand side. The Corps/Regiment badge is worn on the front of the puggaree with the base of the badge touching the brim of the hat, on the Ceremonial Hat KFF (brim up) and the General Duty Hat KFF (brim down). The designated UCP is worn centrally on the right side of the puggaree on the Ceremonial Hat KFF and the General Duty Hat KFF.

3.66 With all general duty orders of dress, including Protective Dress and those with a jacket, ie Service Dress and Utility jacket, the General Duty Hat KFF is to be worn. The beret may be worn, [IAW paragraph 3.80](#).

3.67 The Ceremonial Hat KFF is to be worn by all personnel who participate in or attend as a spectator at a ceremonial parade external to barracks/Defence establishments, on occasions of National significance and activities when the Army as a whole is being officially represented in the public domain, [IAW paragraph 3.65 and 3.74](#). However, the beret may be worn by personnel who participate in or attend

as a spectator at an internal/barracks/Defence establishment ceremonial parade, held by a Corps/Regiment/Unit/Sub-unit that does not include other Service contingents, [IAW paragraph 3.80](#), unless specified otherwise in parade instructions.

3.68 The Hat KFF is to be worn with ceremonial and general duty orders of dress by all ranks who participate in an Army or tri-Service overseas contingent or exercise which is not a UN or MFO deployment.

3.69 When representing the Australian Army whilst overseas on posting, course or deployment, the prominent headdress to be worn by all members **is the** Hat KFF.

3.70 Recruits at training establishments may be ordered by the commander or CO to wear the Ceremonial Hat KFF (brim-up), when wearing General Duty Dress (AMCU).

3.71 The Hat KFF is the head Dress for AHQ and all senior officers COL and above. Tier C RSM and Tier B RSM no longer filling a Corps role or posted to a formation where the beret is worn (eg HQ ADF).

Chinstrap

3.72 The chinstrap is to be of brown leather. It is to be worn at the point of the chin with the lower buckle positioned on the left cheek so that it is level with the corner of the mouth when the hat is worn with the brim up. When the brim is worn down and the hat is worn level on the head, the chinstrap buckle will be positioned slightly below the corner of the mouth. The metal fittings are not to be polished. Members of the Corps of Staff Cadets wear the buckle on the right cheek.

Puggaree

3.73 All members, except personnel posted to 1 RAR and members of the Corps of Staff Cadets are to wear a khaki puggaree. Personnel whilst posted to 1 RAR wear a green puggaree and RMC SCDTs wear a distinctive olive drab puggaree. The UCP is worn centrally on the right side of the puggaree.

Wearing the Hat Khaki Fur Felt

3.74 With ceremonial orders of dress, the hat is inclined to the right so that a distance equivalent to three fingers width between the brim and the highest point of the left ear is achieved. When the brim is turned down, the hat is worn level on the head and the brim may be curved downwards so that the front and rear of the brim fall no more than 2 cm below the brim's highest point. The correct method of wearing the Hat KFF is in Figure 3–16 and Figure 3–17. Badges are positioned, [IAW Chapter 4](#).

Figure 3-16: Wearing the Ceremonial Hat Khaki Fur Felt—brim up

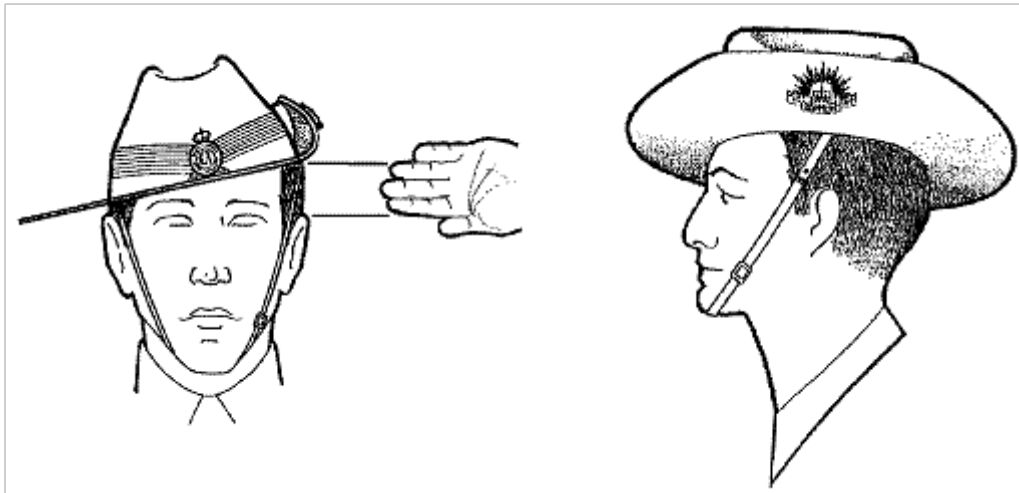
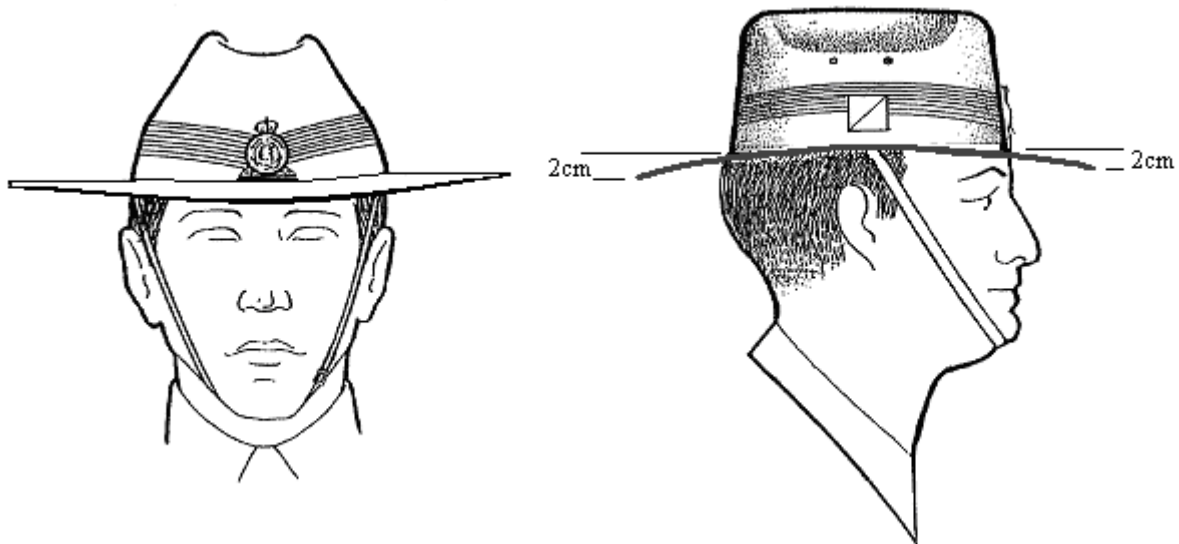

Figure 3-17: Wearing the General Duty Hat Khaki Fur Felt—brim down



Beret

3.75 Army headdress **is** the Slouch Hat IAW paragraph 3.59. A Commander/CO must ensure that the Slouch Hat remains the Australian Army’s primary form of headdress.

3.76 A Commander/CO may authorise the wearing of a beret as an alternative form of headdress with general duty dress (Dress Order 4A, Dress Order 2E and 2F) by all ranks. The authorisation may also include the wearing of the beret at an internal/barracks/Defence establishment ceremonial parade that is held by a Corps, Regiment, unit or sub-unit. The beret **is not** to be worn with ceremonial orders of dress unless on a mounted parade.

3.77 Corps, Regiments and Unit berets. Corps, Regiments and Unit berets may be worn by all ranks at Formation Headquarters (SOCOMD and AAVNCOMD) and unit level that have an **entitlement** to wear a Corps, Regiments and Unit berets **except** for the following:

- a. ceremonial activities when wearing any order of dress that requires medals or ribbons to be worn (eg unit parades, memorial services, funerals, dismounted ceremonial parades etc)
- b. parading or spectator at ceremonies on occasions of National significance or on dismounted ceremonial parades which include other corps or Service contingents, eg ANZAC/Remembrance Day and the Last Post Ceremony at the Australian War Memorial
- c. part of a contingent whilst posted overseas, on exercise, on course or visiting overseas
- d. when officially representing Army and Defence during an International posting engagement at an Embassy, foreign training establishment or foreign unit
- e. in the field, on exercise or operations, both within Australia and overseas, when authorised by the Commander/CO. Other authorised field headdress is to be worn, unless posted on United Nations (UN) or Multi-national Force/Observer (MFO) duty
- f. when officially representing Army in the public domain, eg selling legacy badges or poppies.
- g. Ramp Ceremonies in any Dress Order
- h. when travelling on civilian aircraft
- i. when posted outside of Army eg HQ ADF and JOC
- j. Senior Officers COL and above except those posted within SOCOMD and AAVNCOMD
- k. Tier C WO/Tier D WO except those posted within SOCOMD and AAVNCOMD
- l. Tier B RSM when no longer holding a Corps position except those posted within SOCOMD and AAVNCOMD.

3.78 Berets may be worn by members IAW Table 3-4.

Table 3–4: Berets

| Serial | Type | Colour | Worn by |
|--------|------|-----------|--|
| 1 | Army | Dark blue | All members of the Army who are not eligible to wear a special to corps, regiment or unit beret listed below <small>Notes (b), (c) and (d)</small> |

| Serial | Type | Colour | Worn by |
|--------|--|----------------|---|
| 2 | RAAC | Black | Members of RAAC and members of other corps posted to a RAAC unit. Non-RAAC members wear their own corps hat badge ^{Notes (a),(b) and (c)} |
| 3 | RAR | Rifle green | Members entitled to wear RAR embellishments ^{Notes (b) and (c)} |
| 4 | AA Avn | Light blue | Members of AA Avn and members of other corps posted to units within Aviation Command and Army members seconded for duty with RAAF in support of Army aviation. Non-AA Avn members wear their own corps hat badge ^{Notes (a), (b) and (c)} |
| 5 | RACMP | Scarlet | Qualified members of the RACMP ^{Notes (b) and (c)} |
| 6 | Airborne | Dull cherry | Personnel posted to 176 Air Dispatch Squadron, Air Movements Training and Development Unit or Parachute Training School and are parachute qualified are to wear parent Corps or regimental hat badge. Members who are qualified para riggers and are posted to a para riggers position are to wear parent Corps or regimental hat badge. The para rigger conductor when performing duties of the conductor within RAAOC ^{Notes (a), (b) and (c)} |
| 7 | Commando | Sherwood green | Members who are commando qualified are to wear the beret IAW Annex 2A |
| 8 | SASR | Fawn | Member who are SASR qualified are to wear the beret IAW Annex 2A |
| 9 | RAANC | Slate grey | All members of the RAANC unless posted to RAAC or AA Avn unit ^{Notes (b) and (c)} |
| 10 | United Nations (UN) | Light blue | Members who are posted to UN appointments are to wear the UN hat badge. Former members of UN contingents may only wear the UN beret with UN hat badge at commemorative ceremonies when held on United Nations Day (24 October) of every year or during other specific UN celebrations ^{Note (c)} |
| 11 | Multi-National Force and Observers (MFO) | Terracotta | Members who are posted to MFO appointments are to wear the MFO hat badge. Former members of the MFO may only wear the MFO beret with MFO hat badge at MFO commemorative ceremonies ^{Note (c)} |

Notes:

- (a) On reposting from corps units, members of other Corps are to cease wearing that special to Corps/Unit beret.
- (b) Officers of the rank of Colonel and above, except those holding Corps/Regimental or honorary Corps/Regimental appointments of Corps or Regiments having distinctive berets, are to wear the Army beret.
- (c) Cloth embroidered beret badges are only to be worn by Officers of the rank of Colonel and above when authorised to wear a beret/posted to a formation such as AAavn BDE or SOCOMD.

- (d) The Army blue beret is only worn by those members whose not entitled to wear a Corps or regimental beret when posted to a unit that wear a specific regimental beret such as member who is not of the RAR would not wear rifle green beret but the Army dark blue for the duration of that positing to a battalion within the RAR if that battalion CO choose to wear the RAR beret.

Wearing the beret

3.79 Berets are to be purchased at the members' expense-Commonwealth funds are not be used to purchase berets. The beret is to be worn with the band level on the forehead and level from front to rear on the left side. The lower edge of the band is to be 2 to 3 cm above and parallel to the eyebrows. The crown of the beret is to be pulled down to the right and the Corps, regiment or unit badge is to be positioned vertically over the left eye, IAW Figure 3-18. The badge is positioned centrally on the backing provided with the lower edge 1 cm above the band, IAW Figure 3-18 and [Annex 4D](#). The beret is not to be carried tucked under the epaulette, through the belt loop or in pockets when it is not worn. The ribbon within the band is finished in a small, neat bow at the rear of the beret. The bow is to be sewn to the band.

Figure 3-18: Wearing the beret



Corps/Regimental/Unit hat badges

3.80 When authorised to wear a beret, the hat badge of the specified Corps/Regiment/Unit is worn. Royal Australian Artillery (RAA) members are to wear the miniature RAA hat badge in lieu of the large RAA hat badge when wearing the beret. The miniature RAA hat badge is to be purchased at the members' expense. Only RAA officers may wear the coloured embroidered cloth hat badge on the beret in lieu of the metal hat badge. The coloured embroidered hat badge is to be purchased at the members' expense.

Special Operations Command Corps/Regiment hat badges

3.81 When authorised to wear a beret, Special Forces (SF) members posted to Special Operations Command (SOCOMD) units are to wear the hat badge and embellishments of their qualification. Non-qualified SF members posted to SOCOMD units are to wear their respective SOCOMD unit hat badge when wearing the beret or Hat Khaki Fur Felt (KFF).

3.82 SOCOMD units with non-qualified SF members are to wear the Army/Service blue beret respective Corps Beret. The wearing of the SOCOMD unit beret, embellishments and accoutrements are in [Annex 2A](#).

Special considerations, risk assessment and sun protection

3.83 Members assessed by a Resident Medical Officer/Senior Medical Officer as being at additional risk to exposure from the sun or where individuals have a medical restriction which requires them to minimise their exposure to direct sunlight, may wear the Hat KFF. Regardless of any other provisions, individuals may elect to self-assess and wear the Hat KFF any time during any circumstance or occasion. No pressure is to be placed on an individual to wear a beret due to their concerns over exposure to the sun.

3.84 When berets are authorised to be worn, sun protection **is also** to be applied. Commanders and individuals are to ensure that sun exposure risks are appropriately mitigated during periods of outside activity in the sun. The onus rests with the Commander/CO to ensure all aspects of risk is applied and that adequate sun protection/sun screen is made available, and is applied accordingly.

Blue Service cap

3.85 The Blue Service cap has a coloured band and black patent leather peak. The band is scarlet for all ranks and all Corps, except chaplains who wear purple cap-bands. The peak of the cap worn by a field officer has a band of gold embroidery 2 cm wide at the lower edge. For a Colonel (COL) or Brigadier (BRIG), the peak has a row of gold oak leaf embroidery and for a General officer the peak has two rows of gold oak leaf embroidery. A patent leather chinstrap is attached by two line 20 buttons. The Blue Service cap is worn by Senior officers, those special appointments, IAW [Chapter 1](#).

3.86 The Regimental Sergeant Major – Officer Training College, and selected Army personnel at Australian Defence Force Academy (ADFA) as well as Drill Instructors at RMC are to wear the Blue Service cap while participating in some ceremonial parades or as directed by the COMDT.

3.87 The Blue Service cap is worn level on the head, with the centre of the peak above the bridge of the nose. The correct method of wearing a Blue Service cap is in Figure 3–19. Cap badges are to be positioned, IAW [Chapter 4](#).

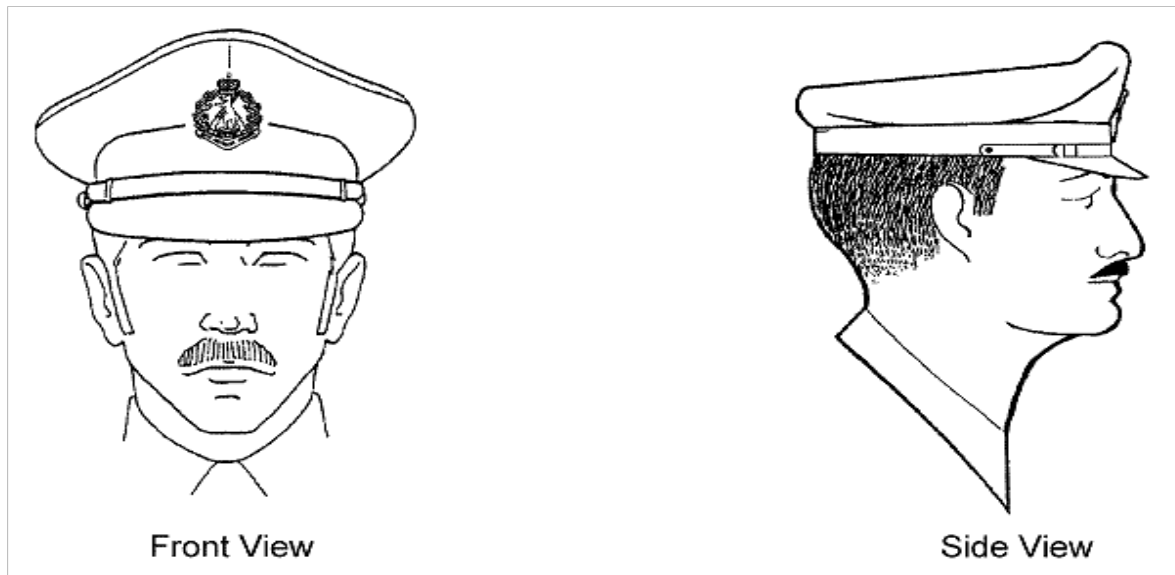
Figure 3-19: Wearing the Blue Service Cap**Field hat**

3.88 The field hat is worn with Field Dress (AMCU) and Combat Dress (AMCU). The field hat is not to be worn in public or the barracks environment as a substitute for other forms of barracks headdress, unless participating in field training related activities. The issued field hat must have a 6 cm brim and is not to be cut, shortened or amended in way to improve its appearance. The issued field hat may be worn with cordage and locking plunger. An 'after-market' shortened brim version of the field hat with metal vents, cordage and locking plunger may be worn in lieu of the issued field hat but is purchased at the members' expense from the Army Shop. The 'after-market' shortened brim version of the field hat must have at least a minimum 4 cm brim and is not to be cut, shortened or amended in way to improve its appearance.

3.89 AMCU Field Cap is worn in the Field Dress (AMCU) Dress Order No 4B Field Dress and Combat Dress (AMCU) Dress Order No 4C, 5A,5B and 9. The AMCU Field Cap is not to be worn in public or the barracks environment as a substitute for other forms of barracks headdress, unless participating in field training related activities. The AMCU field cap maybe may be worn by TS personnel and aircrews when servicing aircraft on the flight line (It is not to be worn outside of the flight line when not in the field environment). The AMCU Field Cap may be worn by Ships Army Establishment when at sea or working alongside ships in port. The AMCU Field Cap is not to be worn outside the docks. The Velcro on the front is for the placement of the low vis ANF only no unit patches are to be worn on the AMCU Field Cap.

3.90 The current issued Black Field Cap been issued for current domestic operations may continue to be worn as directed by JTF 629 for those working in the field and on tasking until stocks are depleted and the AMCU field cap is issued to the member. The Black Field Cap may be worn by members of the AABC when performing music tasks, whilst dressed in AMCU, where the situation or equipment used precludes other forms of headdress The field cap in domestic operations is only to be worn by those operating in the field or on task, all HQ personnel are to continue to wear the headdress of the Australian Army been the Hat Khaki Fur Felt.

Figure 3-20: AMCU Field Cap



Figure 3-21: Black Field Cap



3.91 The United Nations Blue and Multi-National Forces and Observers Terracotta may be worn by those supporting UN mission and the MFO when a field cap is issued.

Turbans

3.92 Turbans may be worn by members of the Sikh religion who have been granted exemption from the cutting of hair. The colour of the turban worn with all orders of dress is to be black or tan to mid brown in colour. The material used is to be the standard currently worn by a Sikh religious member. The provision of turbans for Sikh members is a member's responsibility. The wearing of Sikh religion items and accoutrements are in [Chapter 2](#).

Jibab or Hijab

3.93 Headdress for cultural and religious reasons is a valid item of dress and is currently provided at the member's expense. These items of dress are not to be worn in a way that conceals the identity of the person wearing it but may conceal all hair, ears and throat. The majority of the face forward of the ears, to the top of the neck below the chin and above the eyes is to be exposed. The head covering material is to be tucked neatly inside the collar of the uniform.

3.94 A program is underway to design and procure this item of dress, of varying colours and designs which will be issued to members. Paragraph 3.87 is to be followed until the new item has been released.

IDENTIFICATION DISCS

3.95 Identification discs or 'dog tags' in Figure 3-22 are to be worn when engaged in field training or operations, duty travel in Service aircraft or when posted overseas. They are to be worn only around the neck, using the issued chain only.

Figure 3-22: Identification disc (hexagonal type) with necklace identification tag



IDENTIFICATION ARM PATCHES

3.96 When necessary, identification arm patches of the approved design are worn to identify the wearer. They may be worn on the right sleeve on the velcro patch. The CO is to direct unit policy on whether the identification arm patch is worn in place of the USP. Only one patch is to be worn on the right sleeve. The Red Cross (Geneva Convention requirements) patch is to be worn on a brassard under the ANF National Distinguishing Sign on the left sleeve of AMCU shirts. Identification arm patches are not to be sewn onto the sleeves of AMCU shirts. The designs are in Figure 3-23. They are described in Table 3-5.

3.97 Other designs of identification arm patches, such as Garrison MP, Battalion Orderly SGT, Duty Student, etc may be used within local unit areas, but are not authorised designs for general use outside those unit areas. The patch size is to be IAW Table 3-5 serial 1.

Figure 3-23: Designs of identification arm patches



a. Training Establishment - Army



b. Movement Control Personnel



c. Regimental Police



d. ADF Investigative Service



e. RACMP Personnel



f. RACMP Personnel Low Visibility



g. Personnel protected by the Geneva Convention

Table 3-5: Designs of identification arm patches

| Serial | Worn by | Description | Remarks |
|--------|---|--|--|
| 1 | Instructors and administrative officers of schools authorised by FORCOMD | Two horizontal bands coloured green over yellow with a Recruit or Military Instructor Badge positioned centrally | Badge rectangular 7.5 cm x 5.5 cm |
| 2 | Movement control personnel | An eight-spoked yellow wheel on a red background | Badge rectangular 7.5 cm x 5.5 cm |
| 3 | Regimental Police | The scarlet letters 'RP' on a black background | Badge rectangular 7.5 cm x 5.5 cm |
| 4 | RACMP personnel posted on strength to the ADFIS | The black 25 mm high letters 'ADFIS' on a light orange brown background | Badge rectangular 7.5 cm x 5.5 cm |
| 5 | RACMP personnel | The black 40 mm high letters 'MP' on a scarlet background | Badge rectangular 7.5 cm x 5.5 cm |
| | RACMP low visibility patch for field training, exercise and operations only | The black 40 mm high letters 'MP' on a drab green background | Badge rectangular 7.5 cm x 5.5 cm |
| 6 | Personnel protected under the Geneva Convention as follows: a. medical personnel b. chaplains c. members of the Red Cross, or other relief societies d. stretcher bearers and ancillary medical personnel | A red cross on a white background | Cross 8 cm high Only to be worn while participating in field related activities or on operations Worn on a brassard on the left sleeve of AMCU |

JACKETS

Australian Multi-cam Camouflage Uniform General Purpose Jacket

3.98 The AMCU General Purpose (GP) Jacket is worn with AMCU orders of dress and working/protective orders of dress. An AMCU rank slide is to be worn by all ranks.

Garrison jacket

3.99 The khaki brown Garrison jacket in Figure 3-24, is a medium weight jacket with a zipper. The jacket is an optional item which may be purchased at the members' expense. The Garrison jacket is not to be worn with AMCU. This jacket does not replace the Utility jacket. The Garrison jacket is not to be worn on unit parades or any activity of a ceremonial nature. When worn the zipper of the jacket it

is to be zipped up as a minimum to a position equivalent to the top of the breast pockets. The jacket is not to be worn as of 31 Dec 2023.

3.100 The Garrison jacket provides the wearer with protection from adverse environmental elements for short periods of time. Some examples of when the jacket may be worn are:

- a. travel on public transport from home location to an office environment
- b. travel within Australia using air transportation while on approved duty
- c. from office environment to office environment within a garrison area, such as a barracks or military area, ie Puckapunyal Military Area or Russell Offices
- d. to buy and consume a meal at a local shop.

3.101 The Garrison jacket should be removed when the wearer has entered the office environment; however, at the discretion of the commander or CO the jacket may be worn in that environment should the heating be inadequate.

3.102 The Garrison jacket is embellished with the Australian Army Rising Sun Badge. The khaki brown rank slide is to be worn. No other embellishments are to be worn with the Garrison jacket. The Sam Browne Belt is not worn with the Garrison jacket.

Figure 3-24: Garrison jacket



Leather motorcycle jacket

3.103 Leather motorcycle jackets are worn as protective dress by members of RACMP, Royal Australian Corps of Transport and Royal Australian Corps of Signals while engaged in motorcycle duties and other personnel authorised to perform motorcycle duties. The jackets are not to be embellished and may be worn when conducting motorcycle escort duties on ceremonial parade escort in cold climates.

Utility jacket

3.104 The khaki polyester utility jacket in Figure 3–25 and 3–26, is an optional item which may be purchased at the members' expense and worn with general duty orders of dress. It is only to be worn with a polyester shirt long sleeve and khaki polyester tie.

3.105 The jacket is embellished with the Australian Army Rising Sun Badge, trade and military skills badges, badges of rank, embroidered rank slides for officers, metal 'AUSTRALIA' shoulder titles for ORs, lanyard, nameplate, ribbons, badges, emblems of unit and individual awards, and Army Individual Readiness Notification (AIRN) Badge. The provisions for the wearing of these embellishments are in [Chapter 4](#) and [Chapter 6](#). The Utility jacket may be removed when the wearer has entered the office environment. When worn, the Utility jacket is to be fastened (buttoned) to the top at all times. The Sam Browne Belt is not worn with the Utility jacket.

Figure 3-25: Utility jacket – left side



Figure 3-26: Utility jacket – right side



Service dress jacket

3.106 The Service dress jacket is only to be worn in conjunction with Service dress trousers or Service dress skirt and is only worn when wearing service dress orders of dress, IAW [Chapter 5](#). The Service dress jacket is issued to the following regions, groups or positions:

- a. Tasmania
- b. Victoria
- c. New South Wales
- d. South Australia
- e. Western Australia
- f. Australian Capital Territory
- g. Senior Leadership Group
- h. Aide-de-camp
- i. Regimental Sergeant Major
- j. Non-Operational overseas position.

3.107 The jacket is embellished with the Australian Army Rising Sun Badge, trade and military skills badges, badges of rank, metal 'AUSTRALIA' shoulder titles, lanyard, nameplate (when not on parade), ribbons of orders, decorations, medals, badges, emblems of unit and individual awards, and AIRN Badge. The provisions for the wearing of these embellishments are in [Chapter 4](#) and [Chapter 6](#). The Service dress jacket may be removed when the wearer has entered the office environment. When worn, the Service dress jacket is to be 'buttoned up' at all times. The Sam Browne Belt, ceremonial belt, waist belt 32mm or Colour belt is to be worn, IAW paragraph 3.13–3.17.

LANCES

3.108 Lances are carried when ordered by WOs, NCOs and ORs posted to a RAAC unit during RAAC parades.

3.109 The lance is to be no more than 2.77 m in length, measured from the bottom of the shoe to the tip of the head, and the weight is to be between 2.0 and 2.6 kg. The stave of the lance can be made of Black Ash or Bamboo and is tapered from a diameter of 3.7 cm at the shoe to 2.7 cm at the point where the stave is joined to the head.

3.110 The grip/sling of the lance is to be made of black leather and is positioned so that it is central to the balance point of the lance, which should be approximately 1.17 m from the shoe. The grip/sling is to be no more than 33 cm in length.

3.111 The RAAC unit pennant is attached to the stave of the lance immediately below the head.

LANYARDS

3.112 A lanyard is to be worn on the polyester shirt, Service Dress jacket and Utility jacket by all members up to and including Lieutenant Colonel (LTCOL) rank. COL and BRIG serving in a Corps appointment are to wear their Corps lanyard, RSM–A, Tier C RSM appointments and other members not allocated to a Corps are not to wear a lanyard. Lanyards are worn with Ceremonial Dress and General Duty (polyesters). Lanyards are not worn with Mess Dress, Patrol Blue orders of dress, AMCU, Field or Protective Dress, overcoat or raincoat.

3.113 The lanyard is worn around the shoulder, passing under the epaulette and under the arm, with the ball of the loop to the rear and with the loose end, which terminates with the larger loop, passing beneath the breast pocket button and secured on the inside of the pocket. The method of knotting and wearing the lanyard is, IAW Figure 3–27 (right shoulder) and Figure 3–28 (left shoulder). The shoulder on which the lanyard is worn and the lanyard colours are in Table 3–6.

3.114 Non-Royal Australian Corps of Infantry (RA Inf) personnel who are posted to Australian Regular Army or Army Reserve infantry units are to wear the authorised regimental lanyard of that unit in lieu of their parent Corps lanyard, but retain all other parent Corps embellishments, including headdress and Corps badges, where applicable, except for members of a Corps based sub-unit within a unit are to wear the lanyard of their parent Corps applicable to that sub-unit, eg 2/10 Light Battery, RAA within 5/6 Royal Victorian Regiment are to wear the parent Corps (white)

lanyard on the right shoulder. RA Inf personnel posted to non-Corps positions are to replace unit lanyards with the RA Inf scarlet lanyard.

Figure 3-27: Method of knotting and wearing the lanyard (right shoulder)

RIGHT SHOULDER

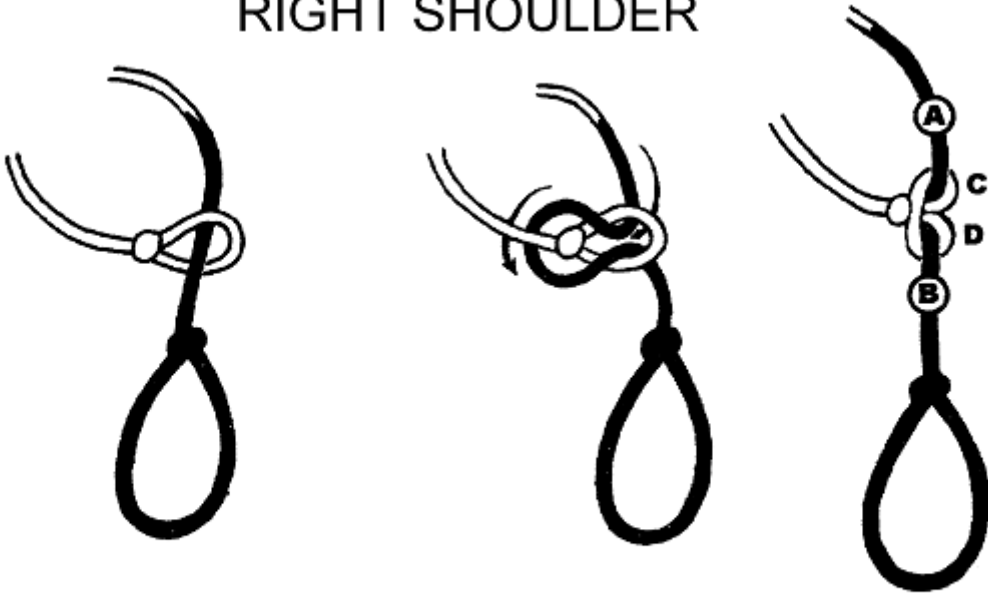

Note: The lanyard section A-B is pulled straight and the sections C and D are pressed together and stitched with a cotton which matches the colour of the lanyard.

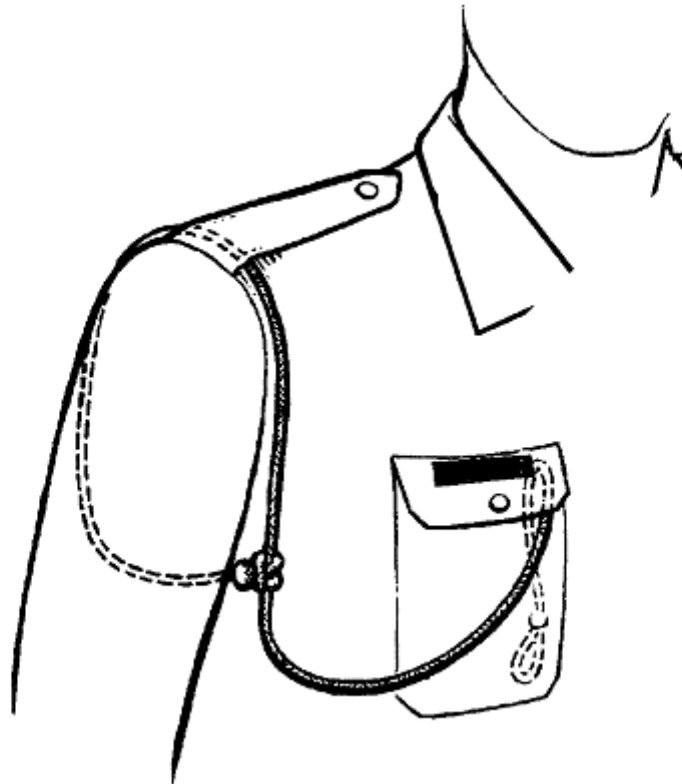

Figure 3-28: Method of knotting and wearing the lanyard (left shoulder)

LEFT SHOULDER



Note: The lanyard section A-B is pulled straight and the sections C and D are pressed together and stitched with a cotton which matches the colour of the lanyard.

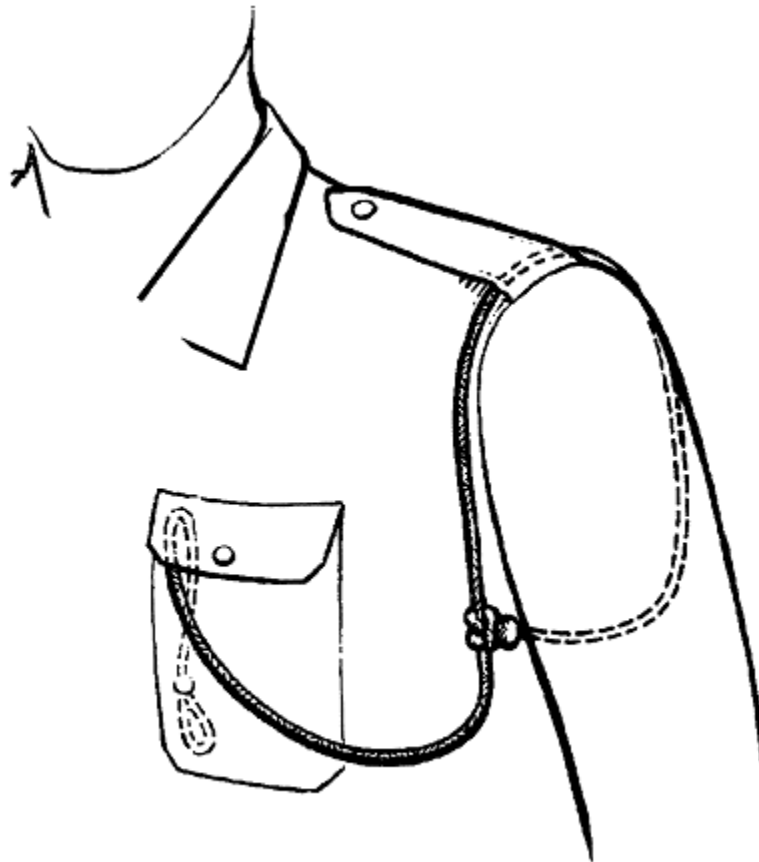

Table 3-6: Lanyard colours

| Serial | Corps or Unit | Colour | Shoulder | Remarks |
|----------------------|--|------------------------|----------|-----------------|
| 1 | Corps of Staff Cadets (the Sovereign's Company) | Scarlet | Right | |
| 2 | Corps of Staff Cadets (except the Sovereign's Company) | Khaki | Right | |
| 3 | RAAC | Yellow | Right | |
| 4 | RAA (except 'A' Bty, RAA) | White | Right | |
| 5 | 'A' Bty, RAA | White | Left | |
| 6 | RAE | Blue-black | Right | |
| 7 | RA Sigs | Royal blue | Right | |
| 8 | RA Inf | Scarlet | Right | |
| 9 | The Royal Australian Regiment (RAR) | | | |
| | a. 1 RAR | Garter blue | Left | |
| | b. 2 RAR | Black | Left | |
| | c. 3 RAR | Rifle green | Left | |
| | d. 5 RAR | Gold | Left | |
| | e. 6 RAR | Khaki | Left | |
| | f. 7 RAR | Maroon | Left | |
| | g. 8/9 RAR | Slate grey/beech brown | Left | Braided lanyard |
| h. Depot Company RAR | Scarlet | Left | | |
| 10 | SASR | Garter blue | Left | |
| 11 | 1 Cdo Regt | Garter blue | Left | |
| 12 | 2 Cdo Regt | Garter blue | Left | |
| 13 | SOER | Garter blue | Right | |
| 14 | Royal Queensland Regiment (RQR) | | | |
| | a. 9 RQR | Garter blue | Left | |
| | b. 25/49 RQR | Scarlet/khaki | Left | Braided lanyard |
| | c. 31/42 RQR | Black/gold | Left | Braided lanyard |
| 15 | 51 FNQR | Rifle green | Left | |

| Serial | Corps or Unit | Colour | Shoulder | Remarks |
|--------|--|------------------------------|----------|-----------------|
| 16 | Royal New South Wales Regiment (RNSWR) | | | |
| | a. 2/17 RNSWR | Black/gold | Left | Braided lanyard |
| | b. 4/3 RNSWR | Scarlet/rifle green | Left | Braided lanyard |
| | c. 1/19 RNSWR | Garter blue/slate | Left | Braided lanyard |
| | d. 41 RNSWR | Khaki | Left | |
| 17 | Royal Victoria Regiment (RVR) | | | |
| | a. 5/6 RVR | Gold/khaki | Left | Braided lanyard |
| | b. 8/7 RVR | Brown/white | Left | Braided lanyard |
| 18 | Royal South Australia Regiment (RSAR) a. 10/27 RSAR | Garter blue/black | Left | Braided lanyard |
| 19 | Royal Western Australia Regiment (RWAR) | | | |
| | a. 11/28 RWAR | Garter blue/rifle green | Left | Braided lanyard |
| | b. 16 RWAR | Black | Left | |
| 20 | Royal Tasmania Regiment (RTR) a. 12/40 RTR | Garter blue/black | Left | Braided lanyard |
| 21 | North West Mobile Force (NORFORCE) | Bottle green/spectrum orange | Left | Braided lanyard |
| 22 | Pilbara Regiment | Burnt orange | Left | |
| 23 | Queensland University Regiment | Slate grey | Left | |
| 24 | Sydney University Regiment | Black | Left | |
| 25 | University of New South Wales Regiment | Maroon | Left | |
| 26 | Melbourne University Regiment | Rifle green | Left | |
| 27 | Deakin University Company | Yellow/garter blue | Left | Braided lanyard |
| 28 | Adelaide Universities Regiment | Khaki | Left | |
| 29 | Western Australian University Regiment | Scarlet | Left | |
| 30 | Regional University Regiments of Queensland | Scarlet | Left | |

| Serial | Corps or Unit | Colour | Shoulder | Remarks |
|---------------|--|---------------------|-----------------|-----------------|
| 31 | Australian Army Aviation | Light blue | Right | |
| 32 | Australian Intelligence Corps | Bottle green | Right | |
| 33 | Royal Australian Army Chaplains Department | Purple | Right | |
| 34 | Royal Australian Corps of Transport | Scarlet/dark blue | Right | Braided lanyard |
| 35 | Royal Australian Army Medical Corps | Dull cherry | Right | |
| 36 | Royal Australian Army Dental Corps | Burnt orange | Right | |
| 37 | Royal Australian Army Ordnance Corps | Scarlet | Right | |
| 38 | Royal Australian Electrical and Mechanical Engineers | Dark blue | Right | |
| 39 | Royal Australian Army Educational Corps | Pale blue | Right | |
| 40 | Australian Army Public Relations Service | Bottle green/gold | Right | Braided lanyard |
| 41 | Australian Army Catering Corps | Slate grey | Right | |
| 42 | Royal Australian Army Pay Corps | Gold | Right | |
| 43 | Australian Army Legal Corps | Maroon | Right | |
| 44 | Royal Australian Corps Military Police | Scarlet/black | Right | Braided lanyard |
| 45 | Australian Army Psychology Corps | Maroon | Right | |
| 46 | Australian Army Band Corps | Scarlet/rifle green | Right | Braided lanyard |
| 47 | Royal Australian Army Nursing Corps | Scarlet/slate grey | Right | Braided lanyard |
| 48 | ARes Officer Cadet Training Unit (senior class) | Scarlet | Right | |
| 49 | ARes Officer Cadet Training Unit (junior classes) | Khaki | Right | |
| 50 | Army component Australia's Federation Guard | Bottle green/gold | Left | Braided lanyard |

LEGAL DRESS

3.115 A legal robe may be worn over the Australian Army uniform by a member qualified to wear the robe when carrying out the duties of that office. Headdress is not worn when wearing the robe.

MOURNER'S BAND OR BRASSARDS

3.116 Mourner's band or brassards are of black crepe or material, 8 cm wide, and are worn on the left arm, midway between the elbow and the shoulder. Mourner's band or brassards are to be worn when at military funerals and when repatriating soldiers' remains to Australia at the point of disembarkation. The Brassard NSN is: 8455-66-163-4866.

3.117 Mourner's band or brassards are only to be worn by the following personnel:

- a. the Army's Official Mourner
- b. the mourning party
- c. the complete bearer party
- d. the chaplain
- e. all personnel in command appointments of respective party elements
- f. all ushers and door orderlies
- g. the gun carriage driver
- h. the Music Director or Bandmaster and Drum Major
- i. all officers and WO1
- j. all liaison and escort/host officers
- k. the Master Ceremonies, drummer and piper during repatriation ceremonies
- l. buglers, when not part of a band.

3.118 They are to be worn by officers, when ordered, during periods when the Court is in mourning. Except when the Court is in mourning, they are not to be worn at levees. They are not to be worn at ceremonies, such as the unveiling of memorials or ANZAC Day and Remembrance Day services.

3.119 A member in private mourning may wear a mourner's band or brassard with ceremonial or general duty orders of dress, when not on parade and with the approval of the member's commander or CO. The mourner's band or brassard may be worn from the death until the day of the funeral. Mourner's band or brassards may be worn with AMCU when on operations outside of Australia. Mourner's band or brassards are held in each major military area, training establishment, Bde RSMs and State Joint Operations Support Staff Ceremonial RSMs.

NAMEPLATES

3.120 An authorised nameplate is to be worn on jackets and shirts with General Duty (polyesters), Ceremonial Dress and Officer’s Ward Dress White. A nameplate is not worn with Ceremonial Parade Dress when on ceremonial parades, except for General and Senior officers, ADCs and Equerries. A nameplate is not worn with Mess Dress, AMCU, Garrison jacket, AMCU General Purpose jacket, wet weather jacket or ORs Ward Dress White.

3.121 Authorised Australian Army nameplates are black over white plastic, 2 cm wide by 7.5 cm long, with the Australian Army Rising Sun Badge on the extreme right of the nameplate, IAW Figure 3-29. Lettering is engraved in white in upper and lower case, with upper case letters 6 mm high and lower case letters 4 mm high. Nameplates are to show the given name and surname. Christian names may be abbreviated, but no nicknames are to be used. The individuals rank is not to be engraved onto the nameplate. The nameplate is worn centrally on the flap of the right breast pocket with the top of the plate 5 mm below the upper edge of the pocket flap, as shown in Figure 3-30.

3.122 HQ FORCOMD, HQ 1 Div, HQ 2 Div, SOCOMD, Army recruiting staff, RMC, ADFA, HQ ADF, Defence or Joint Service Establishments and Defence Force Recruiting may wear the distinctive nameplate of those organisations during posting. On posting from those organisations to another Army unit, the standard Australian Army nameplate is to be worn. Army members posted to an overseas representative position may wear a nameplate which includes their name in English and or the appropriate language in white on a black background.

Figure 3-29: Nameplate specifications



Figure 3-30: Wearing the nameplate

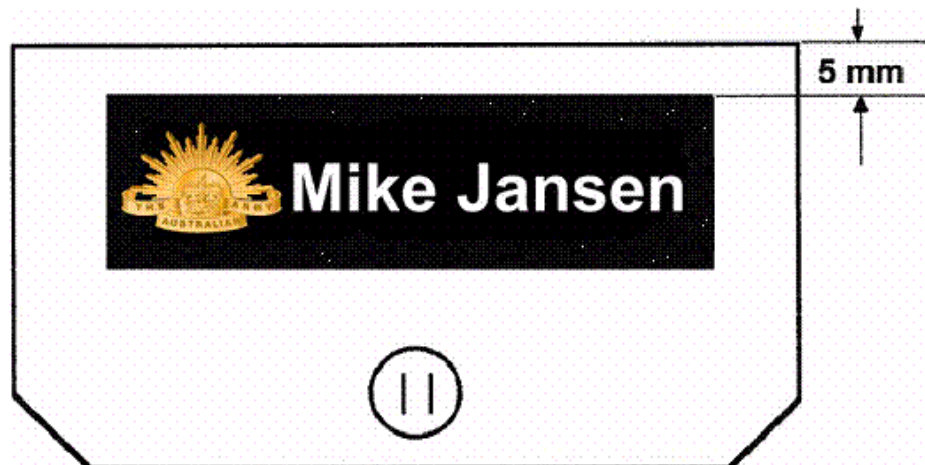

NAME TAGS

3.123 A name tag, with embroidered black uppercase characters 15 mm high, on the appropriate background is to be worn on AMCU shirts, the AMCU GP Jacket and Protective Dress. A name tag, with embroidered red characters 15 mm high, on a white background is to be worn on all appropriate physical training instructor attire; white background with 15 mm high, black characters are worn with Cooks Dress and ORs Ward Dress White. The specifications for name tags are in Figure 3-31. Names are not to be embroidered directly onto shirts.

Figure 3-31: Name tag specifications

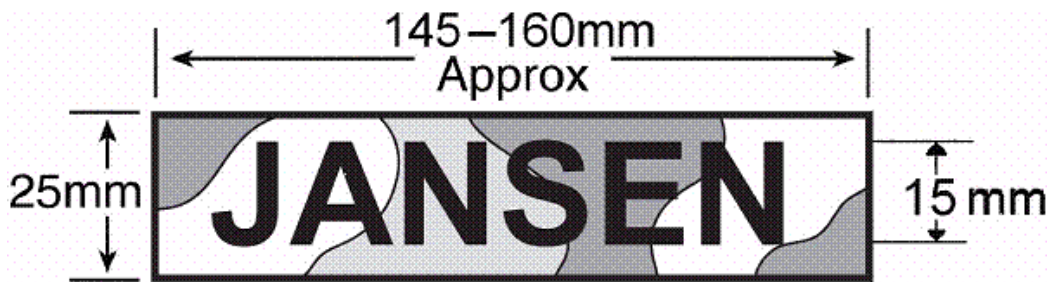

3.124 Name tags are sewn onto shirts, centrally above the right pocket with the lower edge of the name tag immediately above the pocket seam, as shown in Figure 3-32.

Figure 3-32: Wearing the name tag

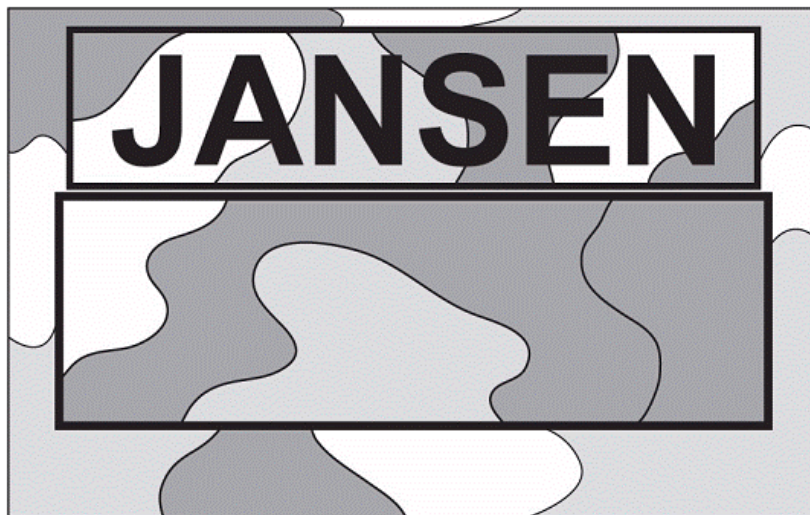

NECKTIE

Necktie khaki polyester

3.125 A khaki polyester necktie is worn with Ceremonial Service Dress, and General Duty Service Dress and when the Utility jacket is worn with General Duty (polyesters). The knot is to be tied as a Windsor knot, IAW Figure 3-33 to Figure 3-36. The khaki polyester tie mounted on elastic bands may also be worn.

Tiepin/clip

3.126 When the long sleeve polyester shirt is worn with a tie in an office environment, a tiepin or tie clip may be worn. The pin or clip is to be worn 2/3rds below the tie knot. The design and colour of the pin or clip is to be of conservative style representing the Unit, Corps or Service.

3.127 The pin or clip is not to be visible when a jacket is worn. These items are not to be worn with ceremonial or parade orders of dress. These items are not provided at Commonwealth expense.

3.128 Black bow tie. A black bow tie is worn with all mess dress orders of dress, IAW [Annex 5O](#).

ORDERS, DECORATIONS AND MEDALS

3.129 Except for neck decorations, members who have been presented and are entitled to wear decorations, ribbon bars and medals are to wear them above the left hand breast pocket. Medals are to be court-mounted. Decorations and medals are worn with ceremonial orders of dress.

3.130 Authorised unofficial medals, eg Royal Humane Society awards are worn on the right side. Miniature orders, decorations and medals are worn with Mess Dress, IAW [Annex 5O](#). The Australian Order of Precedence, wearing and the method of mounting medals are in [Chapter 6](#).

3.131 Ribbons of unofficial awards are worn in the same location on the right side. Ribbons are worn with general duty orders of dress. Ribbons are not worn on AMCU, Garrison jacket, AMCU General Purpose Jacket, raincoat, overcoat or any orders of Protective Dress.

Figure 3-33: Tying the Windsor knot (steps 1 and 2)

THIS IS A MIRROR IMAGE DIAGRAM

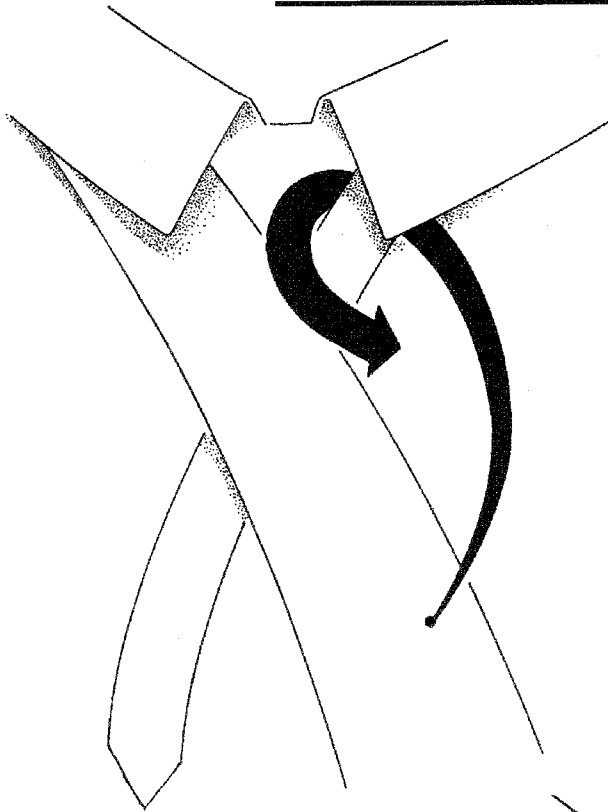

Step 1

Place the tie around the neck with the Wider Side (End) on the left of the body, (this is the longer of the two ends); place the wider end across and over the narrow end.

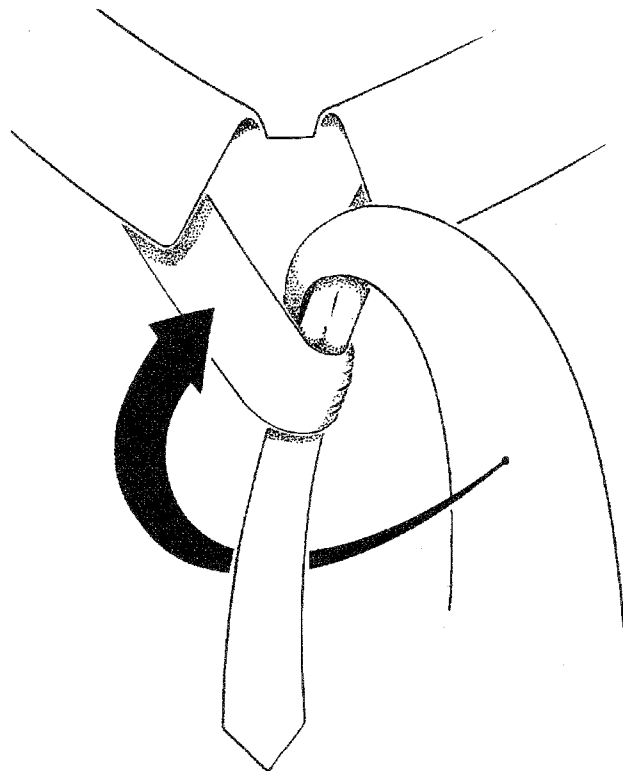

Step 2

Bring the wider end up, under and over the narrow end.

Figure 3-34: Tying the Windsor knot (steps 3 and 4)

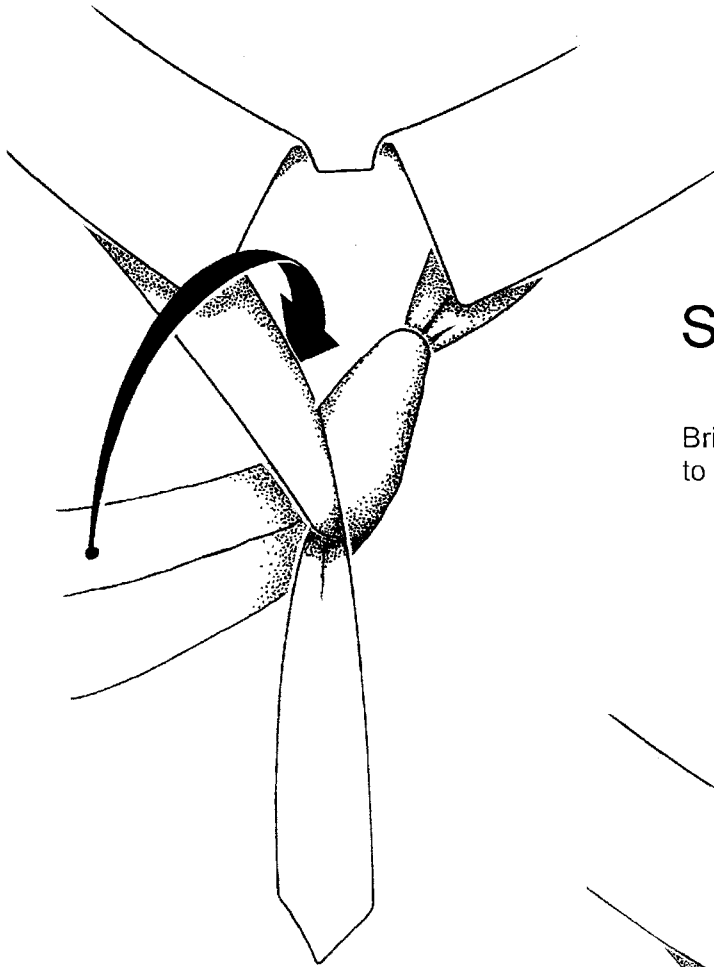

Step 3

Bring the wide end under and across to the left side of the body.

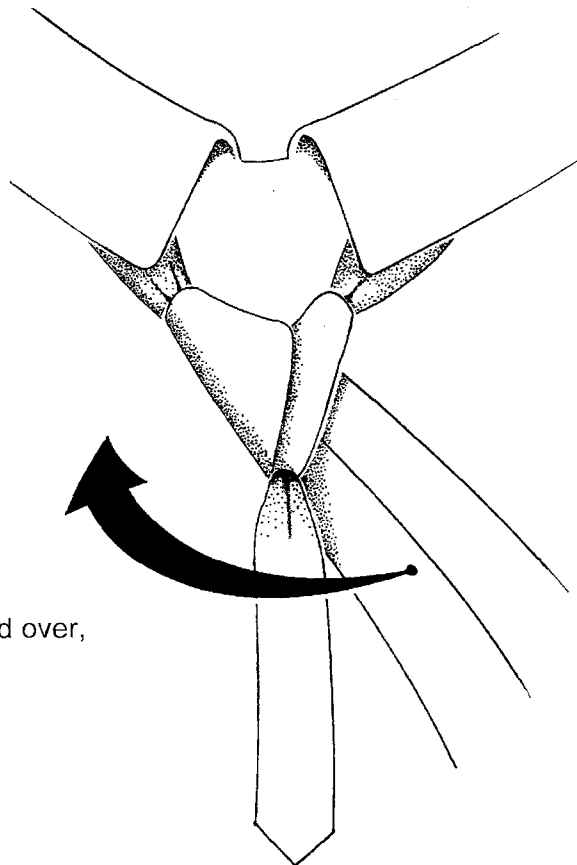

Step 4

Bring the wide end up and over, back through the loop.

Figure 3-35: Tying the Windsor knot (steps 5 and 6)

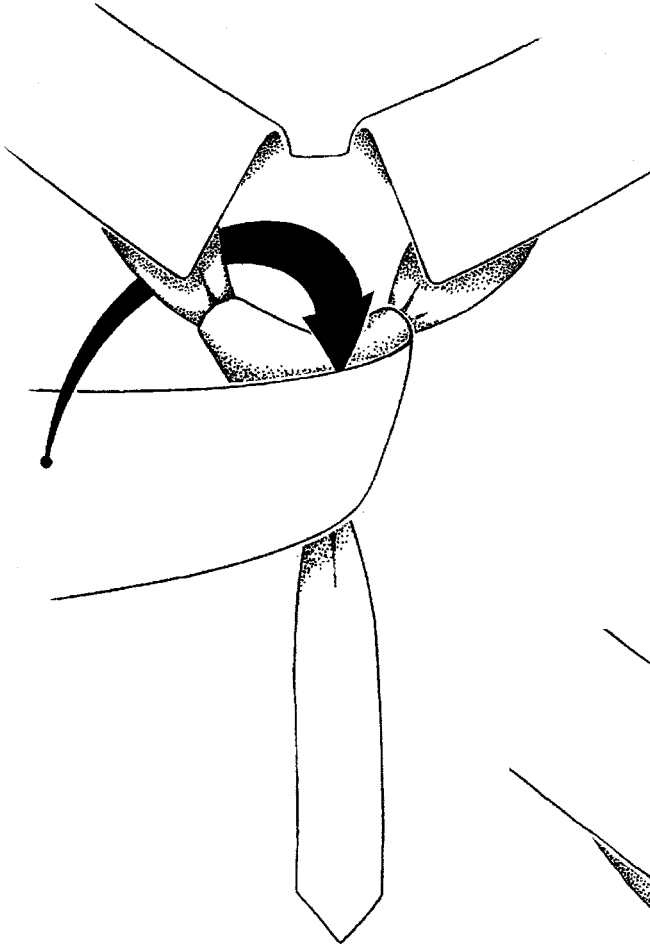

Step 5

Bring the wide end around and across from the right, over the front of the forming knot.

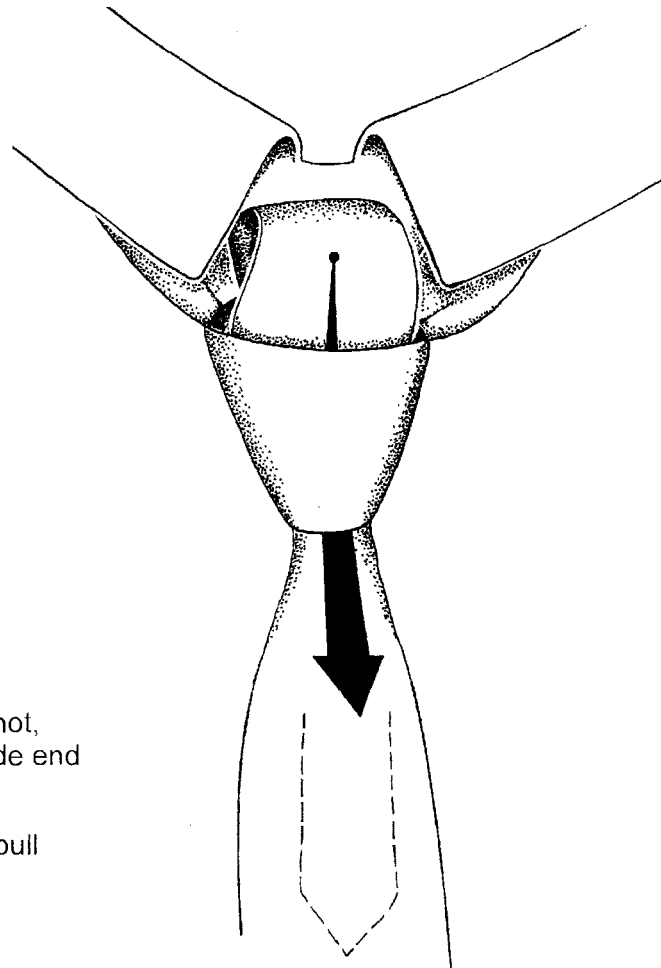

Step 6

Bring the wide end behind the knot, up through the loop; feed the wide end down through the tie.

Pull the wide end down, then pull the tie up to the neck.

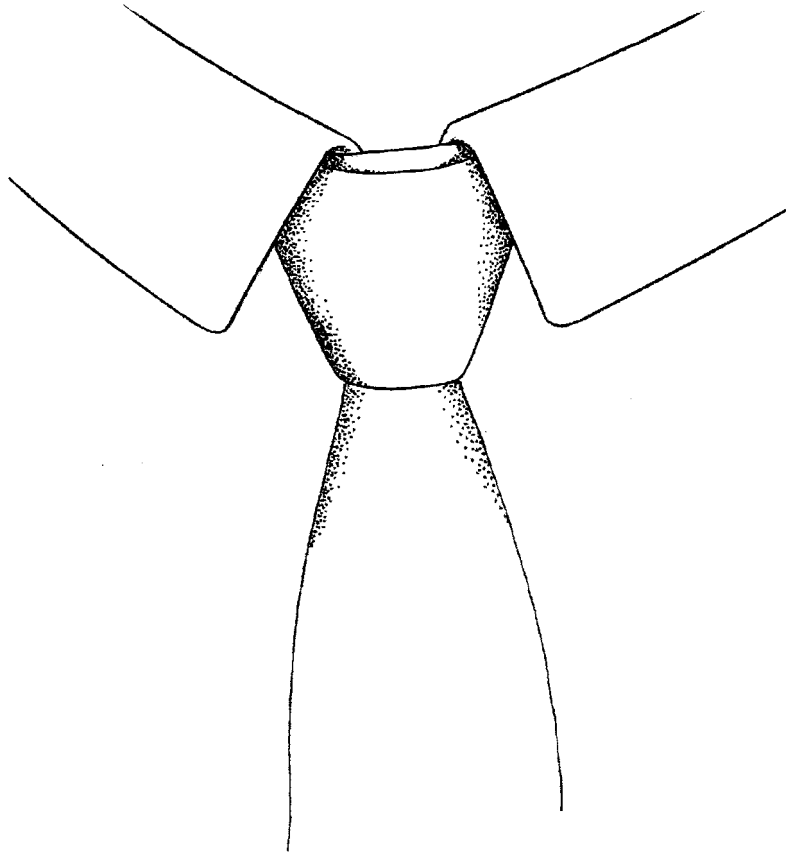
Figure 3-36: Tying the Windsor knot (the final knot)

The Final Knot

OVERCOATS

Overcoat extreme cold weather

3.132 The approved pattern overcoat extreme cold weather may only be worn by those specific members posted to overseas positions on representational duties or attending ceremonial activities and the Army component of the AFG. The overcoat is issued with a cloth waist strap for wearing with the garment. The embellishments to be worn on the overcoat are insignia rank, 'AUSTRALIA' shoulder titles, collar badges, medals, citation(s) and Army Combat Badge (ACB) / Infantry Combat Badge (ICB). A white belt is to be worn when on parade during ceremonial activities. The overcoat is to be buttoned to breast pocket height, as shown in Figure 3-37. The overcoat is not worn with a black belt or Sam Browne Belt but may be worn with or without dark brown leather gloves.

Figure 3-37: Overcoat extreme cold weather**Overcoat lightweight**

3.133 The approved pattern overcoat lightweight may be worn by all members when wearing general duty and ceremonial orders of dress, but not with Ceremonial Parade Dress. The overcoat is not to be embellished, including wearing badges of rank. The overcoat is to be buttoned to breast pocket height and is worn with a waist belt which is to be done up.

PACE STICKS

3.134 Pace sticks are to be carried at all times when wearing ceremonial and general duty orders of dress, by a qualified RSM, posted to an RSM appointment, the Guard Sergeant Major of the AFG and those in [paragraph 3.138](#). A pace stick is not carried when wearing a sword with leather scabbard. Whilst deployed on operations a pace stick is only to be carried when performing ceremonial tasks or duties.

3.135 Pace sticks are to be of polished brown or natural timber colour and fitted with brass fittings. Pace sticks that are carried for ceremonial or appointment purposes are to be plain in nature, in one colour, except the traditional Maori carved pace stick 'Taonga' in paragraph 3.132 and with no other affixed items. Those qualified RAAC, AA Avn and RAANC RSM appointed to a Tier A and B positions, are to carry black pace sticks with silver/chrome fittings.

3.136 RSM'S within the Regional Force Surveillance Group may carry a decorated Pace Sticks. The Decorated Pace Stick is to remain unique to the units within the RSFG only and only to be carried on ceremonial events and parades. The decorated Pace Stick is to reflect the Nation's First people of that region the unit is based within. The history and meaning to the NORFORCE - indigenous artwork on the pace stick are in [Annex 3E](#)

3.137 Pace stick drill is in [LWP-G 7-7-5-Drill](#).

3.138 Pace sticks of distinctive design are authorised to be carried by RSM-A, Regimental Master Gunner RAA (Corps RSM), Combined Arms Training Centre and the Master Gunner Joint Fires, HQ 6 Bde. The traditional Maori carved pace stick 'Taonga' may only be carried by selected RA Inf WOs, Tier A and Tier B RSMs who meet the following criteria:

- a. The member has successfully completed a posting tenure as a RA Inf WO2 exchange instructor at the New Zealand Officer Cadet School.
- b. The member has been officially presented with a traditional Maori carved pace stick by a member of the New Zealand Army at the conclusion of the posting tenure.
- c. The member has been promoted to WO1 and appointed as a RSM.
- d. The member is posted into a RSM appointment and meets the criteria in paragraph 3.134.

3.139 The following personnel may carry pace sticks for instructional and training purposes:

- a. Drill instructors at RMC, only to be carried within the confines of RMC.
- b. Instructors and students on the RSM course.

3.140 Qualified members appointed as Corps RSM and not in an RSM appointment are to carry pace sticks at all times when performing Corps related tasks. Those members who are not qualified RSM and are carrying out the Corps WO role, are not to carry pace sticks. Members who are temporarily filling the role of RSM or have been posted into an RSM appointment, but have not qualified on an RSM course, are not to carry a pace stick until the qualification is gained. However, when a member is RSM course qualified and filling the role of RSM or has been appointed into an RSM appointment, he/she may carry the pace stick providing the person meets the following criteria:

- a. The member is authorised by a unit Routine Order which is signed only by the unit CO.

ADM

3–55

- b. The member is excluded from all other duties or appointments that were previously held.
- c. The member must only be performing the duties of a unit RSM.
- d. The member is scheduled to perform the duties of a unit RSM for a minimum period of four months.

PANTHOSE, STOCKINGS AND FOOTLETS FOR FEMALES

3.141 Pantihose or stockings are optional with General Duty Dress (polyesters); and ceremonial orders of dress. If they are not worn with General Duty Dress (polyesters) or ceremonial orders of dress, footlets are to be worn with the issued footwear. Pantihose, stockings and footlets must be plain and in matching flesh tones, when worn with ceremonial and general duty orders of dress. Stockings or pantihose when worn with Mess Dress is to be plain black.

PARACHUTIST SMOCK

3.142 The parachutist (para) smock is only to be worn by parachute qualified members within a parachuting unit, in barracks and during parachuting activities. The para smock may be worn by any Army member when in the field, during a range practice and on operations. When worn, the para smock is to be buttoned and zipped-up to breast pocket height at all times. The para smock is to be issued temporarily to unit members and withdrawn on march-out. When worn in barracks, the para smock is embellished with an AMCU nametag, rank insignia, Australian Army Rising Sun Badge and the appropriate qualified parachutist badge which is to be sewn on the right sleeve of the garment.

3.143 The units entitled to wear the para smock in barracks are as follows:

- a. SASR
- b. 1 Cdo Regt
- c. 2 Cdo Regt
- d. SOER
- e. SOLS
- f. PTS
- g. 176 AD Sqn.

RAINCOATS

3.144 No embellishments are worn on the raincoat. When worn in barracks or in public, the raincoat is to be buttoned to breast pocket height. The raincoat may be worn unbuttoned in the field or on operations. The raincoat is not to be worn with ceremonial or general duty (polyesters) orders of dress.

SASHES

Ceremonial waist sash

3.145 The gold and crimson or crimson ceremonial waist sash is worn by Senior officers and special appointments, IAW [Chapter 1](#). The gold and crimson or crimson ceremonial waist sash is worn with Patrol Blue orders of dress. The rifle green waist sash is worn by AABC officers posted to the RMC Band. The rifle green ceremonial waist sash is worn with the AABC ceremonial uniform, ie BC1-No 1 AABC Ceremonial Dress (RMC-D) with White or Blue Jacket and Blue Service cap. The ceremonial waist sash is worn with the tassels on the left side.

Scarlet shoulder sash

3.146 When ordered, a scarlet shoulder sash is to be worn on ceremonial parades, barrack guard duties and at regimental, mess or unit functions when ceremonial or mess dress orders of dress are to be worn. The scarlet shoulder sash is worn by:

- a. a RA Inf WO2 and SNCO
- b. an authorised member of the Corps of Staff Cadets or OCDT.

3.147 The scarlet shoulder sash is worn diagonally over the right shoulder under the shirt epaulette with the tassels hanging from the left side. The front is worn under the belt and the rear is worn over the belt.

3.148 The scarlet shoulder sash is worn outside the jacket with Patrol Blue orders of dress and Service Dress jacket. With Mess Dress, it is worn under the jacket and the front of the sash is worn under the cummerbund.

SHIRTS

Khaki polyester shirt

3.149 The khaki polyester shirt is worn with ceremonial and general duty orders of dress.

3.150 A short sleeved shirt is to be worn with the collar button undone and the collar ironed flat, IAW [Chapter 2](#). Singlets, T-Shirts and other forms of underclothing may be worn but are not to show at the neck or below the ends of the sleeves. The long sleeve shirt is to be worn with the sleeves down and buttoned, the collar buttoned and neck tie worn.

3.151 The finished length of the sleeve of the short sleeved khaki polyester shirt is to be, IAW Table 3-7. The sleeve is to have a 2 cm hem which is included in this measurement.

Table 3-7: Short sleeved khaki polyester shirt sleeve length

| Shirt size | Length from centre crown at shoulder to sleeve end – unfinished | Length from centre crown at shoulder to sleeve end – finished | Length of underarm sleeve – unfinished | Length of underarm sleeve – finished |
|------------|---|---|--|--------------------------------------|
| 36 cm | 28 cm | 24 cm | 17 cm | 13 cm |
| 37 cm | 28 cm | 24 cm | 17 cm | 13 cm |
| 38 cm | 28.5 cm | 24.5 cm | 17 cm | 13 cm |
| 39 cm | 28.5 cm | 24.5 cm | 17 cm | 13 cm |
| 40 cm | 29 cm | 25 cm | 17.5 cm | 13.5 cm |
| 41 cm | 29 cm | 25 cm | 17.5 cm | 13.5 cm |
| 42 cm | 29.5 cm | 25.5 cm | 17.5 cm | 13.5 cm |
| 43 cm | 29.5 cm | 25.5 cm | 17.5 cm | 13.5 cm |
| 44 cm | 30 cm | 26 cm | 18 cm | 14 cm |
| 45 cm | 30 cm | 26 cm | 18 cm | 14 cm |

Australian Multi-cam Camouflage Uniform shirt

3.152 The AMCU shirt is worn as Field Dress (AMCU) and General Duty Dress (AMCU), IAW [Chapter 2](#). The AMCU shirt sleeves are not to be cut-off, folded or rolled-up, IAW [Chapter 1](#). An issued green T-Shirt, Army logo green T-Shirt or a prescribed coloured T-shirt, IAW paragraph 3.205 is authorised to be worn under AMCU shirts, and is to be tucked in at all times.

3.153 Mess Dress shirt. The Mess Dress shirt is worn with mess dress orders of dress, IAW [Annex 5O](#).

SHOULDER BOARDS

3.154 Khaki detachable shoulder boards are worn in pairs by officers, OCDTs and SCDTs with the khaki shirt when wearing Ceremonial Dress and Ceremonial Parade Dress. Shoulder boards are worn with metal badges of rank. Metal ‘AUSTRALIA’ shoulder titles are to be pinned to the board and worn by Senior and General officers; and Corps/Regiment shoulder titles are to be worn by officers LTCOL rank and below.

SHOULDER CORDS

3.155 Shoulder cords are worn with patrol blue orders of ceremonial dress by entitled officers. Officers entitled to wear shoulder cords are those authorised to wear ceremonial equipment, IAW [Chapter 1](#) and officers of the AABC.

3.156 Entitled RAAC, AA Avn or RAANC officers are to wear silver shoulder cords. Other entitled officers wear gold shoulder cords. The backing of shoulder cords is scarlet, except RAANC are grey.

3.157 General officer shoulder cords are of plaited gold wire basket cord 5 mm in diameter and small gold gimp down the centre. The strap of the cord is 57 mm wide, terminating in a 105 mm wing.

3.158 Other shoulder cords are 40 mm wide and are made of twisted gold or silver basket cord 5 mm in diameter.

3.159 Shoulder cords are worn in pairs. They are to be long enough to overhang the shoulder seam by 1 cm. Rank insignia with prongs are worn on shoulder cords. Gold insignia are worn on silver cords and silver insignia are worn on gold cords. The positioning of rank insignia on the left and right shoulder cord is in Figure 3-38. All officer rank insignia is positioned centrally on the shoulder cord with 5 mm spacing between each rank insignia. 'AUSTRALIA' shoulder titles and Corps shoulder titles are not to be worn on shoulder cords.

Figure 3-38: Positioning rank insignia on shoulder cords on the left and right shoulder – Lieutenant to Major General

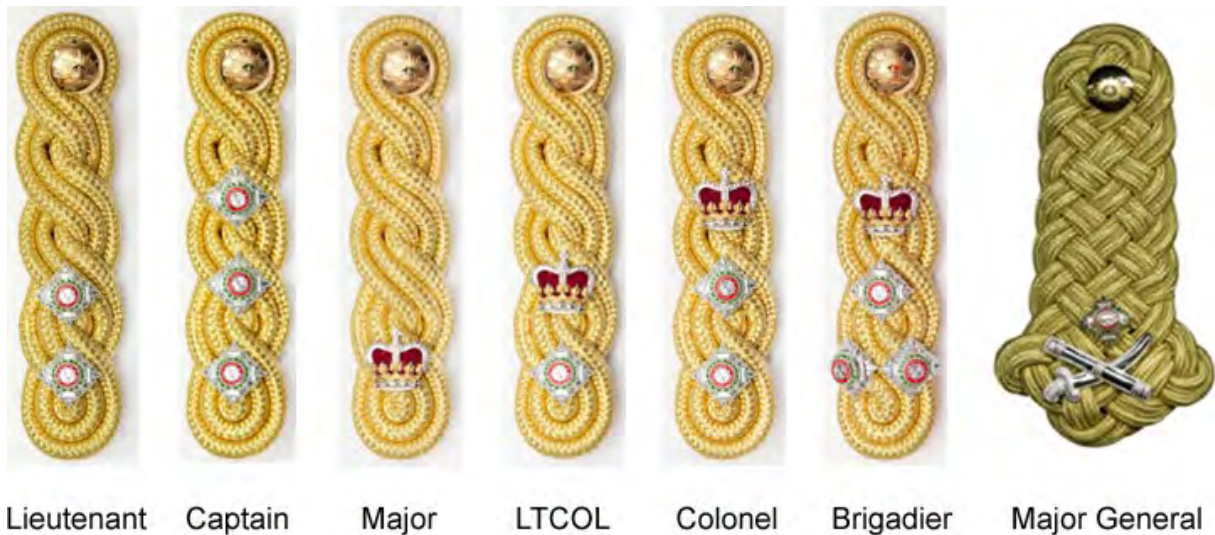

SHOULDER PATCHES

Field Shoulder Patch

3.160 Only an authorised Field Shoulder Patch (FSP) may be worn on the velcro patch on the right sleeve of the AMCU shirt. The FSP is worn only with Field Dress (AMCU) uniform, when participating in field related training activities or during field exercises. The FSP may be worn in the field during exercises overseas, but not on operations. The FSP may be worn in barracks, but only when Field Dress (AMCU) uniform is worn for field related training activities. The FSP is not to be worn in the barracks environment when General Duty Dress (AMCU) uniform are worn and it does not to replace the Unit Shoulder Patch (USP) when this order of dress is worn. The FSP is not to be sewn onto the sleeves of the AMCU shirt.

3.161 The FSP design is to be approved by the commander or unit CO and oversight for the design is to be the Bde or Formation RSM. The command oversight is to be AHQ; however, functional commands, ie HQ FORCOMD, HQ SOCOMD and HQ 1 Div are responsible to manage their respective FSP registers.

3.162 The FSP design may be a subdued version of the USP or an independent low visibility design that meets the Army's values.

3.163 The design, provision and maintenance of the FSP are at the unit's expense, by using only non-public monies, eg Regimental Trust Funds. Commonwealth monies are not to be used in any circumstance.

3.164 The wearing of the FSP is not mandatory, but units that authorise a FSP are to apply consistency within its sub-units. Sub-units FSP within a unit are not authorised to be designed or worn.

Operational shoulder patch

3.165 Only an authorised Operational Shoulder Patch (OSP) may be worn. The OSP is worn with Field Dress (AMCU) whilst deployed on operations outside of Australia. The OSP is not to be worn in barracks. Only one patch is to be worn on the right sleeve of the AMCU shirt. The OSP is not to be sewn onto the sleeves of the AMCU shirt.

3.166 OSPs for Force Elements (FE) deploying are requested through the Mounting HQ and approved by HQ Joint Operations Command (JOC) in the same manner as a USP. OSP for FE deploying on operations are funded from operational sustainment funding and procured for either an FE, eg MTF or an entire operation, Op ANODE or Op ASTUTE. OSP that contain the following will not be approved:

- a. rotation numbers
- b. unit specific references, mascots, etc.

3.167 Approved OSP are to be procured, catalogued, and added to Block Scale 3004-08. This will ensure that the patch is procured in sufficient quantity to kit multiple rotations with additional held for sustainment stock. Maintenance of the OSP once approved is a unit responsibility. The manufacturers will need to be provided with the design specification by the unit. Once approved and manufactured, units are to provide one OSP with coloured design and authorised colour codes to DGAPC for quality control and a one OSP to the Army History Unit (AHU) for central historical collection.

Unit shoulder patch

3.168 USP differs from identification arm patches. Only an authorised USP may be worn. The USP is worn in barracks, with General Duty Dress (AMCU) on the velcro patch on the right sleeve of the AMCU shirt. The USP is not to be worn on operations or field exercises. Only one patch is to be worn on the right sleeve of the AMCU shirt. USP are not to be sewn onto the sleeve of the AMCU shirt. All USP approved for wear by Army personnel are at the [Unit Shoulder Patch Register](http://www.army.gov.au/Our-work/Equipment-and-clothing/Army-Dress-Manual/Unit-Shoulder-Patch-Register)¹¹.

¹¹ <http://www.army.gov.au/Our-work/Equipment-and-clothing/Army-Dress-Manual/Unit-Shoulder-Patch-Register>

3.169 The request and administrative procedure for the USP is in [Annex 3C](#).

SHOULDER SLIDES

3.170 Shoulder slides with 'AUSTRALIA' titles and badges of rank embroidered in gold, silver or black on khaki background are worn in pairs on the following garments:

- a. polyester shirt with general duty order
- b. Utility jacket
- c. maternity uniform
- d. polyester shirt worn in an office environment, when the jacket is removed.

3.171 With RAAMC, RAADC and RAANC white Working Dress; shoulder slides are worn as follows:

- a. RAAMC—dull cherry slide, ORs plain, officer rank embroidered in gold
- b. RAADC—burnt orange slide, ORs plain, officer rank embroidered in gold
- c. RAANC—scarlet slide, ORs plain, officer rank embroidered in silver.

SHOULDER TITLES

'AUSTRALIA' shoulder titles

3.172 The 'AUSTRALIA' shoulder titles, in [Figure 3–39](#) are worn in pairs and are produced in gold, that are worn by Senior and General officers and the wider Army; chrome/silver, that are worn only by RAAC, AA Avn and RAANC; and black anodised metal, that are worn only by 51 FNQR and SUR members. 'AUSTRALIA' shoulder titles are worn when wearing particular orders of dress. 'AUSTRALIA' shoulder titles are not worn on shoulder cords, IAW paragraph 3.153. The wearing of metal 'AUSTRALIA' shoulder titles applies to the following:

- a. Senior and General officers when wearing ceremonial orders of dress, service dress orders of dress, mess dress orders of dress and Ceremonial Safari Suit. With General Duty Dress (polyesters) and the Utility jacket, Senior and General officers are to wear embroidered shoulder slides incorporating the embroidered rank and 'AUSTRALIA' title, IAW paragraph 3.164.
- b. All other officers LTCOL rank and below when wearing service dress orders of dress and mess dress orders of dress. With General Duty Dress (polyesters) and the Utility jacket, all other officers, LTCOL rank and below are to wear embroidered shoulder slides incorporating the embroidered rank and 'AUSTRALIA' title, IAW paragraph 3.164. However, the metal 'AUSTRALIA' shoulder titles are not worn by all other officers, LTCOL rank and below when wearing Dress Order No 2A, 2B, 2C and 2D, IAW paragraph 3.168(a).

ADM

3-61

- c. RSM-A and all Tier C RSMs who are holding a Tier C RSM appointment when wearing all orders of dress, except when wearing AMCU.
- d. All other WOs, NCOs and ORs when wearing service dress orders of dress, mess dress orders of dress and the Utility jacket.
- e. RSM-A and all WO1 when wearing mess dress orders of dress.
- f. All WO2 rank members and below when wearing Mess Dress White Jacket. All WO2 and SNCOs are to wear embroidered shoulder slides incorporating the embroidered 'AUSTRALIA' title on the Mess Dress Army jacket, IAW [Annex 5O](#).
- g. The Army component of the AFG and officers on national representational duties, eg Equerry to the Queen or when posted to Australian embassies.
- h. By all personnel with Patrol Blue orders of dress when not wearing shoulder cords.
- i. All Army personnel and contingents are to wear 'AUSTRALIA' shoulder titles in lieu of Corps and Regiment shoulder titles, when representing the Australian Army or ADF on duties outside of Australia. In exceptional circumstances requests to wear Corps or Regiment shoulder titles outside of Australia can be sought from DGAPC.

Figure 3-39: Gold and black 'AUSTRALIA' shoulder titles



Corps shoulder titles

3.173 Corps shoulder titles are worn in pairs and are produced in gold and chrome/silver that are worn by RAAC, AA Avn and RAANC members. Corps

shoulder titles are to be worn by LTCOL rank members and below when wearing particular orders of dress. Corps shoulder titles are not worn on shoulder cords, IAW paragraph 3.153. An example of Corps Shoulder Titles (RAA) is in Figure 3-40. The wearing of Corps shoulder titles applies to the following:

- a. All officers, LTCOL rank and below when wearing Dress Order No 2A, 2B, 2C and 2D.
- b. All Tier C RSMs who are no longer holding a Tier C RSM appointment.
- c. All Tier B appointed WO1 rank members and below when wearing Dress Order No 2A, 2B, 2C, 2D, 2E, 2F, and 8.

Regiment shoulder titles

3.174 Regiment shoulder titles are worn in pairs and are produced in gold; chrome/silver that are worn only by RAAC and AA Avn members; and black anodised metal that are worn only by 51 FNQR and SUR members. Regiment shoulder titles are to be worn by LTCOL rank members and below when wearing particular orders of dress. Regiment shoulder titles are not worn on shoulder cords, IAW paragraph 3.153. An example of Regiment Shoulder Titles (2 Cav Regt) is in Figure 3-38. The wearing of metal Regiment shoulder titles applies to the following:

- a. All officers, LTCOL rank and below who are posted to a unit with specific Regiment/Unit badges and shoulder titles when wearing Dress Order No 2A, 2B, 2C and 2D.
- b. All Tier A appointed WO1 rank members and below who are posted to a unit with specific Regiment/Unit badges and shoulder titles when wearing Dress Order No 2A, 2B, 2C, 2D, 2E, 2F and 8.

Figure 3-40: An example of Corps and Regiment shoulder titles



3.175 'AUSTRALIA'/Corps/Regiment shoulder titles are worn on the epaulette or shoulder board with the lowest point of the badge, 5 mm from the outer end of the strap, board or epaulette, IAW Figure 3-41.

Figure 3-41: Positioning 'AUSTRALIA' shoulder titles



SIGNS

National Distinguishing Sign

3.176 The National Distinguishing Sign is an embroidered insignia in the form of the ANF with the word 'AUSTRALIA' below. This insignia is in Figure 3-40 and Figure 3-41.

Figure 3-42: High visibility sign distinguishing-Australian National Flag



AMCU

3.177 The high visibility sign distinguishing-ANF is worn in barracks by all personnel wearing General Duty Dress (AMCU). The high visibility sign is worn on the velcro patch on the left sleeve under the Australian Army Rising Sun Badge. The Red Cross (Geneva Convention requirements) patch is the exception and is to be worn on a brassard under the national distinguishing sign on the left sleeve, IAW paragraph 3.96. The high visibility sign distinguishing-ANF and Red Cross are not to be sewn onto the left sleeve of the AMCU shirt, IAW paragraph 3.96.

3.178 The low visibility sign distinguishing-ANF is worn in the field or on operations by all personnel with Field Dress (AMCU) and Combat Dress (AMCU). It is worn on the velcro patch on the left sleeve under the Australian Army Rising Sun Badge. The Red Cross (Geneva Convention requirements) patch is the exception and is to be worn on a brassard under the national distinguishing sign on the left sleeve, IAW paragraph 3.96. The low visibility sign distinguishing-ANF and Red Cross are not to be sewn onto the left sleeve of the AMCU shirt, IAW paragraph 3.96.

Figure 3-43: Low visibility sign distinguishing-Australian National Flag



AMCU

3.179 The UN and MFO badge is worn by personnel posted to UN and MFO deployments. It is worn sewn on the right sleeve of the shirt khaki polyester or on the velcro patch on the AMCU shirt. Any requirement by individual operations/deployments in relation to the wearing of distinguishing patches is to be requested through DGAPC for consideration and approval.

SKIRTS

3.180 Skirts may be worn by females with ceremonial and general duty orders of dress but not with ceremonial orders of parade dress, ie Dress Order No 1A, 2A and 2B. Skirts blue/black are to be worn with mess dress orders of dress, IAW [Annex 5O](#). Slacks blue/black may be worn by females with mess dress orders of dress, as a substitute to wearing the Skirt blue/black.

Length of skirts

3.181 The bottom edge of khaki polyester skirts is to be no higher than 2.5 cm above, or lower than 4 cm below the top of the kneecap. The bottom edge of the blue/black skirt is to touch the toe of the shoe.

ZIP POLO THERMAL

3.182 The issued zip polo thermal as shown in Figure 3-44 may be worn with General Duty Dress (AMCU) and Field Dress (AMCU). When worn with Field Dress, the following is to be applied:

- a. if visible, zip polo thermal must be fully zipped/buttoned and the neck rolled down neatly and evenly
- b. if worn unzipped, the zip polo thermal collar is to be folded back and worn flat beneath the AMCU or protective shirt collar.

Figure 3-44: Zip Polo Thermal



SOCKS

3.183 The issue khaki brown socks are to be worn with all orders of dress which include khaki brown polyester trousers or AMCU trousers. Lightweight khaki brown socks may be worn in lieu of woollen socks in orders of dress other than Ceremonial Parade Dress Order No 1A, 1B, 2A, 2B, 2C and 2D.

3.184 Black socks are worn when blue/black trousers are worn by personnel wearing Mess Dress and white Protective Dress.

3.185 Socks are to have a wrinkle-free appearance when worn. Socks which are seamed or knitted in ribbed pattern are to have the seams or patterns straight up the length of the sock. Socks, worn with bloused AMCU or Protective Dress trousers, are not to be visible.

3.186 Socks and stockings worn with Scottish Dress are in [Annex 5E](#).

SUNGLASSES

3.187 Sunglasses may be worn whilst wearing the Australian Army uniform as follows:

- a. Prescribed tinted or photochromatic spectacles may be worn at any time, IAW the prescription. The requirement for the frames of prescribed tinted spectacles is the same as for prescribed spectacles. Only black coloured lenses are permitted, sunglasses that have brightly coloured or reflective coated lenses are not permitted.

- b. Non-prescribed sunglasses may be worn when eye protection is necessary in other than ceremonial orders of dress. Sunglasses, either issued or purchased by individuals, are to conform to the design requirements for prescribed spectacles except that wrap-around or side panels are permitted. Only black coloured lenses are permitted, sunglasses that have brightly coloured or reflective coated lenses are not permitted.
- c. Sunglasses are to be worn covering the eyes only. They are not to be worn, dangled or suspended from other parts of the body, uniform or on top of the head.

Prescribed spectacles

3.188 Frames of prescribed spectacles are to be metal in gold, silver or bronze finish; or plastic in black or brown tones. Black or brown neck straps for spectacles of cord type (not chin), may be worn.

SWORDS

3.189 The four types of sword authorised are:

- a. the General officers sword (Mameluke)—worn by General officers
- b. the Cavalry sabre—worn with black leather and silver fittings by members of the RAAC and AA Avn
- c. the Artillery sword—worn by members of RAA
- d. the Infantry sword—worn by members of the RA Inf and all other members and ex-members entitled to wear a sword, RAANC have a black leather scabbard fitted with a black leather Infantry sword knot.

3.190 Members of RAA Ch D are not to wear swords and sword accessories.

General officers, Senior officers and special appointments

3.191 Details of sword equipment and accessories worn by Senior officers and officers holding special appointments are in [Annex 5B](#) and [Annex 5C](#).

Officers and Warrant Officer Class One

3.192 When swords are to be worn by officers and WO1, the following items are to be worn except as otherwise stated:

- a. Sam Browne Belt
- b. sabre/sword with leather scabbard
- c. leather sword knot
- d. leather sword frog.

- e. An RSM does not carry a pace stick when wearing this sword; however, a pace stick is carried when wearing white slung equipment.

Ensigns of Flag, Colour Parties, Regimental Sergeant Major and Drum Major

3.193 The ensigns of Flag, Colour Parties, RSM and Drum Major are to wear the following equipment on ceremonial parades:

- a. Infantry/Artillery sword, as applicable
- b. steel Infantry/Artillery scabbard, as applicable
- c. white leather sword knot
- d. white sword belt with slung equipment
- e. white gloves (Drum Major wear gauntlets)

3.194 Alternatively, ensigns may wear the equipment at paragraph 3.186.

Assembly of sword equipment (suspended)

3.195 When a suspended sword is worn with Ceremonial Patrol Blue orders of dress, a webbing waist belt is worn under the jacket to carry the weight of the sword. The method of assembling and wearing the equipment is in Figure 3-43, Figure 3-44 and Figure 3-45. The assembly instructions are as follows:

- a. **Waist belt with shoulder suspender.** The waist belt is worn outside the overalls and under the jacket. The shoulder suspender is worn over the right shoulder and should be adjusted to withstand the weight of the sword, as shown in Figure 3-45.

Figure 3-45: Assembly of sword equipment (suspended)

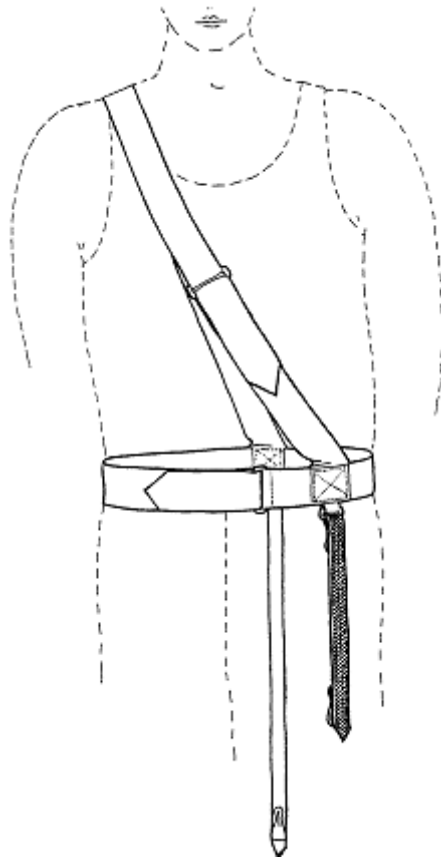

- b. **Sword slings.** The leather slings faced with gold lace are provided in sets, one short and one long. The front (short) sling is fastened with the square end on the brass 'D' at the left hip on the waist belt and the pointed end is fastened to the upper ring of the sword scabbard. The rear (long) sling is fastened with the square end on the brass 'D' at the rear of the waist belt and the pointed end is fastened to the lower ring of the sword scabbard. The long sling emerges from below the centre rear of the jacket. When the sword scabbard is removed, the slings may be left attached to the waist belt and the loose ends fastened together, as shown in Figure 3-46.

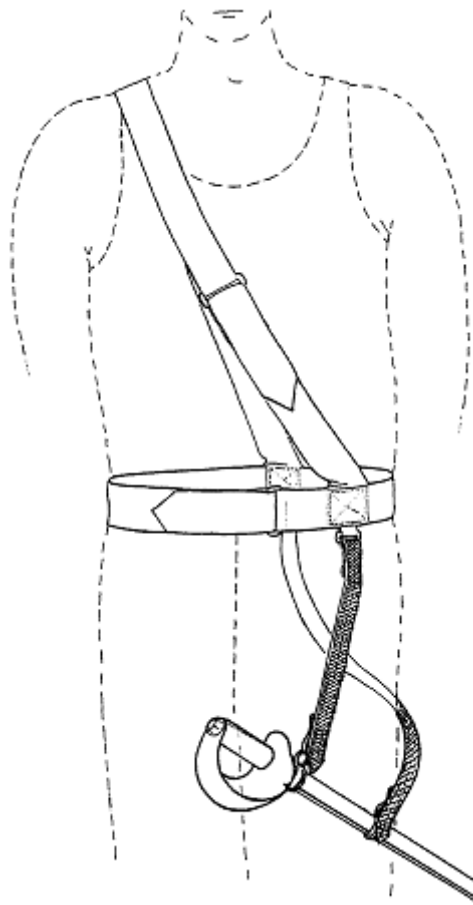
Figure 3-46: Wearing sword equipment (suspended)

- c. **Sword knot with acorn.** To tie the knot and position the acorn, pass the double end through the metal eye in the pommel of the sword from the inside, while the sword is held in the correct position. Then pass the acorn through the loop formed on the outside and pull the acorn down to the full extent of the sword knot. Slide the runner up the double cords as high as possible and then fashion the sword knot into a figure of eight. The upper bight of the figure of eight is then passed over the knob on the front tang (crossbar) of the hilt to prevent undue movement. The acorn hangs below the tang, as shown in Figure 3-47 and Figure 3-48.

Figure 3-47: Sword knot—Mameluke sword

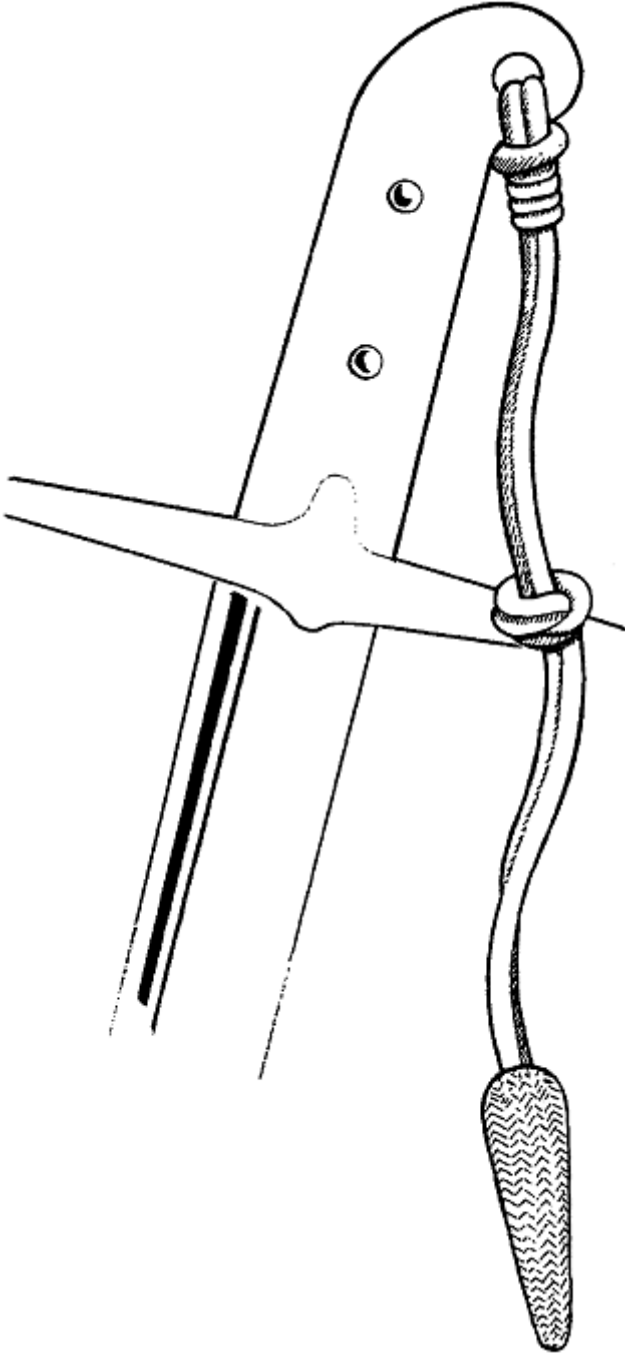

Figure 3-48: Sword knot—Mameluke sword



- d. **Waist sash with tassels.** The sash is worn outside the jacket and fastened at the left hip. The tassels hang on the left side, to the rear of the short sling and reach about 10 cm below the skirt of the coat.
- e. **Carriage of suspended sword and scabbard.**
- (1) **Mameluke sword.** The sword is carried by the hilt in the left hand. The shoe of the scabbard trails to the rear, just above the ground.
 - (2) **Cavalry sabre, Infantry and Artillery swords.** The sword is carried in the left hand, which is positioned between the base of the hilt and the first metal D on the scabbard IAW Figure 3-49. The shoe of the scabbard trails to the front, just above the ground IAW Figure 3-50.

Figure 3-49: Positioning of left hand-suspended equipment

TBA

Figure 3-50: Carriage of sword-suspended equipment

TBA

Assembly of sword equipment (slung)

3.196 The components of the white slung sword equipment are in Figure 3-51.

3.197 To assemble the sword equipment (slung):

ADM

3-73

- a. lay out the belt with the outside uppermost and with the hook and 'D' pointing down
- b. attach the fold-over end of the short strap to 'D'
- c. attach the fold-over end of the long strap around the centre of the belt
- d. with the rings of the scabbard pointing left, attach the scabbard to the belt by placing the upper ring over the belt hook
- e. the unattached end of the short strap is passed under and around the scabbard and the fold-over tab attached to the upper ring of the scabbard
- f. the unattached end of the long strap is passed over the scabbard and the fold-over tab attached to the lower ring of the scabbard
- g. the sword is placed in the scabbard with the hilt to the rear.

3.198 A metal device designed to support or maintain sword equipment in the correct position may be used. Chains and other visible adornments are not to be used.

Figure 3-51: Components of sword equipment (slung)

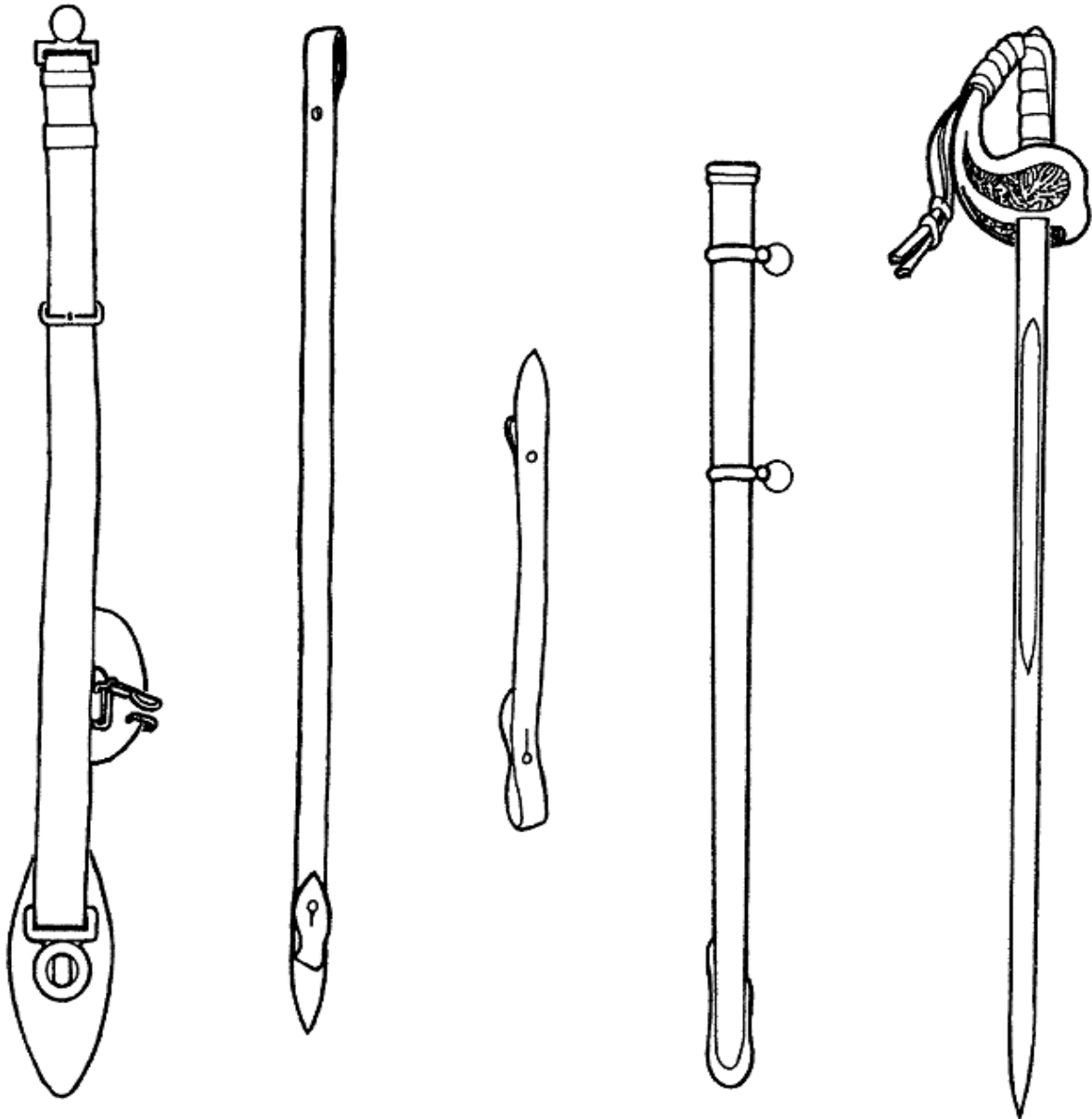

3.199 The slung sword is assembled, as shown in Figure 3-50 and worn, IAW Figure 3-52.

Figure 3-52: Assembling of sword equipment (slung)

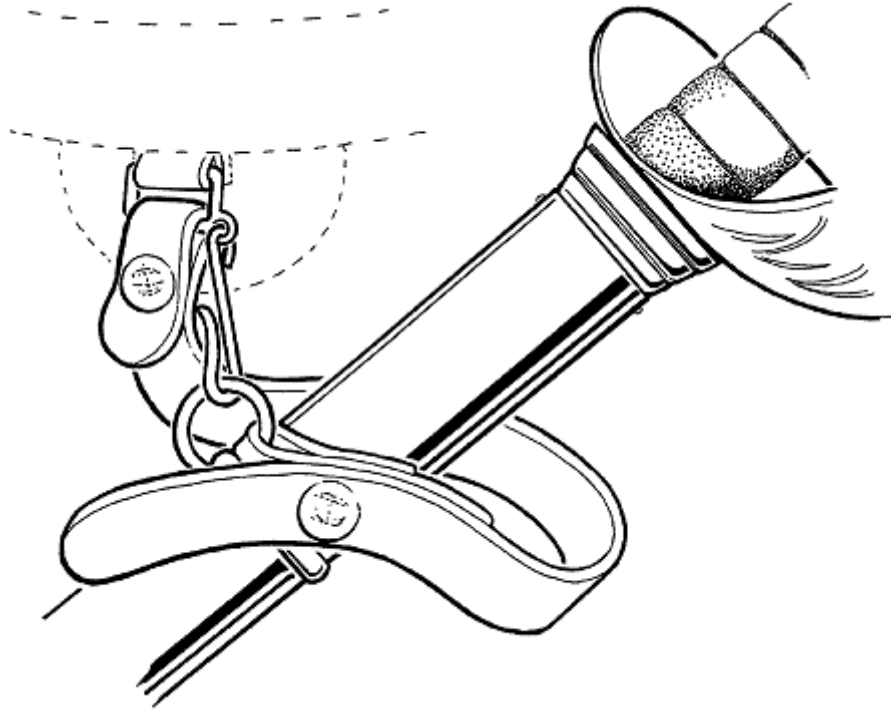
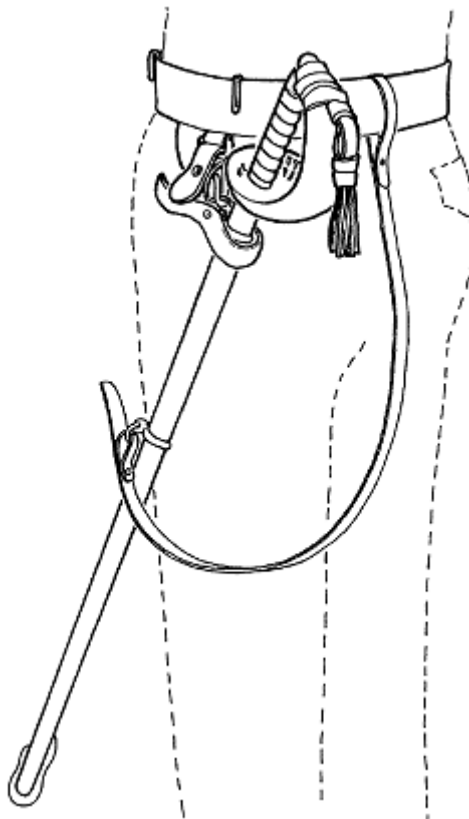

Figure 3-53: Wearing sword equipment (slung)



Sword knots

3.200 With the cavalry and artillery sword, the sword knot hangs freely from the hilt to which it is attached by passing the strap through the slot from above, bringing the acorn through the loop on the guard side, and hauling taut.

3.201 With the infantry sword the sword knot is attached as follows:

- a. Lay the acorn on the guard by the slot, as shown in Figure 3-53.

Figure 3-54: Sword knots (step 1)

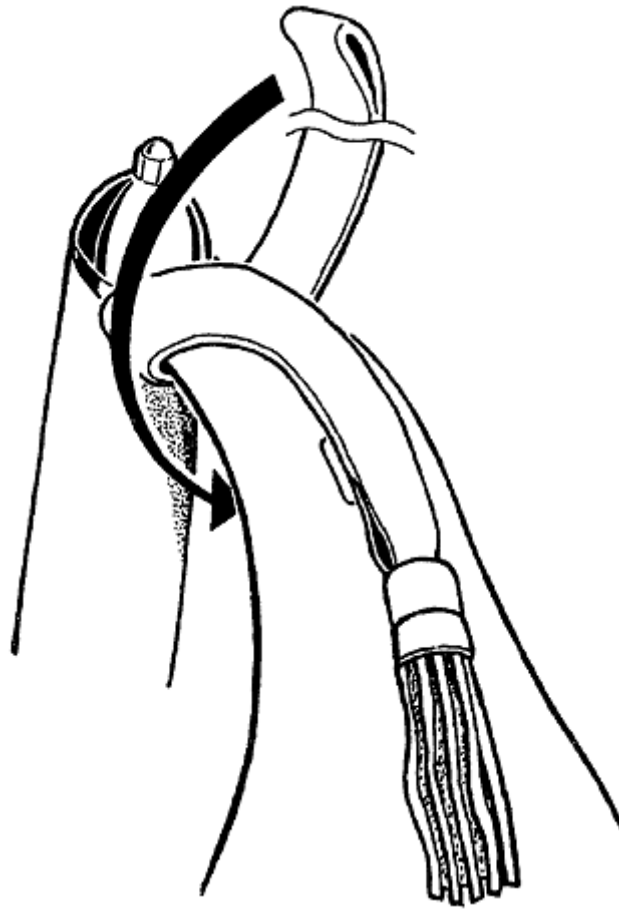

- b. Starting close to the handle and winding towards the outer curve of the guard, wind the spare end of the strap downwards around the guard as many times as possible, as shown in Figure 3-54.

Figure 3-55: Sword knots (step 2)

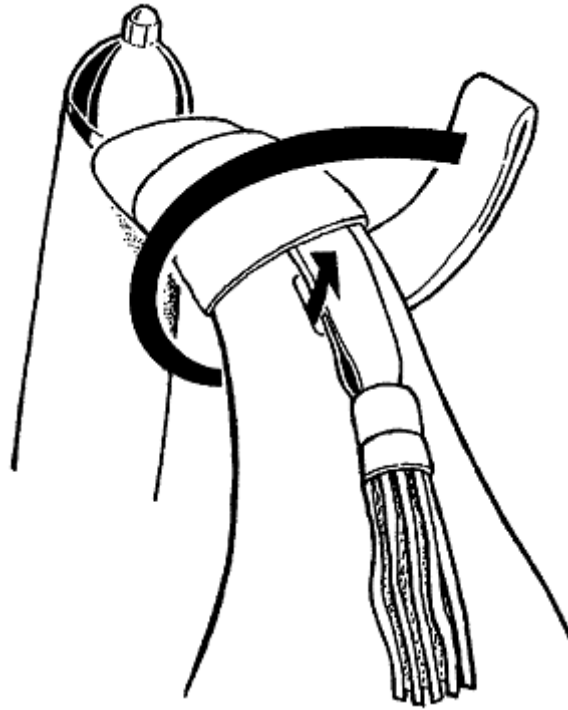

- c. Pass the end of the loop up through the slot from the inside and over the acorn, as shown in Figure 3-55.

Figure 3-56: Sword knots (step 3)

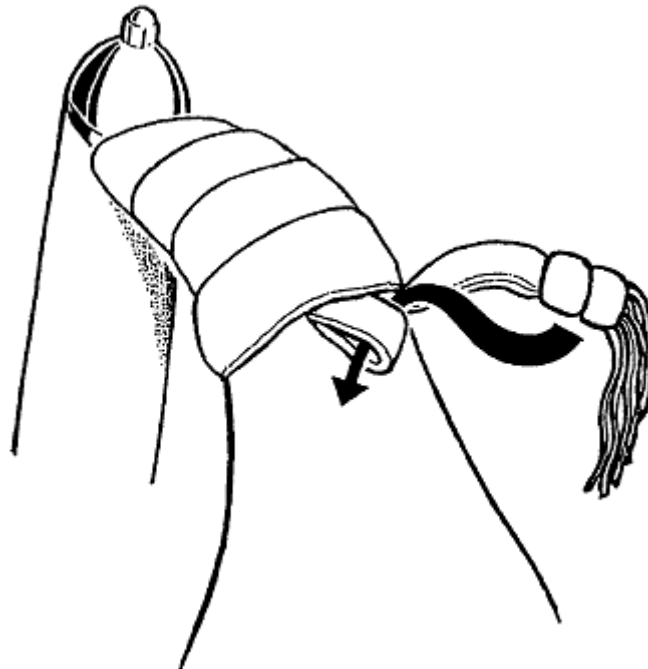

- d. Adjust the turns so that they are flat and taut on the guard and the acorn rests firmly against the hilt, as shown in Figure 3-56.

Figure 3-57: Sword knots (step 4)

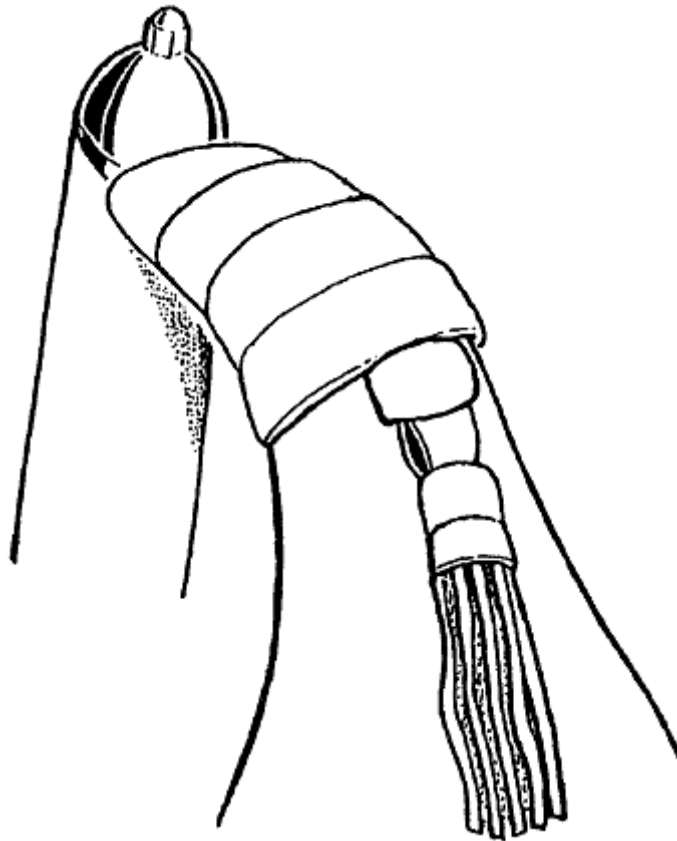

3.202 When sword equipment (slung) is worn in Figure 3-53, the sword knot is to be white as for sword infantry.

3.203 The swords, scabbards and sword knots to be used are in Table 3-8.

Table 3-8: Swords, Scabbards and Sword Knots

| Rank | Sword | Sword knot | Remarks |
|---|---|--|---------|
| General officers | Ceremonial sword (Mameluke) with steel scabbard | Gold and crimson sword knot with acorn | (a) (b) |
| Senior officers and special appointments | Sword with steel scabbard to be worn only with Patrol Blue orders of dress | Gold embroidered crimson sword knot with gold acorn | (a) (b) |
| Ensigns of Colour parties, RSM and Drum Major | Infantry/Artillery sword as applicable Steel Infantry/Artillery scabbard as applicable | White leather sword knot with acorn or leather tassels | (c) |
| Other officers and WO1 | Sword/sabre with brown/black leather scabbard and sword frog applicable to Corps | Brown/black leather sword knot with acorn or leather tassels | (a) (d) |

Notes:

(a) Ceremonial only.

ADM

3-79

- (b) General officers wear a Mameluke sword. BRIG and COL wear a steel scabbard and sword/sabre. A sword is not normally worn unless being received on parade or attending a ceremonial activity at which other spectators and guests would be wearing swords.
- (c) RSM carry pace sticks with sword equipment (slung).
- (d) RSM do not carry pace sticks when wearing swords with a Sam Browne Belt.

THONGS AND SANDALS

3.204 Thongs can be worn on Defence establishments, in line with in the following circumstances:

- a. when not on duty
- b. when moving to and from and within the shower/bathroom/change room
- c. when inside a living-in accommodation precinct
- d. when as an in-patient at a hospital but only when approved from the hospital commander or CO
- e. when recommended by a medical officer for medical reason
- f. when participating in water-sport activities that are inside the confines of a Defence swimming pool facility
- g. Thongs **can't** be worn inside Messing facilities, gymnasiums or in safety Critical Areas as defined in Base, Mess or Unit Orders

3.205 Thongs or sandals are not to be worn on civilian or Service aircraft, IAW [Chapter 2](#).

TROUSERS AND SLACKS

3.206 Trouser and slacks legs are to be long enough so that when worn, the front of the cuff or hem touches the 2nd bottom lace of the issue lace-up shoes or boots, and in the same position for the R.M. Williams boots. Trousers and slacks are to be pressed, IAW [Chapter 2](#).

3.207 AMCU trouser legs are worn bloused over the tops of the combat boots when wearing General Duty Dress (AMCU). AMCU trouser legs may be worn bloused or unbloused when wearing Field Dress (AMCU) or Combat Dress (AMCU).

3.208 Working and Protective Dress trousers are not to be worn bloused.

3.209 Mess Dress trousers and slacks. Mess Dress trousers and slacks are worn, IAW [Annex 5O](#).

UMBRELLAS

3.210 When wearing the Australian Army uniform, only a black umbrella (may be embossed with the Australian Army Rising Sun Badge) with a plain handle and ferrules is to be carried. An umbrella is not to be carried on parade. Umbrellas are not provided at Commonwealth expense.

UNDERWEAR

3.211 Underwear worn with uniform is not to be visible, other than the issued green, olive drab, light olive drab, khaki or sandy coloured T-shirt, Army logo green T-shirt and combat undershirt when worn with AMCU or Protective Dress. Personnel wearing AMCU or protective dress, may, when authorised, remove their shirts providing there is no screen-printed or embroidered logos, pictures, quotes, messages or unit titles and badges on the T-shirt - the Army logo green T-shirt as shown in Figures 3-59 and 3-60 is an exception to this rule. The Army logo green T-shirt should not be worn under body armour as the embroidered Rising Sun logo on the chest may cause rubbing. All undergarments are to be tucked into trousers/slacks/shorts at all times. Females are to wear appropriate under garments brassier/sport brassier when undertaking defence activities.

Figure 3-58: Army logo green T-shirt – front



Figure 3-59: Army logo green T-shirt – back



UNIT COLOUR PATCH

3.212 An authorised UCP is worn by all members of units, regiments or formations, with the exception of members of 1 RAR. The UCP is worn centrally on the right side of the puggaree of the Hat KFF. The UCP is removed on posting from the unit, regiment or formation. See the [Unit Colour Patch Register](#).

3.213 The request and administrative procedures and positioning of UCP is in [Annex 3D](#).

UNDERSHIRT AND DRAWERS EXTREME COLD WEATHER ENSEMBLE

3.214 The undershirt and drawers extreme cold weather ensemble, as shown in Figure 3-58 may be worn underneath all orders of dress, when climatic conditions warrant the wearing of such garments, except when wearing short sleeve shirts, protective dress shorts and mess dress orders of dress. When worn with General Duty Dress (AMCU) and Field Dress (AMCU), the garment may be visible. When worn with all other orders of dress, the garment is not to be visible.

Figure 3-60: Undershirt and drawers extreme cold weather ensemble



WET AND COLD WEATHER ENSEMBLE

Soft shell insulation layer

3.215 The soft shell insulation layer, in Figure 3-62 is the outermost level of protection designed for use in extreme cold and dry conditions. It is constructed of thermal insulation that provides wind protection and high warmth. The jacket ensemble is not to be embellished. Headdress is to be worn when wearing the jacket or ensemble, if the protective hood is not worn. When the jacket is worn in the barracks environment, it is to be zipped-up to either the collar or to breast pocket height, as shown in Figure 3-59. The jacket is not to be worn in public. The jacket may be worn unzipped in the field or on operations.

Figure 3-61: Soft shell insulation ensemble



Windproof and cold weather layer

3.216 The wet and cold weather layer, in Figure 3-60 is designed to be worn with base layers and uniform to provide wind and cold weather protection. It is windproof and breathable but not water resistant. The jacket ensemble is to only be embellished with the National Distinguishing Sign-ANF patch and badges of rank. Headdress is to be worn when wearing the jacket or ensemble, if the protective hood is not worn. When the jacket is worn in barracks or in public, it is to be zipped-up and buttoned to either the collar or to breast pocket height, as shown in Figure 3-60. The jacket may be worn unzipped in the field or on operations.

Figure 3-62: Windproof and cold weather layer

TBA

Wet weather layer

3.217 The wet weather layer, in Figure 3-61 is a waterproof barrier designed to be worn over other levels to provide protection from rain. It is constructed to provide water resistance and to be windproof whilst breathable but does not provide much warmth. The jacket ensemble is to only be embellished with the National Distinguishing Sign-ANF patch and badges of rank. Headdress is to be worn when wearing the jacket or ensemble, if the protective hood is not worn. When the jacket is worn in barracks or in public, it is to be zipped-up and buttoned to either the collar or to breast pocket height, as shown in Figure 3-61. The jacket may be worn unzipped in the field or on operations.

Figure 3-65: Wet weather layer

TBA

Annexes:

- 3A [Chief of Army endorsed range of combat boots](#)
- 3B [Chief of Army endorsed range of black combat boots](#)
- 3C [Administrative procedures of the Unit Shoulder Patch](#)
- 3D [Administrative procedures of the Unit Colour Patch](#)

CHIEF OF ARMY ENDORSED RANGE OF COMBAT BOOTS

1. Australian Army personnel may wear privately procured combat boots from the Chief of Army (CA) endorsed range of combat boots at their own expense, in the same colour range as the in-service/issued combat boot, within this annex.
2. The proper fitting of the in-service boot, by a boot fitting specialist, is to be permanently engaged to provide professional fitting advice at Army point of entry Q stores.
3. Members who purchase at their own expense or require a boot or a range of boots must provide as a minimum to the following:
 - a. durability
 - b. comfort
 - c. safety
 - d. protection
 - e. suitability for geography and climate
 - f. of uniform appearance, to aid identification in combat situations.
4. Those personnel who elect to wear individually procured combat boots while on exercise or operations, will be supplied the standard in-service combat boot, in the event that the privately procured combat boot becomes defective or unserviceable and requires to be replaced during the course of the exercise or operation.
5. All personnel retain an entitlement to be issued medically indicated non-standard footwear outside the normal size range due to the following circumstances:
 - a. abnormally large, small, wide or narrow feet/ankles
 - b. differently sized feet
 - c. suffering a medical problem.
6. Medically indicated footwear is special footwear chosen from proprietary brands (off-the-shelf) or made to measure to overcome medical problems and provide additional cushioning, shock absorbency, support, comfort or additional depth for the wearer and are to be issued.
7. The CA Endorsed Range of Combat Boots in Figure 3A–1 to Figure 3A–10, have been assessed against 15 key functional characteristics being, fit, cushioning, support, stability, traction, grip, flexibility, protection, environmental protection, health and hygiene, comfort, prevention of injury, safety, ease of donning and doffing, and durability.

8. Soldiers may purchase at their own expense from the following list of boots, which may be worn in barracks, in the field, on exercises or on operations.
9. **Salomon XA Forces Mid is to only to be worn in the field, on exercises, for PT or on operations. It is not to be worn in barrack except during PT.**

Figure 3A-1: Salomon XA Forces Mid



Figure 3A-2: ALTAMA 4158 3LC Hot Weather



Figure 3A-3: ALTAMA 4156



3A-3

Figure 3A-4: BELLEVILLE M590 Hot Weather



Figure 3A-5: BELLEVILLE M591 Hot Weather



Figure 3A-6: BATES 30501 Durashock Desert



3A-4

Figure 3A-7: CROSSFIRE Peacekeeper Plus



Figure 3A-8: DANNER Arcadia Desert



Figure 3A-9: MEINDL Desert Fox Safari



3A-5

Figure 3A-10: LOWA Urban Desert



Figure 3A-11: GARMONT T8 Multi Terrain



CHIEF OF ARMY ENDORSED RANGE OF BLACK COMBAT BOOTS

1. Selected Australian Army personnel may wear privately procured black combat boots from the Chief of Army (CA) endorsed range of black combat boots at their own expense, in the same colour range as the in-service/issued black combat boot, within this annex.
2. Members who purchase at their own expense or require a boot or a range of boots must provide as a minimum to the following:
 - a. durability
 - b. comfort
 - c. safety
 - d. protection
 - e. suitability for geography and climate
 - f. of uniform appearance, to aid identification in combat situations.
3. Those personnel who elect to wear individually procured black combat boots while on exercise or operations, will be supplied the standard in-service black combat boot, in the event that the privately procured combat boot becomes defective or unserviceable and requires to be replaced during the course of the exercise or operation.
4. All personnel retain an entitlement to be issued medically indicated non-standard footwear outside the normal size range due to the following circumstances:
 - a. abnormally large, small, wide or narrow feet/ankles
 - b. differently sized feet
 - c. suffering a medical problem.
5. Medically indicated footwear is special footwear chosen from proprietary brands (off-the-shelf) or made to measure to overcome medical problems and provide additional cushioning, shock absorbency, support, comfort or additional depth for the wearer and are to be issued.
6. The CA endorsed range of black combat boots in Figures 3B-1 and 3B-2, have been assessed against 15 key functional characteristics being, fit, cushioning, support, stability, traction, grip, flexibility, protection, environmental protection, health and hygiene, comfort, prevention of injury, safety, ease of donning and doffing, and durability.

ADM

OFFICIAL

3B-2

Figure 3B-1: Oakley S.I. Assault Boot TM

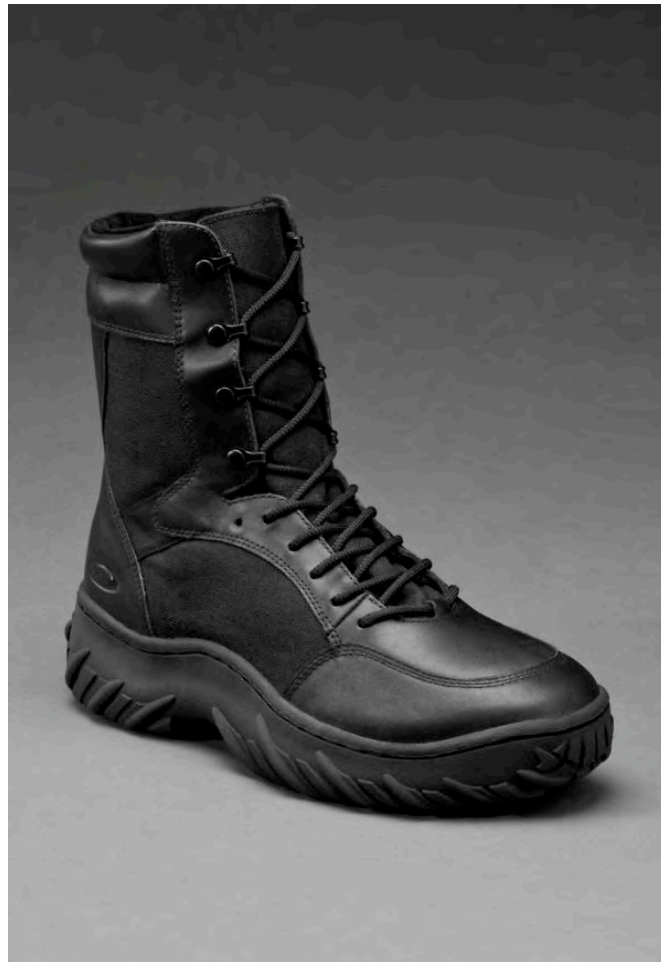

8 inch, also available in 6 inch

AL5

OFFICIAL

Figure 3B-2: TERA Heat Resistant Black Boot



ADMINISTRATIVE PROCEDURES OF THE UNIT SHOULDER PATCH

SPECIFICATIONS

1. The Unit Shoulder Patch (USP) is to be unique to each unit and is to be worn collectively by the unit, not individual company/platoon/section/trade patches. Where members are entitled to wear multiple patches (USP, trade patch, identification arm patch), the Chief of Army and/or formation commander is to direct policy on which patch is to be worn in the unit. USP are not to be affixed with qualification or trade badges.
2. The USP is to have the HQ/formation colours as a background and be rectangular, 7.5 cm in length and 5.5 cm high. All USPs are to be produced with khaki coloured, embroidered bordering.

Special Operations Command

3. Australian Multi-cam Camouflage Uniform (AMCU) backed USP have been specifically designed and allocated for Special Operations Command (SOCOMD) units and Head Quarters Joint Operations Command (HQ JOC) and are to be worn in a barracks environment. Only SOCOMD units and HQ JOC members are authorised to wear the USP with AMCU background. As the AMCU material is restricted, a user specification request is required to be raised through Director Logistics–Army (DLOG–A), once the USP has been approved by Director-General Army People Capability (DGAPC).
4. All AMCU backed patches will be assigned an NSN and are to be purchased at the units' expense through Capability Acquisition and Sustainment Group (CASG).
5. All USP approved by DGAPC for wear by Army personnel are in the [Unit Shoulder Patch Register](#)¹².
6. Army personnel are not to wear patches not identified in the approved listing above. Any variations or amendments to approved patches are to be processed to DGAPC, in accordance with (IAW) the submission protocol below.

¹² <http://www.army.gov.au/Our-work/Equipment-and-clothing/Army-Dress-Manual/Unit-Shoulder-Patch-Register>

SUBMISSIONS

7. All submissions for a USP are to be in Minute format to DGAPC. The submission is to include the following information:
 - a. Justification for introduction or amendment of a patch.
 - b. Design specifications and justification – including the preferred colours and symbology of the design.
 - c. Two drawings of the proposed USP with dimensions – one in colour and one a black and white line drawing. On receipt of the application the Ceremonial Cell will request the Unit provide both of these images in electronic format. The format must be either in Coral Draw or Illustrator.
8. All applications are to be endorsed by the formation commander before they are submitted to DGAPC for approval.

AUTHORISATION

Army units

9. All USPs are to be approved by DGAPC before they are procured by the unit. The USP design and colour is to be in line with the unit history and its heritage. The submission of a new USP design is to be sent to Army Ceremonial and can only be approved by DGAPC. Once approved DGAPC will provide the specifications for the USP, including sizing and colour.

Non-Army groups

10. Personnel posted to organisations within the Non-Army Group, including Royal Australian Navy, Royal Australian Air Force and CASG, are to confirm that approval has been given by DGAPC to wear that units' USP. Where approval has not been given, the unit is to submit a request, IAW paragraph 7 to this annex.

Tri-Service units

11. Regardless of which Service initially approves the USP, all Tri-Service unit USPs must be approved by all three Services and the ADF Brand Manager, prior to being worn.

ENTITLEMENT

12. All personnel, other than recruits and initial employment trainees, are to wear a USP. The specific applications for wearing are as follows:
 - a. Only units and sub-units identified on the Army ORBAT may request to procure and wear a USP.
 - b. All personnel on the posted strength of a unit are to wear that units' USP during the posting. That USP is to be removed when re-posted from that unit.

OFFICIAL

ADM

3C-3

- c. Members posted to an Army unit and then detached are to retain their posted units' USP.
- d. Recruits, initial employment trainees and OCDTs (other than Corps of Staff Cadets) will be issued their USP on posting to a unit, upon completion of such training or upon arrival to their new unit.
- e. Honorary appointments of a Corps or Regiment, when wearing the uniform of their honorary appointment, may wear the USP of the Regiment/Corps. Head of Corps (HOC) / Head of Regiment (HOR) may wear the Regiment/Corps USP, embroidered with the appointment title, 'HOC/HOR'.

PURCHASE

- 13. Units are to purchase the USP using Direct Unit Funding. USPs are to be purchased from a provider who can produce the DGAPC approved design, specifications and colours.

POSITIONING THE UNIT SHOULDER PATCH

- 14. USP is to be on the Velcro patch on the right sleeve of the AMCU shirt. They are not approved for wear on other orders of dress or other items of clothing. The correct positioning of a USP on the AMCU shirt is in Figure 3C-1.

AL5

OFFICIAL

Figure 3C-1: Positioning the Unit Shoulder Patch on the Disruptive Pattern Combat Uniform/Australian Multi-cam Camouflage Uniform shirt



ADMINISTRATIVE PROCEDURES OF THE UNIT COLOUR PATCH

ENTITLEMENT

1. Entitlement to Unit Colour Patch (UCP) is determined by Director-General Army People Capability (DGAPC). UCP allocation is taken in response to either a unit application (Series I) or establishment variation (Series I and II).
2. On the creation, merging or disbandment of a unit, Army Ceremonial is responsible for assigning or reserving the UCP. Unit requesting to use an established UCP are to provide a Minute to DGAPC with a justification, including historical linkage and role.
3. All personnel, other than recruits and initial employment trainees are to wear a UCP. The specific applications for wearing are as follows:
 - a. All personnel on the posted strength of a unit are to wear that unit's UCP while so posted. That UCP is to be removed when reposted from that unit. The exceptions to this order are personnel posted to Long-term Student, manpower not required for establishment and protective security detachment (Army) for which there are no UCP; these personnel are to continue to wear their previous unit's UCP.
 - b. The unit UCP is to be retained throughout all periods of detachment, except in paragraph 3(c) to this annex, eg courses, hospitalisation, temporary detachment for duty, overseas exchange exercises, overseas visits.
 - c. Members posted to an Army unit and then detached are to retain their posted units' UCP.
 - d. Recruits, initial employment trainees and OCDTs (other than Corps of Staff Cadets) will be issued their UCP on posting to a unit, upon completion of such training or upon arrival to their new unit.
 - e. Honorary appointments of a Corps or Regiment, when wearing the uniform of their honorary appointment, may wear the UCP of the Head of Corps (HOC) / Head of Regiment (HOR) Cell on the puggaree on the Hat Khaki Fur Felt (KFF). Alternatively, such officers, if wearing the badges of rank and other insignia of the rank held on the Active List, Inactive Reserve or of the military rank or title granted on retirement, may wear on the Hat KFF the UCP of the unit last served with on the Active List.
4. All applications are to be endorsed by the formation commander before they are submitted to DGAPC for approval.
5. The Series II UCP are produced on a 40 mm square base, and Series I/Series I (extended) have been scaled proportionately to the Series II size.

The sizes are based on the space available on the puggaree of the Hat KFF and are not to be altered.

6. All UCP approved for wear by Units are in the [Unit Colour Patch Register](#)¹³.
7. UCPs identified in the register are displayed as worn on the right side of the Hat KFF.

PURCHASE

8. Units are to purchase the UCP using Direct Unit Funding. UCPs are to be purchased from a provider who can produce the DGAPC approved design, specifications and colours.

POSITIONING THE UNIT COLOUR PATCH

9. UCP is worn centrally on the right side of the puggaree of the Hat KFF with ceremonial and general duty orders of dress. They are not approved for wear on other forms of headdress or other items of clothing. The correct positioning of a UCP on the puggaree of the Hat KFF is in Figure 3D-1.

Figure 3D-1: Positioning the Unit Colour Patch on the Hat Khaki Fur Felt



¹³ <http://www.army.gov.au/Our-work/Equipment-and-clothing/Army-Dress-Manual/Unit-Shoulder-Patch-Register>

NORFORCE - INDIGENOUS ARTWORK ON PACE STICK

Artist – Mr Gary Manbulloo, JAWOYN Nation.

The artwork on the NORFORCE Pace Stick represents two (2) major skin groups from the Jawoyn People, the traditional owners of the country surrounding the Katherine N.T. area.

The dark brown area represents the skin (*Moiety*), group of the artist, Mr Gary Manbulloo, known as *Dunwah*.

The light brown are represents the other skin (*Moiety*), group of the Jawoyn people, known as *Yirritja*.

The thin (criss-cross) markings represents numerous traditional rock art throughout Jawoyn country.

The thick lines represents the land boundaries which separate Jawoyn country from neighbouring clans.

Both skin groups share similar art styles and traditional ceremonies. Their paintings and artwork depicts country by, dancing, local animals and the JAWOYN people's use of use bark paintings.



Relevance of the JAWOYN People to NORFORCE.

There is historical lineage between the JAWOYN Nation and the North West Mobile Force.

In 1942, the 2/1st North Australia Observer Unit was formed as an Australian Army reconnaissance unit of World War II. The unit was commanded by Lieutenant Colonel Bill Stanner, the unit's headquarters was established in Katherine, Northern Territory.

The unit's manning had peaked to 550 personnel and this included 59 guides who were aboriginal men. Although the headquarters for the North West Mobile Force was established at Larrakeyah Army Barracks in 1981, NORFORCE can trace it's history back to the 2/1st Northern Australia Observer Unit.

The decision to request the JAWOYN Nation to depict its strong cultural history on the pace stick of the Regimental Sergeant Major of NORFORCE, highlights and pays tribute to those

indigenous men who served as soldiers and guides, during a time when the indigenous participation rate low and the Australian first nation's people were recognised under the flora and fauna act.

This pace stick, which is only carried during commemorative and ceremonial parades and events, is a tribute to all first nation people who have served NORFORCE and the Australian Army.

CHAPTER 4

INTERPRETATION OF THE ARMY DRESS MANUAL

The Army Dress Manual is to be interpreted as positive instructions, meaning if a situation is **not** specified in the Army Dress Manual, it is therefore **prohibited**; however, elements of this manual provide specific direction to the reader.

BADGES AND EMBLEMS

AUSTRALIAN ARMY RISING SUN BADGE

4.1 The Australian Army Rising Sun Badge is traditionally worn by members of the Australian Army and is the authorised emblem of the Australian Army. The large Australian Army Rising Sun Badge is worn on the left side of the Ceremonial Hat Khaki Fur Felt (KFF) (brim up) by all personnel. The Australian Army Rising Sun Badge is not to be worn on the General Duty Hat KFF (brim down). Selected personnel in [Chapter 1](#), wear the 4 cm miniature collar badges in lieu of Corps/Regiment collar badges. The metal badge is produced only in gold finish and is issued in two sizes. The authorised design is in Figure 4–1.

Figure 4–1: Australian Army Rising Sun Badge



4.2 The miniature size badge is worn on the Hat KFF and Blue Service caps in lieu of Corps/Regiment badges by the following personnel:

- a. an Army OCDT (other than Corps of Staff Cadet) at Australian Defence Force Academy (ADFA).
- b. the Army component of the Australian Federation Guard (AFG).

4.3 Miniature badges are worn as collar badges in lieu of Corps/Regiment badges by Regimental Sergeant Major of the Army, Tier C Regimental Sergeant Major appointments and selected personnel in [Chapter 1](#), and the Army component of the AFG.

Positioning the badge on the Ceremonial Hat Khaki Fur Felt

4.4 The badge is positioned centrally on the left side brim, facing outward when the brim is turned up. The highest point of the badge is to be 1.5 cm below the edge of the brim, as shown in Figure 4-2.

Figure 4-2: Australian Army Rising Sun Badge positioning on the Ceremonial Hat Khaki Fur Felt

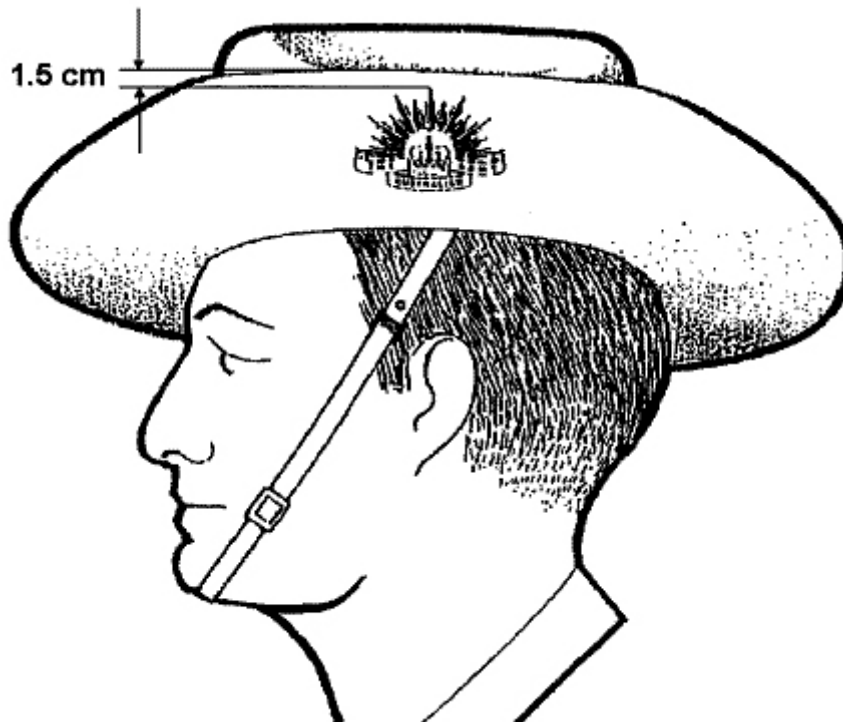

Positioning the badge on the Blue Service cap

4.5 Selected and special appointment personnel in [Chapter 1](#), wear the small Australian Army Rising Sun Badge in the same manner Corps/Regiment badges. The badge is positioned centrally on the front of the cap, in line with the sewn seam on the cap. The badge is to be positioned 1 cm above the top edge of the chin strap, in accordance with (IAW) [Annex 4D](#).

Positioning the badge on the collar

4.6 When the Australian Army Rising Sun Badge is worn as collar badges, they are positioned on the Service Dress and Patrol Blue orders of dress in the same

manner as Corps/Regiment badges are positioned on the garment, IAW [Annex 4D](#). The positioning of collar badges on mess dress orders of dress is IAW [Annex 5O](#).

4.7 The Australian Army Rising Sun Badge is worn as a unit badge by all OCDTs at ADFA, Army recruits and the Army component of the AFG. The badge is to be worn by individuals performing national representational duties, when ordered, such as Equerry to the Queen.

4.8 An embroidered Australian Army Rising Sun Badge on an appropriate coloured background is worn on the top of the left sleeve of Service Dress, polyester shirt, Utility jacket, maternity blouse, Patrol Blue orders of dress, Australian Multi-cam Camouflage Uniform (AMCU) shirt and Mess Dress jacket. All Australian Army Rising Sun Badges are to be oval in shape; however, square badges may be worn until stocks run out.

Embroidered Australian Army Rising Sun shoulder badge

4.9 The Australian Army Rising Sun Badge embroidered on appropriate backgrounds is worn on the left sleeve of the following garments:

- a. A gold badge embroidered on khaki background is worn on the following garments:
 - (1) Service Dress jacket
 - (2) polyester shirt
 - (3) Utility jacket.
- b. A black badge embroidered on AMCU background is worn on the following garments:
 - (1) AMCU shirts
 - (2) AMCU General Purpose jacket.
- c. A gold badge embroidered on white background is worn on the following garments:
 - (1) Mess Dress White Jacket
 - (2) Patrol Blue White Jacket.
- d. A gold badge embroidered on blue/black background is worn on the following garments:
 - (1) Patrol Blue Jacket
 - (2) Senior Officer Mess Dress.

- e. A metallic gold badge embroidered on black background is worn on the following garments:
 - (1) Senior Ranks Mess Dress
 - (2) Mess Dress Army.
- f. A bullion badge on blue/black background may be worn by Senior Officers Mess Dress.
- g. A black badge embroidered on AMCU background is not worn on Protective Dress garments.

4.10 The Australian Army Rising Sun shoulder badge is positioned on shirts with the centre of the top edge of the badge 1 cm below the centre of the top of the sleeve, IAW Figure 4-3. The badge is to be aligned on a vertical line from the centre of the shoulder to the centre of the cuff. The badge may not be parallel to the shoulder seam. On jackets and sweater khaki lightweight the oval badge is positioned 2 cm below the centre of the top of the sleeve.

Figure 4-3: Positioning the embroidered/bullion Australian Army Rising Sun Shoulder Badge

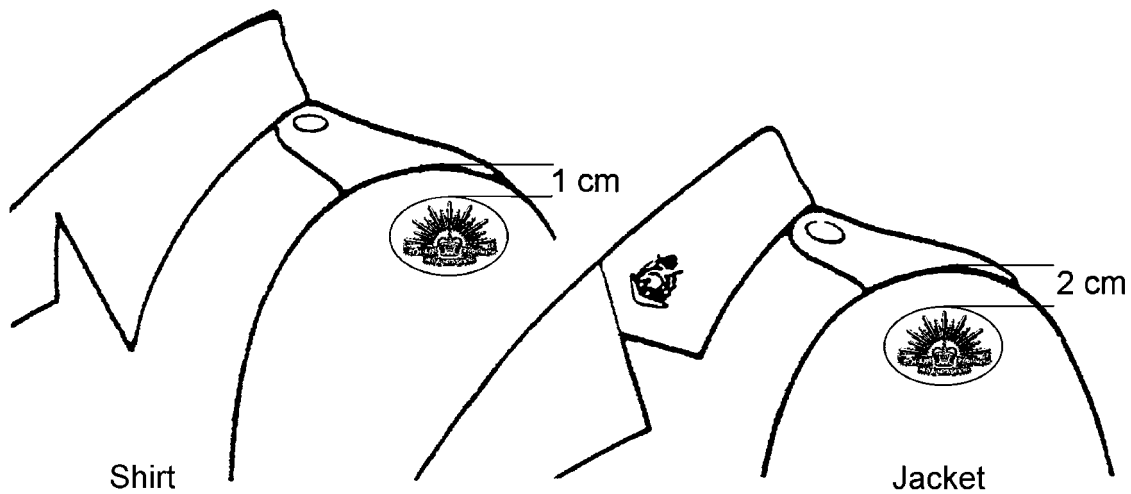

AIRCREW BADGES

4.11 Aircrew badges are to be worn by qualified personnel on flying suits and all orders of dress, except AMCU, Garrison jacket, raincoat, overcoat lightweight or Protective Dress. A qualified member is entitled to wear an aircrew badge in perpetuity. The description, wearing and positioning of the Aircrew badges is in [Annex 4A](#).

ARMY COMBAT BADGE

4.12 The Army Combat Badge (ACB) is not an award but a badge presented to an entitled individual and only one badge is to be worn per individual. An individual who has been presented the Infantry Combat Badge (ICB) is not eligible for the ACB. An individual who has been presented the ACB and becomes eligible for the ICB may

elect to return the ACB and be presented the ICB. A member qualified, IAW [Army Standing Instruction \(Personnel\) \(ASI\(P\)\) Part 11 Chapter 3—Army Combat Badge](#)¹⁴ is entitled to wear the ACB in perpetuity. Regardless of the number of deployments, members are only entitled to one ACB. The description, wearing and positioning of the ACB is in [Annex 4B](#).

ARMY INDIVIDUAL READINESS NOTIFICATION BADGE

4.13 The Army Individual Readiness Notification (AIRN) Badge is worn by all AIRN compliant personnel. The AIRN Badge is to be removed when an AIRN report is raised categorising an individual as not ready for reasons within their control. The badge is not worn again until an AIRN report is raised categorising an individual as ready. The description, wearing and positioning of the AIRN Badge is in [Annex 4C](#).

CORPS AND REGIMENT BADGES

4.14 Corps/Regiment badges are produced in a range of designs and colours according to Corps. Most Corps/Regiment badges are produced in a large size for hat, cap and beret and a small size, often in pairs which are designed to be worn on the left and right sides of specific uniforms, as collar badges. The Royal Australian Artillery (RAA) has distinctive hat, cap and collar badges for officers and WO1, which are only to be worn by those ranks; the Royal Australian Engineers has distinctive collar badges for officers and WO1. RAA members are to wear the miniature RAA hat badge in lieu of the large RAA hat badge when wearing the beret. The miniature RAA hat badge is to be purchased at the members' expense. Only RAA officers may wear the coloured embroidered cloth hat badge on the beret in lieu of the metal hat badge. The coloured embroidered cloth hat badge is to be purchased at the members' expense. The description, wearing and positioning of the Corps/Regiment badges is in [Annex 4D](#).

INFANTRY COMBAT BADGE

4.15 The ICB is worn by eligible personnel and is awarded per individual. An individual who has been awarded the ICB is not eligible for the ACB. A member qualified, IAW [ASI\(P\) Part 11 Chapter 4—Infantry Combat Badge](#)¹⁵ is entitled to wear the ICB in perpetuity. The description, wearing and positioning of the ICB is in [Annex 4E](#).

MILITARY INSTRUCTOR BADGE

4.16 To be eligible for receipt of the Military Instructor Badge (MIB), a member must be currently serving in the ADF and employed in a designated instructor/Assessor or training supervisor positions. They must have successfully completed the competencies or courses as directed in ATI 1–14/2015. The approving authority for the MIB is the DGT. The issuing authority is the Commandant

¹⁴ <https://objective/id:R26414332>

¹⁵ <https://objective/id:R26414343>

(COMDT)/Commanding Officer (CO)/CI of the respective Army Training Centres/Establishment. Regardless of subsequent postings, a member qualified IAW I&ADP is entitled to wear the MIB in perpetuity. The description, wearing and positioning of the MIB is in [Annex 4E](#).

PARACHUTIST BADGES

4.17 Appropriate parachutist insignia are worn by qualified personnel on the right sleeve. Eligible personnel may also wear the appropriate brevet as indicated in [Annex 4G](#). The brevet is worn above the left breast pocket. Parachutist insignia are not worn on AMCU, Garrison jacket, raincoat or any order of Protective Dress. A qualified member is entitled to wear a parachutist badge in perpetuity. The description, wearing and positioning of parachutists badges is in [Annex 4G](#).

RANK INSIGNIA

4.18 Appropriate rank insignia is to be worn by all Australian Army personnel whilst wearing the Australian Army uniform with all orders of dress, except raincoats and overcoat lightweight. However, the exception to this order only applies to PTE (E) rank members who have no specific badge of rank or for selected SOCOMD personnel, when ordered by the commander or CO of Special Operations Command (SOCOMD) units. The description, wearing and positioning of rank insignia is in [Annex 4H](#).

RECRUIT INSTRUCTOR BADGE

4.19 To be eligible to wear the Recruit Instructor Badge (RIB), or to be eligible for the award of the RIB a member must be a currently serving Corporal (CPL) or Sergeant (SGT) in the ADF and employed in a designated Recruit Instructor (RI) position, ECN 347, at ARTC and have successfully completed all competencies as directed in ATI 1-14/2015. Additionally, members must complete a minimum of six months at 1 RTB and demonstrate effective service as a Military Instructor, reported on the Performance Appraisal Supplementary Report for Soldiers, AC833-30, with an overall performance rating of good in two platoons. The approving authority for the RIB is the DGT. The issuing authority is the COMDT/CO/CI of the respective Army Training Centres/Establishment. Regardless of subsequent postings, a member qualified IAW 1 RTB Standing Orders is entitled to wear the RIB in perpetuity. The description, wearing and positioning of the RIB is in [Annex 4I](#).

RETIRED MEMBER INSIGNIA

4.20 An officer may apply in writing to the CA through Director-General Career Management–Army (DGCM–A), for approval to use their military title on separation; however, approval is not automatic. If approval is granted, an officer is entitled to use the post-nominal ‘Retd’ when using their military title. An officer granted a military title may, on occasions authorised by CA or their delegate, wear their uniform with the gold or silver/chrome ‘R’ insignia.

4.21 Under Defence (Personnel) Regulations 2002, ORs are not authorised to use their military title after separation and cannot be approved to use the post-nominal 'Retd' title. An OR may apply in writing to the CA through DGCM–A, for approval to wear their military uniform after separation; however, approval is not automatic. If approval is granted, an OR may on occasions authorised by CA or their delegate, wear their uniform without the 'R' insignia.

4.22 The 'R' insignia is not worn by members of the Inactive Reserve. The description, wearing and positioning of the Retired Member insignia is in [Annex 4J](#).

ROYAL CYPHER AND CROWN INSIGNIA

4.23 The large insignia is worn by officers holding appointment to the Sovereign, ie Australian Defence College (ADC) General, ADC, Honorary ADC, Equerry, Extra Equerry, Honorary Chaplain, Honorary Physician, Honorary Surgeon, Honorary Dental Surgeon and Honorary Nursing Sister.

4.24 All appointments remove the insignia on termination of the appointment. ADC General and ADC are entitled to wear the small insignia after termination of those appointments unless they are officers of substantive Major General or above.

4.25 The insignia is not worn by personnel holding honorary appointments to the Governor-General or State Governors. The small gold insignia is also worn by all civilian household staff at Government House in Canberra. The description, wearing and positioning of the Royal Cypher and Crown insignia is in [Annex 4K](#).

SERVICE/DEFENCE COMMENDATION BADGES

4.26 Personnel awarded a Defence Commendation are to wear the badge signifying the award on all general duty (polyesters), general duty Service dress and ceremonial orders of dress. The Badge is worn on the right above the pocket, AIRN Badge and unit and group citations, on shirts and jackets. If two or more commendation badges from the same service and/or the same level are awarded, a maximum of four badges may be worn, regardless of the level, with the senior commendation positioned to the right. A maximum of three commendations are to be worn per row regardless of gender. If four commendations/medallions are awarded, they are worn in two rows with the senior being positioned centrally above the other commendations/medallions. Where an ADF and Army commendation have been awarded, the ADF commendation is worn to the right. If a RAN, RAAF or Defence Support Services commendation has been awarded as well as an ADF or Army commendation, the RAN, RAAF or Defence Support Services commendation is worn to the left. The description, wearing and positioning of Defence commendation badges is in [Annex 4L](#).

SKILL AT ARMS BADGE

4.27 A Skill at Arms Badge, ie Crossed Rifles, Sniper or Army Top 20 is worn by qualified personnel on the left sleeve of shirts and jackets below the Australian Army Rising Sun Badge. Skill at Arms badges are not worn on AMCU, Garrison jacket, raincoat, overcoat or any order of Protective Dress. A qualified member is entitled to wear a Skill at Arms Badge in perpetuity after meeting the criteria in paragraph 4 to

[Annex 4M](#). The description, wearing and positioning of the Skill at Arms Badge is in [Annex 4M](#).

SOLDIERS MEDALLION BADGE

4.28 The Soldiers Medallion Badge is issued with the Soldiers Medallion for Exemplary Service (SMES). Once awarded, the SMES Badge can be worn by all ranks. The SMES Badge is worn on the right above the pocket, AIRN Badge and unit and group citations, on shirts and jackets. A maximum of four SMES badges may be worn. A maximum of three SMES badges are to be worn per row. If four SMES badges are awarded, they are worn in two rows. When a Defence commendation has been awarded, the commendation is worn to the right or in the senior position. If a Defence commendation has been awarded, a maximum of four commendations/SMES badges are only to be worn. The description, wearing and positioning of the SMES Badge is in [Annex 4N](#).

TRADE QUALIFICATION BADGES

4.29 Trade qualification badges are worn in perpetuity by qualified personnel. Eligibility is determined by trade sponsors. If a member is determined by a trade sponsor to be below the qualifying standard at any time, the right to wear the badge of that trade is forfeited and the badge must be removed on promulgation of forfeiture of trade qualification. Any items of dress that require replacing as a result of the removal of the trade badges are to be replaced at the members' expense. The description, wearing and positioning of the trade qualification badges is in [Annex 4O](#).

UNIT AND GROUP CITATIONS AND AWARDS

4.30 Emblems of Unit and Group Citations and awards which are automatically authorised to be worn by members of the Australian Army are Australian awards:

- a. Unit Citation for Gallantry (UCG)
- b. Group Bravery Citation
- c. Meritorious Unit Citation (MUC).

4.31 The conditions for wearing the emblem of Unit Citations and awards are as follows:

- a. Personnel posted to the unit for the period the citation was awarded wear the emblem with the Federation Star device in perpetuity with ceremonial, general duty (polyesters), general duty Service dress and mess dress orders of dress.
- b. Personnel posted to units or sub-units which have been awarded unit citations wear the emblem of the award with ceremonial, general duty (polyesters), general duty Service dress and mess dress orders of dress for the duration of that posting only.

4.32 Second and subsequent awards of the UCG or the MUC are recognised by the presentation of a further Certificate of Citation to the unit signed by the Governor-General. Only one insignia of either citation may be worn. Only one Federation Star device is worn, irrespective of the number of awards made to units to which a member may be posted. The description, wearing and positioning of the emblems of Unit Citation and awards is in [Annex 4P](#).

4.33 The conditions for wearing the emblem of a Group Bravery Citation and award is a group of personnel who have been awarded for a collective act of bravery in extraordinary circumstances and signed off by the Governor General and the Australian Decorations' Advisory Committee.

NON-ADF AND FOREIGN MILITARY AWARDS, BADGES, UNIT CITATIONS AND COMMENDATIONS

4.34 On occasion, members of the ADF will be offered awards, badges, unit citations and commendations from agencies external to the ADF or Foreign military services. These are not to be confused with Foreign honours and awards in [Annex 6D](#) and the [Defence Honours and Awards Manual](#)¹⁶ which include the following:

- a. US Presidential Unit Citation
- b. US Army Combat Action Badge
- c. US Meritorious Unit Commendation
- d. UN Commendations.

4.35 ADF personnel may accept awards, badges, unit citations and commendations conferred upon them for service with another agency or foreign military service. However, prior to wearing the insignia, members must apply to DGAPC for permission to wear the insignia and have it recorded on PMKeyS. **Not all** foreign military Individual or Group will be approved to be worn. Trade badges **will be not** be approved to be worn, restricted wear can be approved.

Members of the ADF

4.36 To be eligible for consideration, the award must have been presented for service while serving and operating as an ADF member and the award is either part of the Foreign or Australian Honours and Awards system. Where the member received the award for service while employed by another agency other than the ADF, approval will not be given, eg a commendation received as a member of a State Police Force.

¹⁶ <http://intranet.defence.gov.au/home/documents/departmental/manuals/dhamv2.htm>

Equivalence

4.37 In assessing a members' eligibility to wear the award, an equivalence assessment is conducted against awards, badges, unit citations and commendations available in the Service recognition system. The assessment of equivalence is based on the quality of the service for which the award is made and the criteria for the award. The title of a particular award does not necessarily indicate equivalence, eg the US Presidential Unit Citation could be equated to the Unit Citation for Gallantry; however, the US Army Combat Action Badge has no equivalency in the ADF system.

4.38 Where no equivalency can be established approval will not be given to wear the award. However, if the award is part of a formal honours and awards system and was presented for service while serving and operating as an ADF member, the award can still be entered onto the 'Recognised Achievements' panel of PMKeyS by Army Ceremonial, in order to ensure that it will appear on the members 'Discharge Certificate' at separation.

Applications

4.39 Applications to wear the insignia are to be submitted by a Minute through the members chain-of-command to DGAPC. The application is to include the following:

- a. any documentation which confirms the member received the award
- b. a certified true copy of a certificate
- c. citation with a list of authorised personnel
- d. a letter from the agency or Foreign military service detailing the awarding to the member.

4.40 A Statutory Declaration will not be considered sufficient evidence.

4.41 Members will receive a Minute from DGAPC advising the outcome of their application and the method in which the insignia is to be worn, if approval is given.

Transfer between Services

4.42 Members who transfer to Army from the RAN or RAAF are required to submit an application to wear the insignia, IAW paragraph 4.39-4.41, irrespective of any approval given by the previous service.

PMKeyS

4.43 Entry on the 'Recognised Achievements' panel of PMKeyS does not automatically infer permission to wear the insignia. Members must have received a Minute from DGAPC approving the wearing of the insignia.

Insignia replacement

4.44 Once a member is approved to wear the insignia, the ADF takes no responsibility for the replacement of the insignia, should it be lost, stolen or damaged. Any replacement is to be at the members' expense.

4.45 As the approving authority, DGAPC has the capacity to withdraw approval to wear the award, if evidence is found that the award does not meet the equivalence assessment which then deems the member is ineligible for the award.

Positioning of Foreign military commendations

4.46 Personnel approved to wear a Foreign military Commendation by DGAPC may wear the badge, IAW paragraph 4.26. The following conditions apply to the wearing of Foreign military commendations:

- a. ADF Commendations take priority over any Foreign military commendation(s) in the order or precedence
- b. where a member has received multiple Foreign military commendations, they are to be worn after any ADF commendations, in the order that they are approved for wear.

4.47 The description, wearing and positioning of Foreign military commendation badges are applied in the same manner as ADF commendations, IAW [Annex 4L](#).

Annexes:

- 4A [Aircrew badges](#)
- 4B [Army Combat Badge](#)
- 4C [Army Individual Readiness Notification Badge](#)
- 4D [Corps/Regiment badge](#)
- 4E [Infantry combat badge](#)
- 4F [Military instructor badge](#)
- 4G [Parachute badges](#)
- 4H [Rank badges and insignia](#)
- 4I [Recruit instructor badge](#)
- 4J [Retired Member Insignia](#)
- 4K [Royal Cypher and Crown insignia](#)
- 4L [Defence Commendations](#)
- 4M [Skill at Arms Badge](#)
- 4N [Soldiers Medallion Badge](#)
- 4O [Trade qualification badge](#)
- 4P [Unit and Group Citations](#)

AIRCREW BADGES

DESCRIPTION

1. Aircrew badges are authorised for the following aircrew categories:
 - a. Pilot
 - b. Observer
 - c. Aircrewman
 - d. Technician
 - e. Flight Test Engineer.
2. The design of aircrew category badges is in Figure 4A–1 and as follows:
 - a. Pilot—a wing with the royal crest in the centre
 - b. Observer—the letter ‘O’ and a wing surmounted by a crown
 - c. Aircrewman—the letter ‘A’ surrounded by a wattle wreath and a wing surmounted by a crown
 - d. Technician—the letter ‘T’ surrounded by a wattle wreath and a wing surmounted by a crown
 - e. Flight Test Engineer—the letter ‘E’ surrounded by a wattle wreath and a wing surmounted by a crown.

Figure 4A-1: Aircrew badges

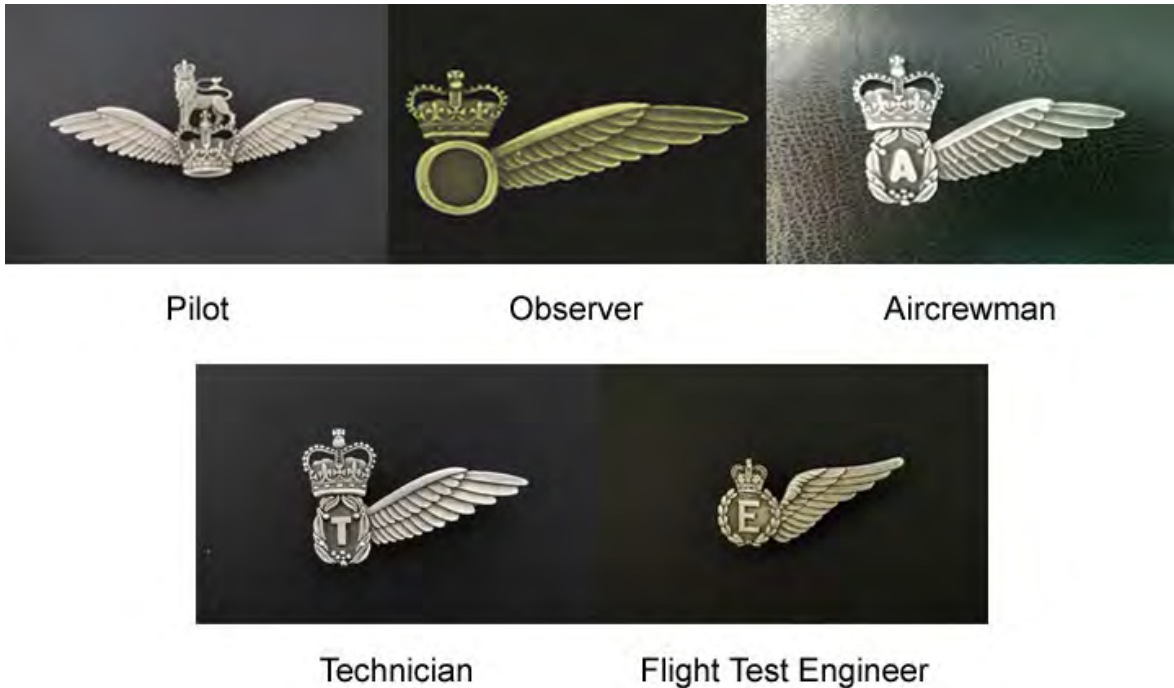

3. Aircrew badges are worn by those personnel qualified as an Army pilot, observer, aircrewman, flight test engineer or technician.
4. A member who has been awarded an aircrew badge by either the Royal Australian Navy (RAN) or Royal Australian Air Force (RAAF), or any of Her Majesty's forces before appointment or enlistment in the Australian Army may, subject to AHQ and advice from Head of Corps (HOC) Australian Army Aviation (AA Avn), wear the equivalent Army badge. During training to qualify as an Army pilot, a person qualified as an RAN or RAAF pilot is to retain the brevet of that Service. A member is not otherwise permitted to wear any aircrew badge other than an Australian Army aircrew badge with the Australian Army uniform.
5. A member qualified in more than one aircrew category, is to wear only one badge; either the badge of the member's current aircrew category or the badge of the member's last aircrew category.

WEARING THE BADGES

6. The items of dress and the type of badge worn on those items of dress are in Table 4A-1. Badges are not worn on any item of dress not listed in the table.

Table 4A-1: Wearing of aircrew badges

| Serial | Dress | Badge |
|--------|--------------------------------|---|
| 1 | Service Dress | Embroidered wings in pale blue and the crest in colour |
| 2 | Shirt Khaki Polyester | Silver metal badge |
| 3 | Safari Jacket | Silver metal badge |
| 4 | Utility Jacket | Embroidered wings in pale blue and the crest in colour |
| 5 | Mess Dress | Officers may purchase bullion badge in miniature size with the wings in silver and the crest in gold and silver |
| 6 | Mess Dress White Jacket | Embroidered full size badge on blue background |
| 7 | Mess Dress Army Jacket | Miniature size silver metal badge |
| 8 | Senior Ranks Mess Dress Jacket | Miniature size silver metal badge |
| 9 | Patrol Blue orders of dress | Embroidered wings in pale blue and the crest in colour |
| 10 | Flying Clothing (AMCU) | Embroidered black on AMCU background |

POSITIONING THE BADGES

7. Aircrew badges are worn with the lower edge of the badge placed centrally, 1 cm above the left breast pocket or 1 cm above the top row of ribbons or medals, as shown in Figure 4A-2.

Figure 4A-2: Positioning aircrew badges

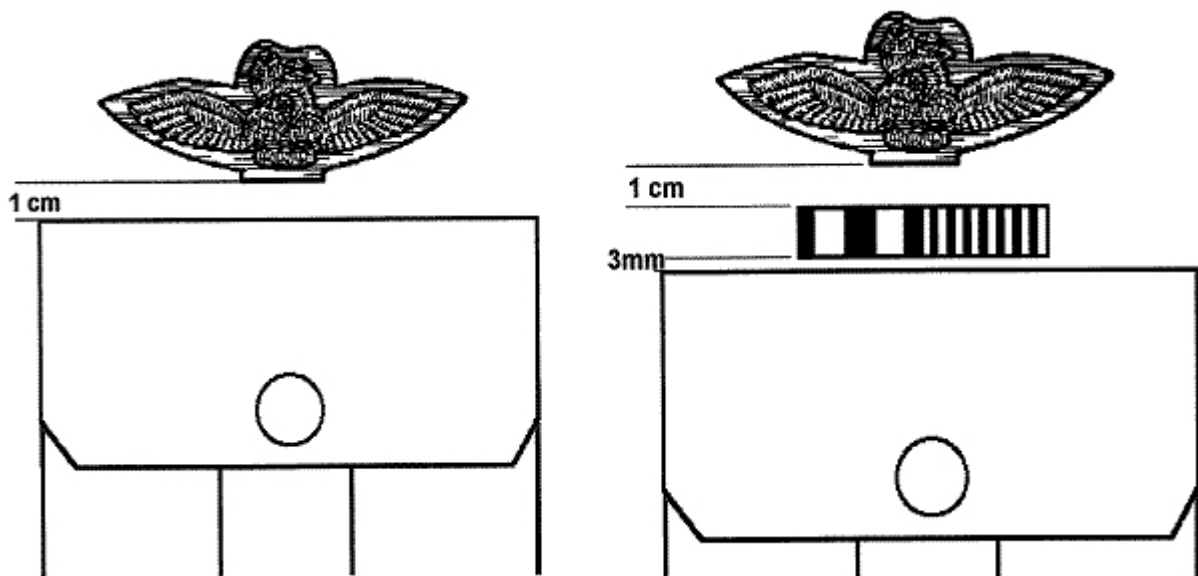

ADM

4A-4

8. The wearing of aircrew badges by officers with Mess Dress is optional. If worn, officers are to wear miniature bullion badges on blue backing or miniature metal badges, according to the type of dress order, purchased by the individual, in accordance with (IAW) Table 4A-1. These badges are positioned, IAW [Annex 5O](#).

ARMY COMBAT BADGE

DESCRIPTION

1. The Army Combat Badge (ACB) is a burnished bronze badge in the form of two crossed swords surrounded by a laurel wreath. The badge is dull in appearance and is not to be polished, as shown in Figure 4B–1.

Figure 4B–1: Army Combat Badge



WEARING THE BADGE

2. The full size ACB is worn with ceremonial and general duty (polyesters) and general duty Service dress orders of dress. The badge is to be worn with the Colour, Banner and AABC Drum Major Sash (if applicable). The miniature badge is worn with mess dress orders of dress. The badge may be worn on the uniform of other uniformed organisations, subject to the approval of those organisations.
3. The wearing of the ACB by entitled members and ex-members of the Australian Army on appropriate occasions, when civilian clothing and medals are worn, is permitted. As such, the ACB may be worn on civilian jackets.
4. The ACB is not worn with Australian Multi-cam Camouflage Uniform (AMCU), Garrison jacket, raincoat, overcoat lightweight or any order of Protective Dress.

POSITIONING THE BADGE

5. The badge is worn with the tips of the swords pointing upwards.
6. The badge is worn on the left breast, placed centrally 1 cm above medal ribbons or medals, as shown in Figure 4B–2.

Figure 4B-2: Army Combat Badge with ribbons

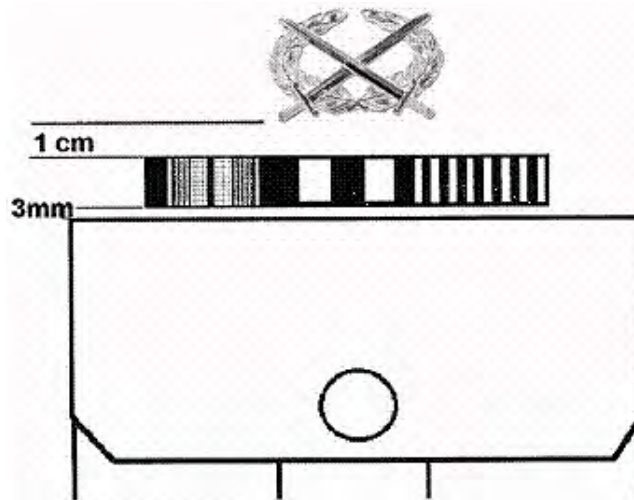

7. If other badges are worn on the left breast, such as aircrew or Parachute Jump Instructor, the ACB is placed 1 cm above the other badge, as shown in Figure 4B-3.

Figure 4B-3: Army Combat Badge with Aircrew Badge

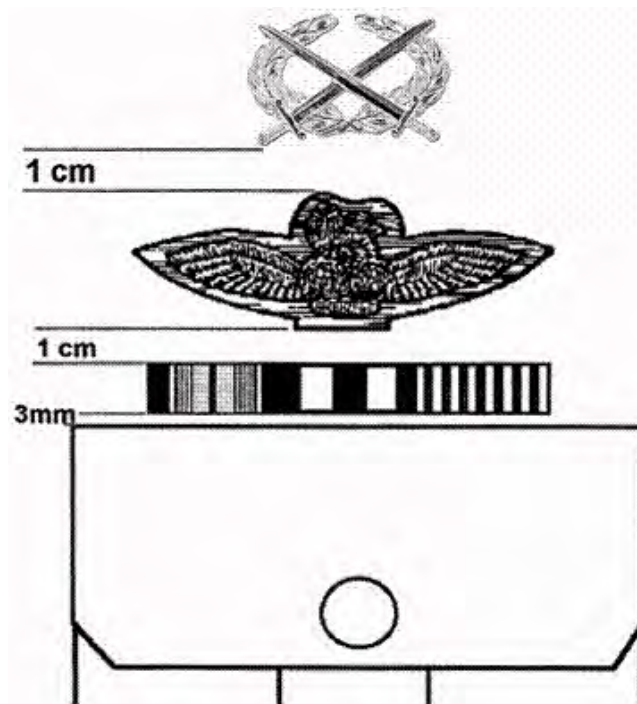

8. The positioning of the miniature ACB worn on mess dress orders of dress is in [Annex 50](#).

9. The full size badge is worn on Patrol Blue orders of dress.

ARMY INDIVIDUAL READINESS NOTIFICATION BADGE

DESCRIPTION

10. The Army Individual Readiness Notification (AIRN) Badge is in Figure 4C–1. The badge is metal and has a bright silver finish.

Figure 4C–1: Army Individual Readiness Notification Badge



ELIGIBILITY

11. The AIRN Badge is worn by personnel who are recorded as having qualified in readiness requirements, in accordance with (IAW) [Defence Instruction \(Army\) Operational 80–1—Army Individual Readiness Notice](#)¹⁷.

WEARING OF THE ARMY INDIVIDUAL READINESS NOTIFICATION BADGE

12. The AIRN Badge is worn with the following orders of dress:
 - a. Ceremonial Parade Dress

¹⁷ http://intranet.defence.gov.au/home/documents/data/ARMYPUBS/DIA/AO80_01.pdf

ADM

4C-2

- b. Ceremonial Dress
- c. General Duty Dress (polyesters)
- d. General Duty Service Dress.

13. The AIRN Badge is not worn on sweater khaki lightweight, Working/Protective Dress, Flying Dress, Disruptive Pattern Camouflage Uniform, Australian Multicam Camouflage Uniform, overcoat, raincoat, Mess Dress or Maternity Dress.

14. The AIRN Badge is not worn on civilian clothing or jackets when medals are worn, and is not to be worn on uniform by retired personnel.

AUSTRALIAN BADGE

- 15. Only an Australian Army AIRN badge is to be worn on Army uniforms.

POSITIONING THE ARMY INDIVIDUAL READINESS NOTIFICATION BADGE

16. The AIRN Badge is worn above the right breast pocket, below emblems of unit citations and individual Service commendation badges or medallions. The AIRN Badge is positioned, IAW Figure 4C-2.

Figure 4C-2: Positioning the Army Individual Readiness Notification Badge

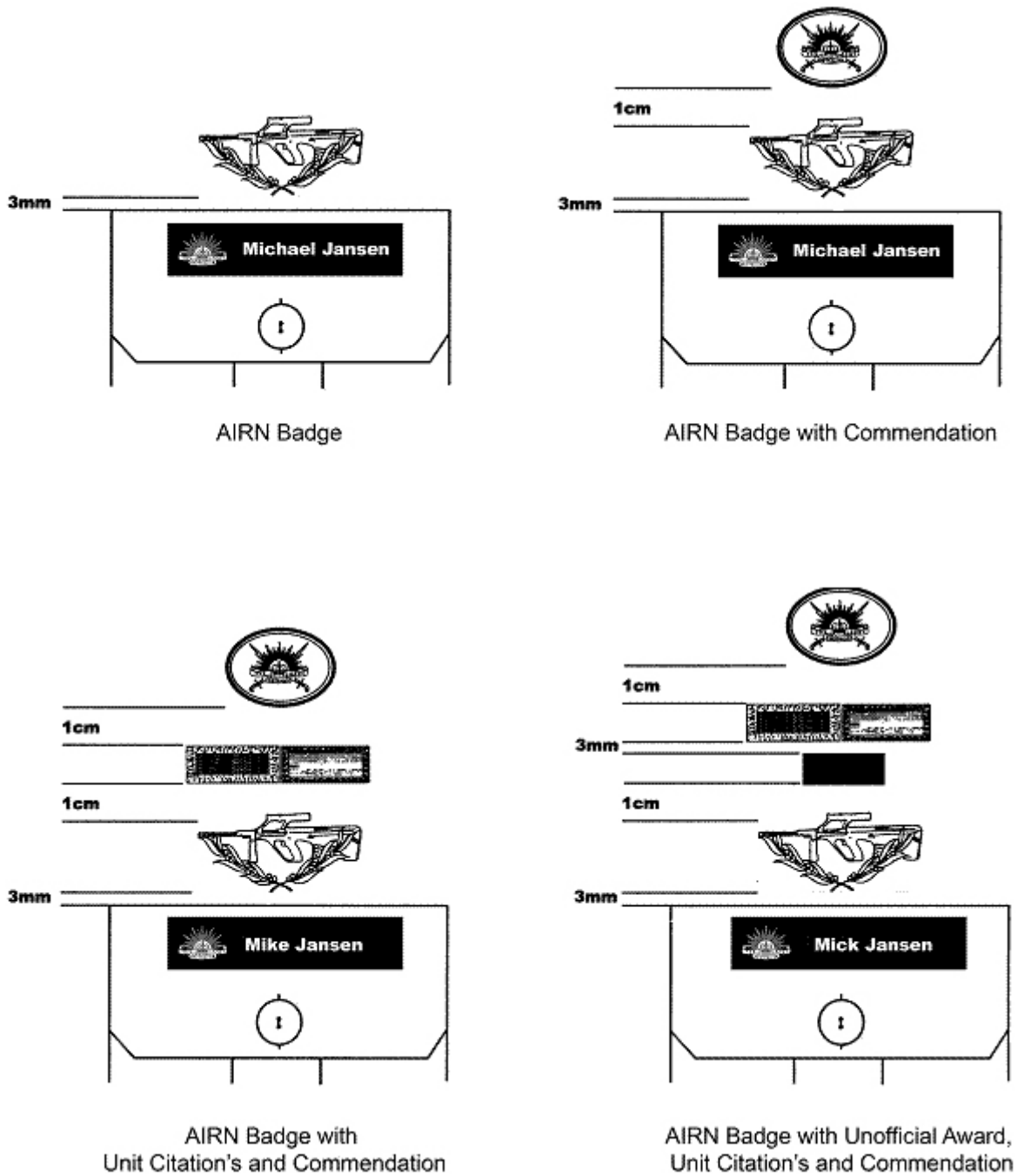

CORPS/REGIMENT BADGE

HAT AND CAP BADGES

17. Corps/Regiment hat and cap badges are worn by all personnel, except Senior officers (COL and above), not serving in Corps appointments, and those selected personnel in [Chapter 1](#) who wear the Australian Army Rising Sun Badge in lieu of Corps/Regiment badges. Hat and cap badges are worn on the Ceremonial Hat Khaki Fur Felt (KFF), Blue Service cap and the beret. Royal Australian Artillery (RAA) members are to wear the miniature RAA hat badge in lieu of the large RAA hat badge when wearing the beret. Only RAA officers may wear the coloured embroidered cloth hat badge on the beret in lieu of the metal hat badge.

18. On the front the Hat KFF, cap and beret, Tier C Regimental Sergeant Major (RSM) appointments wear a hat badge depicting the Australian Coat of Arms in lieu of Corps/Regiment badges. The Regimental Sergeant Major – Army (RSM–A) wears the distinctive Australian Coat of Arms badge surrounded by a wreath.

COLLAR BADGES

19. In most cases, the Corps/Regiment collar badges are the miniature versions of the Corps/Regiment hat badge. Collar badges are worn by eligible personnel with Service Dress and Mess Dress. Personnel in special appointments who are entitled to wear Patrol Blue White Jacket uniforms wear Corps/Regiment collar badges on those orders of dress. All current authorised hat and collar badges in their order of precedence are in [Appendix 4D1](#).

Royal Australian Artillery, Royal Australian Engineers and Royal Australian Army Chaplain Department collar badges

20. There are two different designs for RAA, RAE and RAA Ch D collar badges.

- a. **Royal Australian Artillery.** RAA officers and WO1s are to wear the distinctive 'gunners' grenade collar badge which has seven flames in Figure 4D–1. RAA WO2 and below rank are to wear the RAA Scroll collar badge in Figure 4D–2.

Figure 4D-1: Royal Australian Artillery Officers and WO1 collar badge



Figure 4D-2: Royal Australian Artillery WO2 and below rank collar badge



- b. **Royal Australian Engineers.** RAE officers and WO1s are to wear the distinctive 'sappers' grenade collar badge which has nine flames in Figure 4D-3. RAE WO2 and below rank are to wear the 3 cm miniature version of the 'sappers' grenade collar badge which has nine flames in Figure 4D-4.

Figure 4D-3: Royal Australian Engineers Officers and WO1 collar badge



Figure 4D-4: Royal Australian Engineer WO2 and below rank collar badge



- c. RAA Ch D. RAA Ch D chaplains are to wear either a gold metal cross, Christian or Star of David–Jewish collar badges, IAW [Annex 5F](#).

Regimental Sergeant Major – Army, Tier C Regimental Sergeant Majors and Australian Federal Guard collar badges

21. The RSM–A, Tier C RSMs and Army component of the Australian Federation Guard (AFG) are to wear the 4 cm miniature Australian Army Rising Sun collar badge in Figure 4D-5.

Figure 4D-5: Regimental Sergeant Major – Army, Tier C Regimental Sergeant Major and Australian Federal Guard collar badge



POSITIONING OF BADGES ON HEADRESS

22. Corps/Regiment badges are positioned on headdress as follows:
 - a. **Hat Khaki Fur Felt.** The badge is positioned centrally on the front of the puggaree with the lowest point of the badge touching the brim of the hat.
 - b. **Blue Service cap.** The badge is positioned centrally on the front of the cap with the lowest point of the badge 1 cm above the chinstrap.
 - c. **Beret.** The badge is positioned centrally on the backing provided with the lower edge 1 cm above the band. The beret is worn so that the badge is positioned vertically over the left eye.
23. Badge positions on all forms of headdress are in Figure 4D-6.

Figure 4D-6: Positioning the badges on headdress



a. Hat KFF

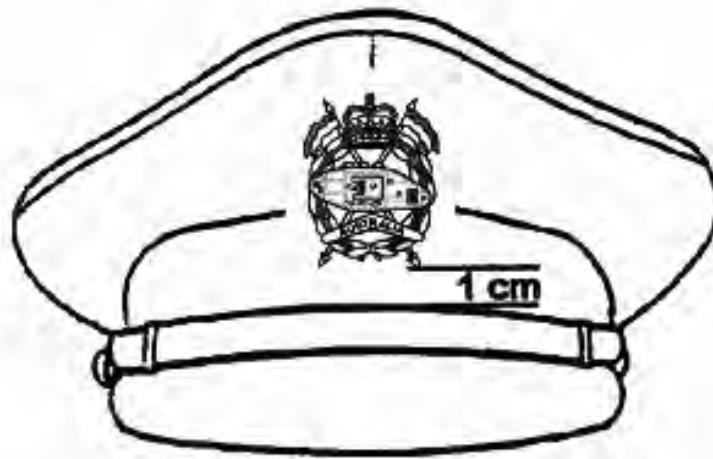

b. Blue Service Cap

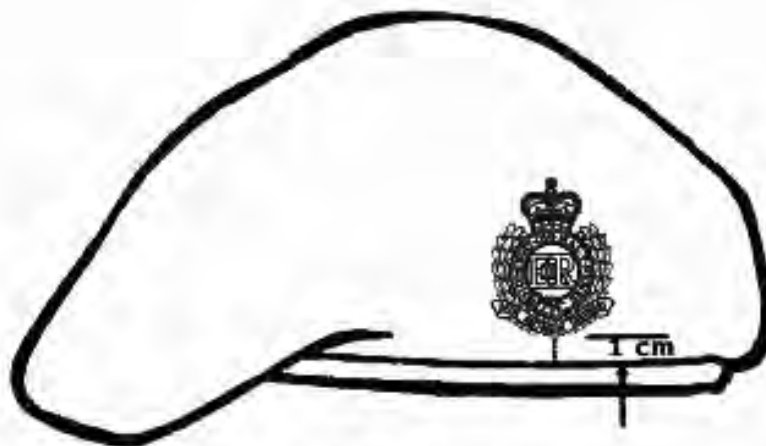

c. Beret

Collar badges

24. Paired badges are worn facing inwards, except the Pilbara Regiment and 1 Avn Regt who are authorised to wear the badges facing out. This normally has the badge which is the miniature of the hat or cap badge worn on the left lapel. Collar badges are positioned as follows:

- a. **Service Dress.** Collar badges are positioned vertically with the lowest point of the badge on the horizontal line, joining the tips of the lower edge of the collar and centrally between the tip of the collar, and the inner edge of the lapel, as shown in Figure 4D-7.
 - b. **Patrol Blue orders of dress.** Collar badges are positioned midway between the top and bottom of the collar so that the centre of the badge is 5–5.5 cm from the end of the collar, as shown in Figure 4D-8. The badges should appear upright when viewed from the front. The officers badges of the RAA and RAE which are too large to be worn vertically are to be worn horizontally so that the base of the badges is nearest the collar end, as shown in Figure 4D-9.
25. The positioning of collar badges with mess jackets is in [Annex 5O](#).

Figure 4D-7: Positioning the collar badge on Service Dress

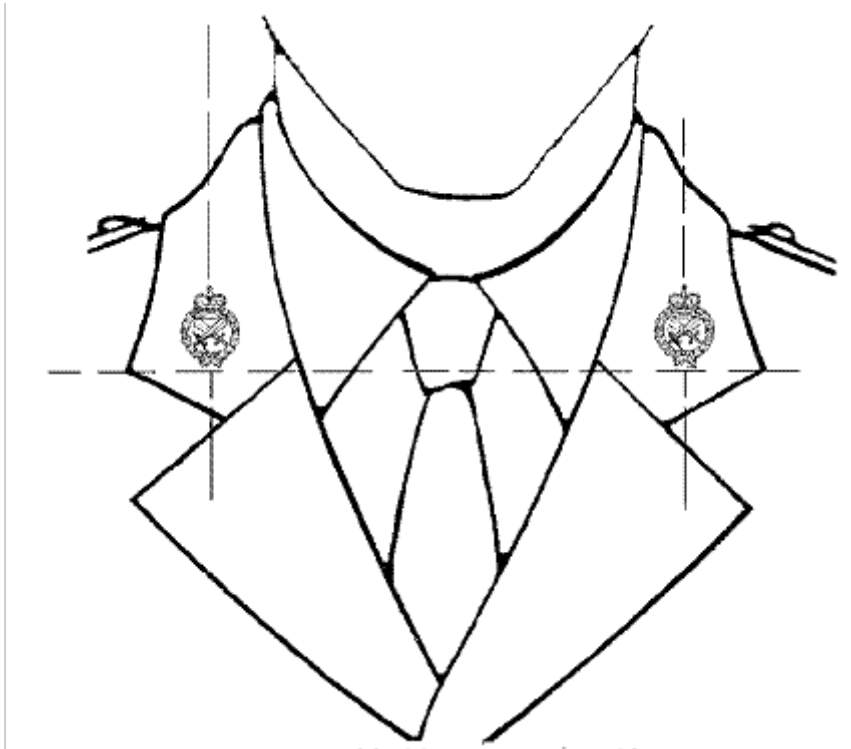

Figure 4D-8: Positioning the collar badge on Patrol Blue orders of dress

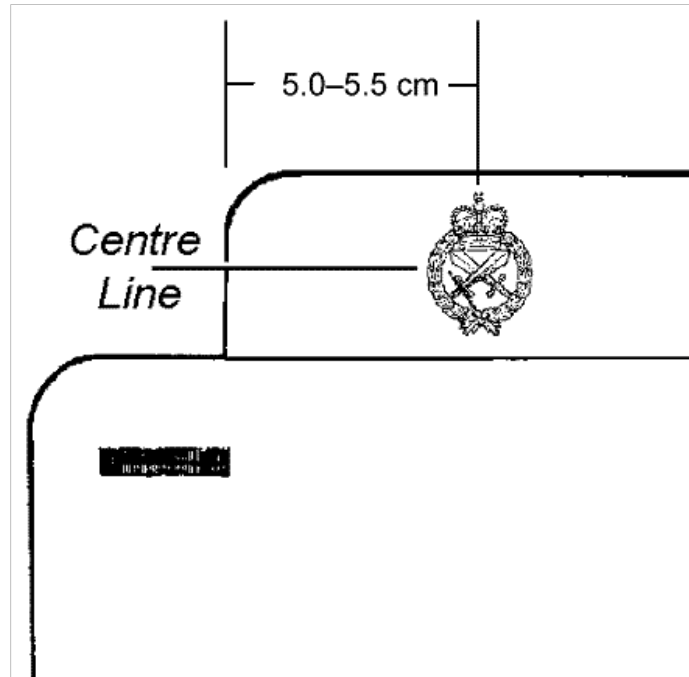
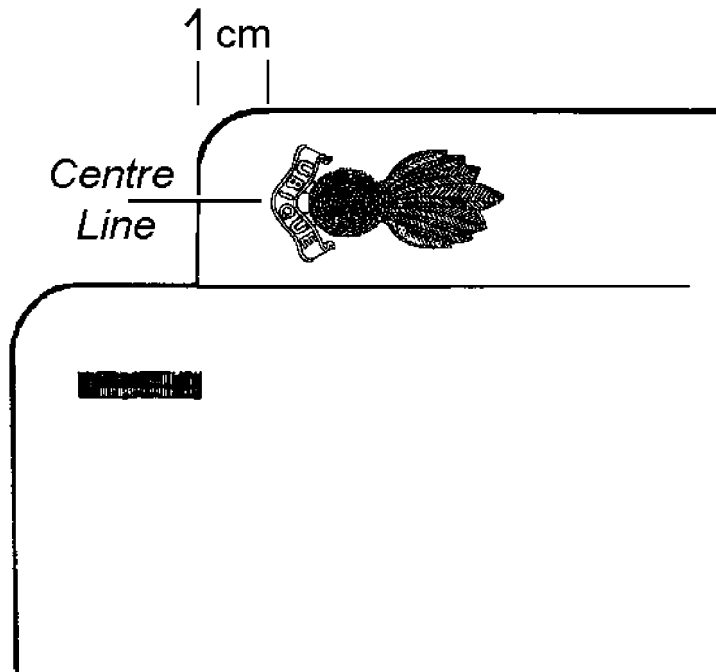

Figure 4D-9: Positioning the Royal Australian Artillery and Royal Australian Engineer badges on Patrol Blue orders of dress



Royal Australian Artillery collar badge shown









Appendix:

4D1 [Corps and regimental hat badges of the Australian Army](#)

CORPS AND REGIMENTAL HAT BADGES OF THE AUSTRALIAN ARMY

CORPS

| | | |
|---|---|---|
| ROYAL MILITARY COLLEGE (CORPS OF STAFF CADETS) | ROYAL AUSTRALIAN ARMoured CORPS | ROYAL REGIMENT OF AUSTRALIAN ARTILLERY |
|  |  |  |
| ROYAL AUSTRALIAN ENGINEERS | ROYAL AUSTRALIAN CORPS OF SIGNALS | ROYAL AUSTRALIAN INFANTRY CORPS |
|  |  |  |
| AUSTRALIAN ARMY AVIATION CORPS | AUSTRALIAN INTELLIGENCE CORPS | ROYAL AUSTRALIAN ARMY CHAPLAINS DEPARTMENT (CHRISTIAN) |
|  |  |  |









| | | |
|---|---|---|
| ROYAL AUSTRALIAN ARMY CHAPLAINS DEPARTMENT (JEWISH) | ROYAL AUSTRALIAN CORPS OF TRANSPORT | ROYAL AUSTRALIAN ARMY MEDICAL CORPS |
|  |  |  |
| ROYAL AUSTRALIAN ARMY DENTAL CORPS | ROYAL AUSTRALIAN ARMY ORDNANCE CORPS | ROYAL AUSTRALIAN ELECTRICAL AND MECHANICAL ENGINEERS |
|  |  |  |
| ROYAL AUSTRALIAN ARMY EDUCATION CORPS | AUSTRALIAN ARMY PUBLIC RELATIONS SERVICE | AUSTRALIAN ARMY CATERING CORPS |
|  |  |  |

| | | |
|---|--|--|
| ROYAL AUSTRALIAN ARMY PAY CORPS | AUSTRALIAN ARMY LEGAL CORPS | ROYAL AUSTRALIAN CORPS OF MILITARY POLICE |
|  |  |  |
| AUSTRALIAN ARMY PSYCHOLOGY CORPS | AUSTRALIAN ARMY BAND CORPS | ROYAL AUSTRALIAN ARMY NURSING CORPS |
|  |  |  |
| AUSTRALIAN ARMY CADETS | | |
|  | | |

REGIMENTAL (ARMoured)



| | | |
|---|---|---|
| 1ST ARMoured REGIMENT | 2ND CAVALRY REGIMENT | 3RD/4TH CAVALRY REGIMENT |
|  |  |  |
| 1ST/15TH ROYAL NEW SOUTH WALES LANCERS | 2ND/14TH LIGHT HORSE REGIMENT (QUEENSLAND MOUNTED INFANTRY) | 3RD/9TH LIGHT HORSE REGIMENT (SOUTH AUSTRALIAN MOUNTED RIFLES) |
|  |  |  |
| 4TH/19TH PRINCE OF WALES'S LIGHT HORSE | 10TH LIGHT HORSE REGIMENT | 12TH/16TH HUNTER RIVER LANCERS |
|  |  |  |

REGIMENTAL (INFANTRY)



| | | |
|---|---|---|
| THE ROYAL AUSTRALIAN REGIMENT | THE ROYAL QUEENSLAND REGIMENT | THE ROYAL NEW SOUTH WALES REGIMENT |
|  |  |  |
| THE ROYAL VICTORIA REGIMENT | THE ROYAL SOUTH AUSTRALIA REGIMENT | THE ROYAL WESTERN AUSTRALIA REGIMENT |
|  |  |  |
| THE ROYAL TASMANIA REGIMENT | THE PILBARA REGIMENT | 51ST BATTALION, THE FAR NORTH QUEENSLAND REGIMENT |
|  |  |  |

| | | |
|---|--|--|
| NORTH WEST MOBILE FORCE | QUEENSLAND UNIVERSITY REGIMENT | MELBOURNE UNIVERSITY REGIMENT (worn with green felt backing) |
|  |  |  |
| SYDNEY UNIVERSITY REGIMENT | UNIVERSITY OF NEW SOUTH WALES REGIMENT | ADELAIDE UNIVERSITIES REGIMENT |
|  |  |  |
| WESTERN AUSTRALIAN UNIVERSITY REGIMENT | | |
|  | | |

REGIMENTAL (SPECIAL OPERATIONS COMMAND)

| | | |
|--|--|---|
| SPECIAL AIR SERVICE REGIMENT | 1ST COMMANDO REGIMENT | 2ND COMMANDO REGIMENT |
|  |  |  |
| SPECIAL OPERATIONS ENGINEER REGIMENT | SPECIAL OPERATIONS LOGISTIC SQUADRON | |
|  |  | |

REGIMENTAL (AVIATION)

| | | |
|---|---|---|
| 1ST AVIATION REGIMENT | 5TH AVIATION REGIMENT | 6TH AVIATION REGIMENT |
|  |  |  |

INFANTRY COMBAT BADGE

DESCRIPTION

1. The Infantry Combat Badge (ICB) is a bronze badge which consists of a wreath surrounding a bayonet, as shown in Figure 4E–1. The badge is dull in appearance and is not to be polished.

Figure 4E–1: Infantry Combat Badge



WEARING THE BADGE

2. The full size ICB is worn with ceremonial and general duty (polyesters), general duty Service dress orders of dress. The badge is to be worn with the Colour, Banner or AABC Drum Major Sash (if applicable). The miniature badge is worn with mess dress orders of dress. The badge may be worn on the uniform of other uniformed organisations, subject to the approval of those organisations.
3. The wearing of the ICB by entitled members and ex-members of the Australian Army on appropriate occasions, when civilian clothing and medals are worn, is permitted. As such, the ICB may be worn on civilian jackets.

ADM

4E-2

4. The ICB is not worn with Australian Multi-cam Camouflage Uniform, Garrison jacket, raincoat, overcoat lightweight or any order of Protective Dress.

POSITIONING THE BADGE

5. The badge is worn with the bayonet pointing upwards.

6. The badge is worn on the left breast, placed centrally 1 cm above medal ribbons or medals, as shown in Figure 4E-2.

Figure 4E-2: Infantry Combat Badge with ribbons

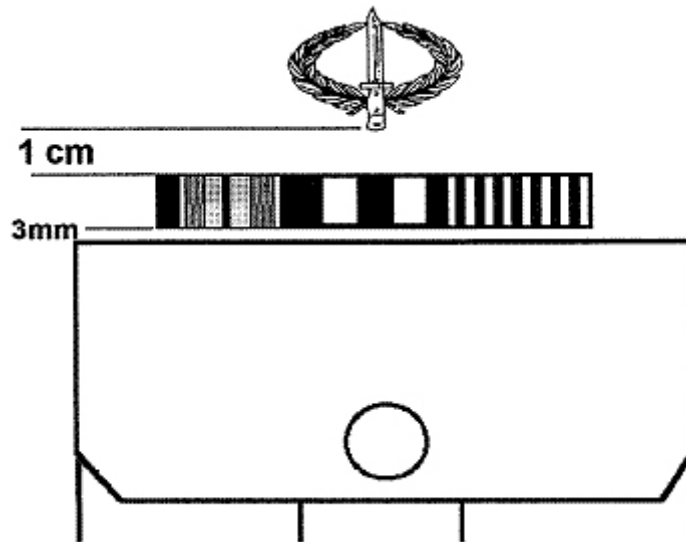

7. If other badges are worn on the left breast, such as aircrew or Parachute Jump Instructor, the ICB is placed 1 cm above the other badge, as shown in Figure 4E-3.

Figure 4E-3: Infantry Combat Badge with Parachute Jump Instructor Badge

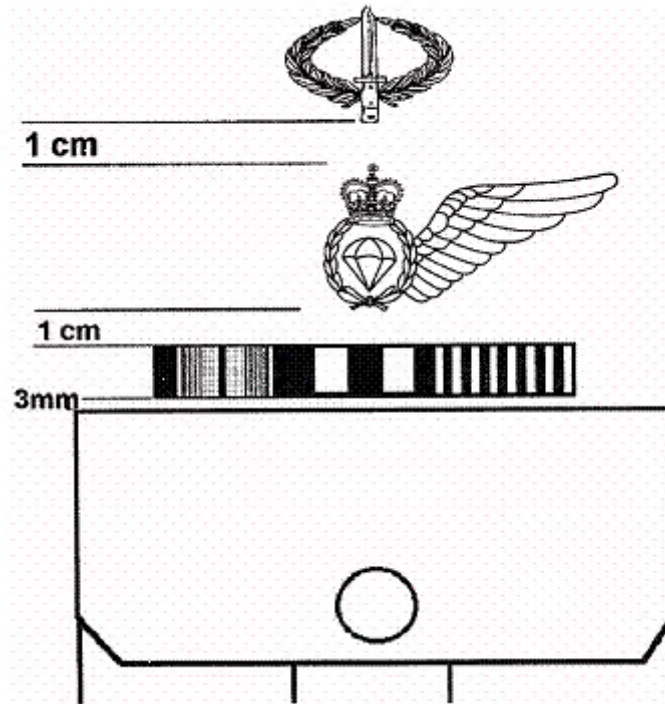

8. The positioning of the miniature ICB worn on mess dress orders of dress is in [Annex 5O](#).
9. The full size badge is worn on Patrol Blue orders of dress.

MILITARY INSTRUCTOR BADGE

DESCRIPTION

10. The Military Instructor Badge (MIB) is a metal, silver badge. The badge consists of a shield with the letters 'MI' and the wordings 'MILITARY INSTRUCTOR' and 'STRIVE FOR EXCELLENCE' contained within the shield. It is surrounded by a wreath over a scroll bearing the title 'ARMY', as shown in Figure 4F-1. It is dull in colour and is not to be polished.

Figure 4F-1: Military Instructor Badge



WEARING THE BADGE

11. The MIB is worn with ceremonial and general duty orders of dress. With General Duty Dress (AMCU), the MIB is worn only on the training establishment identification arm patch, on the right sleeve of the AMCU shirt.
12. The MIB is only worn by entitled members who have maintained their particular instructional and assessment competencies over a prescribed period of time, IAW the IADP, regardless of their posted Command.
13. The MIB is not to be worn in conjunction with the Recruit Instructor Badge (RIB). The MIB is not worn with Mess Dress, Garrison jacket, raincoat, overcoat lightweight or any order of Protective Dress.

AUSTRALIAN BADGE

- 14. Only an Australian Army MIB is to be worn on Army uniform.

POSITIONING THE BADGE

15. When worn with authorised dress, the MIB is worn on the lower left corner of the flap of the right breast pocket, midway between the button and edge of the pocket, with the base of the badge positioned 3 mm above the bottom edge of the pocket, as shown in Figure 4F-2. When worn on the training establishment identification arm patch, it is positioned centrally on the patch, as shown in Figure 4F-3.

Figure 4F-2: Positioning the Military Instructor Badge

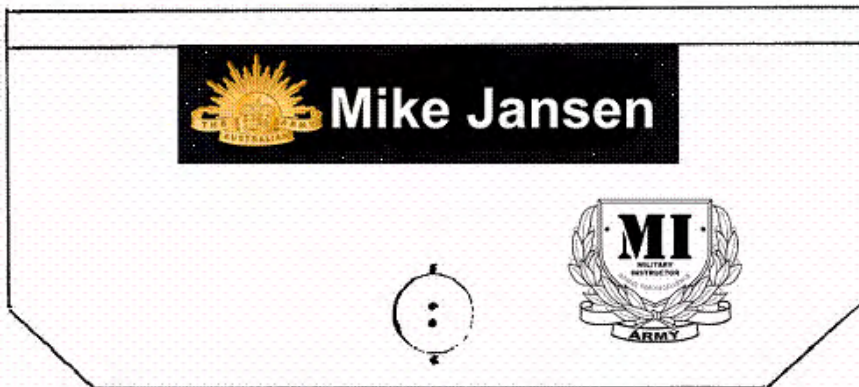

Figure 4F-3: Positioning the Military Instructor Badge worn on Training Establishment Identification Arm Patch on General Duty (Australian Multi-cam Camouflage Uniform)



PARACHUTE BADGES

DESCRIPTION

1. A Parachute qualification badges are authorised for the following categories:
 - a. Basic Paratrooper
 - b. Special Air Service Regiment (SASR)
 - c. Commando – 1 Cdo Regt, 2 Cdo Regt
 - d. 3 Royal Australian Regiment (RAR) (until current stock holding run-out).
2. The design of these badges is as follows:
 - a. Basic Paratrooper – embroidered white parachute with pale blue wings on a khaki, blue/black, scarlet or white background which is dependent on the garment to be worn.
 - b. SASR – embroidered white parachute with blue/pale blue wings on a blue/black background.
 - c. Commando – embroidered black parachute and wings on a Sherwood green background.
 - d. 3 RAR – embroidered pale blue parachute and wings on a maroon background (until current stock holding run-out).
3. Members who have qualified as a paratrooper after 26 September 2011 are not authorised to wear the 3 RAR parachute badge; those members are to wear the Basic Paratrooper badge. Members who were or are posted to 'A' Bty, Royal Australian Artillery (RAA) and have previously qualified to wear the 3 RAR parachute badge may continue to wear the badge until current stock holdings run-out, or until transition from the Army. Those 'A' Bty, RAA are only permitted to wear the badge, if they have been authorised by routine order from Commanding Officer (CO), 3 RAR to do so.
4. The gold brevet is authorised to be worn by personnel who have both the Free Fall Instructor (FFI) and Parachute Jump Instructor (PJI) qualification. The silver brevet is authorised to be worn by personnel who have either the FFI or PJI qualification. The bronze brevet is authorised to be worn by personnel who have either the Parachute Jump Master Static Line (PJMSL) or the Parachute Jump Master Free Fall (PJMFF) qualification:
 - a. PJMSL and/or PJMFF – a bronze metal parachute and half wing surmounted by a crown with pins and clutch grips. Full and miniature size gold bullion embroidered parachute and half wing on black background.

ADM

4G-2

- b. PJI or FFI – a silver metal parachute and half wing surmounted by a crown with pins and clutch grips. Full and miniature size gold bullion embroidered parachute and half wing on black background with silver embossing on the border of the badge.
- c. PJI and FFI – a gold metal parachute and half wing surmounted by a crown with pins and clutch grips. Full and miniature size gold bullion embroidered parachute and half wing on black background with gold embossing on the border of the badge.
- d. The wearing of parachute badges is to be worn with the items of dress as directed in Table 4G-1.
- 5. The badges are in Figure 4G-1.

Figure 4G-1: Parachute and Parachute Instructor Badges



ELIGIBILITY

6. Eligibility for wearing the various categories of parachute badge is as follows:
 - a. Basic Paratrooper – a member qualified as a basic paratrooper; and in accordance with (IAW) paragraph 3 to this annex.
 - b. SASR – a qualified member or ex-member of SASR who has qualified as a basic paratrooper.
 - c. Commando – a qualified member or ex-member of the former 4 RAR, 2 Cdo Regt or 1 Cdo Regt who has qualified as a basic paratrooper.
 - d. 3 RAR – a member or ex-member of 3 RAR and 'A' Bty, RAA who has qualified as a basic paratrooper (until current stock holding run-out); and IAW paragraph 3 to this annex.
 - e. FFI, PJI and PJM – a member who has qualified in these categories at the PTS.

WEARING OF PARACHUTE BADGES WITH ITEMS OF DRESS

7. The type of parachute badge to be worn with each item of dress is in Table 4G-1.

Table 4G-1: Wearing of parachute badges

| Serial | Dress | Parachute Badge | FFI, PJI, PJM Badge | Remarks |
|--------|-------------------------|---------------------------------------|--|---------|
| 1 | Service Dress | One of the four badges in paragraph 2 | Gold, silver or bronze metal with pins and clutch grips at paragraph 4 | |
| 2 | Shirt polyester | One of the four badges in paragraph 2 | Gold, silver or bronze metal with pins and clutch grips at paragraph 4 | |
| 3 | Safari Jacket | One of the four badges in paragraph 2 | Gold, silver or bronze metal with pins and clutch grips at paragraph 4 | |
| 4 | Utility Jacket | One of the four badges in paragraph 2 | Gold, silver or bronze metal with pins and clutch grips at paragraph 4 | |
| 5 | Mess Dress Jacket | One of the four badges in paragraph 2 | Embroidered miniature gold bullion badge at paragraph 4 | |
| 6 | Mess Dress White Jacket | One of the four badges in paragraph 2 | Embroidered miniature gold bullion badge at paragraph 4 | |

| Serial | Dress | Parachute Badge | FFI, PJI, PJM Badge | Remarks |
|---------------|-----------------------------|--|---|-------------------------------|
| 7 | Mess Dress Army | One of the four badges in paragraph 2 | Embroidered miniature gold bullion badge at paragraph 4 | |
| 8 | Senior Ranks Mess Dress | One of the four badges in paragraph 2 | Miniature size metal gold, silver or bronze badge | |
| 9 | Patrol Blue orders of dress | One of the four badges in paragraph 2 | Embroidered gold bullion badge at paragraph 4 | |
| 10 | Para Smock | One of the four badges listed in paragraph 2 but embroidered black on AMCU backing | Embroidered black on a AMCU backing | Purchased at members' expense |

SPECIAL CONDITIONS

8. Only one parachute badge is to be worn on the sleeve. A FFI, PJI or PJM brevet is to be worn in conjunction with one of the paratrooper badges, but not with an aircrew badge.
9. A member qualified as a basic paratrooper is to wear:
 - a. If qualified SASR – the SASR Parachute Badge.
 - b. If qualified either 1 Cdo Regt or 2 Cdo Regt – the Commando Parachute Badge.
 - c. If qualified and posted to 3 RAR or 'A' Bty, RAA – the 3 RAR Parachute Badge (until current stock holding run-out); and IAW paragraph 3 to this annex.
 - d. If posted from one airborne unit to another – the member is to wear the parachute badge of the unit that the member is currently serving in, provided the member meets the unit's eligibility requirements, IAW paragraph 6 to this annex, otherwise paragraph 9(e) to this annex applies.
 - e. If posted to any other unit – whichever parachute badge that the member is qualified in and prefers to wear.

AUSTRALIAN BADGE

- 10. Only an Australian Army parachute badge is to be worn on Army uniforms.

POSITIONING OF THE PARACHUTE BADGES

11. Parachute badges are worn on the right sleeve of Australian Army uniforms, IAW Table 4G-1 and Figure 4G-2.

12. The FFI, PJI or PJM brevet is worn with the lower edge of the badge with the parachute placed centrally, 1 cm above the left breast pocket or 1 cm above the top row of ribbons or medals, in the same manner as for aircrew badges, IAW [Annex 4A](#).

13. With Mess Dress Jacket, officers and ORs wear the miniature form of the FFI, PJI or PJM brevet on the left lapel. The wearing of the FFI, PJI or PJM brevet by officers with Mess Dress is optional. If worn, officers are to wear a miniature bullion badge on blue/black backing, purchased by the members' expense. Miniature metal badges are to be worn with Mess Dress Army and Senior Ranks Mess Dress. The badge is positioned, IAW [Annex 5O](#).

Figure 4G-2: Positioning the Parachute Badge

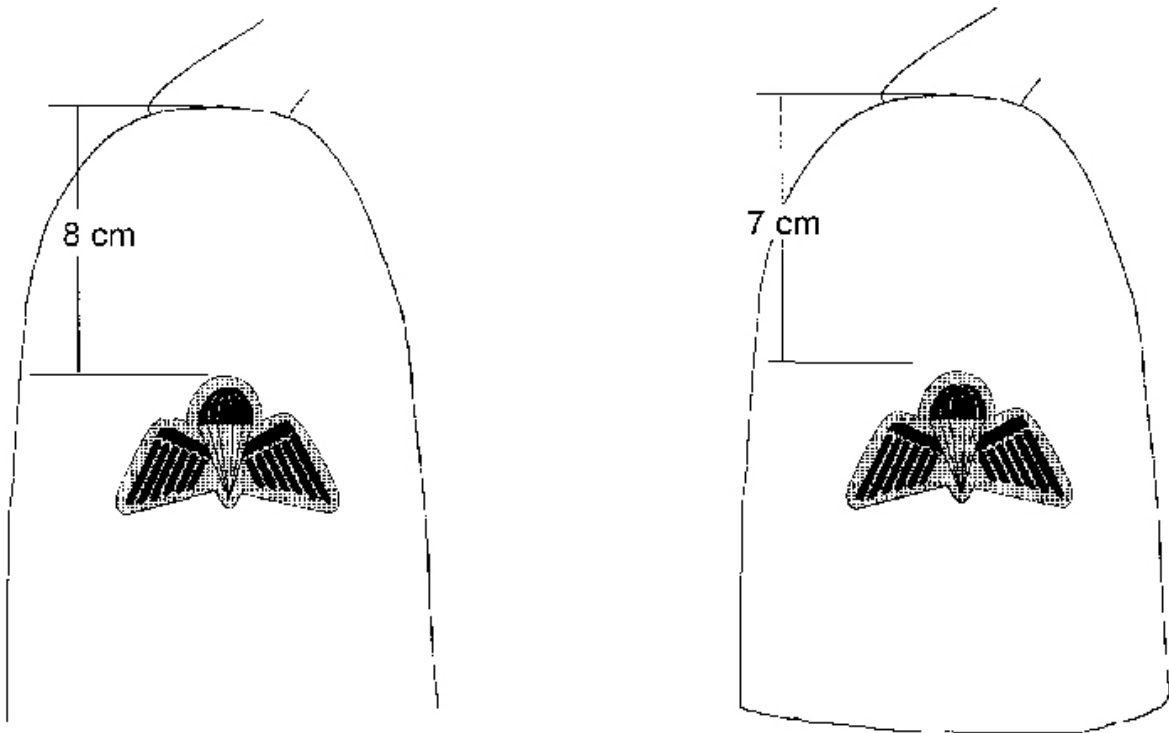

a. Service Dress Jacket and Utility Jacket

b. Short Sleeve Shirt and Safari Suit Jacket

RANK BADGES AND INSIGNIA

OFFICER DESCRIPTION

1. Army officer badges of rank, including the Governor-General and State Governors, are in [Appendix 4H1](#). Metal rank insignia are produced in gold, silver or black finish according to the Corps/Regiment.
2. 51 FNQR officers (LT–LTCOL) are to wear black metal rank insignia when wearing ceremonial and mess dress orders of dress, and black embroidered rank insignia when wearing General Duty Dress (polyesters) and Utility jacket.
3. SUR officers (LT–COL) are to wear the black metal rank insignia on scarlet backing when wearing ceremonial and mess dress orders of dress, and black embroidered rank insignia on scarlet backing when wearing General Duty Dress (polyesters) and Utility jacket.
4. Silver insignia are worn by Royal Australian Armoured Corps (RAAC), Australian Army Aviation (AA Avn) and Royal Australian Army Nursing Corps (RAANC) personnel.
5. All other Corps wear the gold coloured rank insignia.
6. Rank slides are produced with gold/silver/black embroidered on khaki polyester material and black on Australian Multi-cam Camouflage Uniform (AMCU) material.

WEARING OFFICER BADGES OF RANK

7. Officer badges of rank are worn on both shoulders, except AMCU and the Garrison jacket. The badges for General officers are worn in left and right sets with the point of the sword facing the front on each side. Badges of rank are worn as follows:
 - a. Service Dress – metal insignia fixed directly to epaulettes.
 - b. Polyester shirt:
 - (1) Ceremonial – metal insignia on khaki shoulder boards.
 - (2) General Duty – embroidered on khaki shoulder slides.
 - c. Utility jacket – embroidered on khaki shoulder slides.
 - d. Safari Suit jacket – metal insignia fixed directly to epaulettes.
 - e. Overcoat Extreme Cold Weather – metal insignia fixed directly to epaulettes.

- f. Mess Dress:
- (1) Mess Dress – metal insignia fixed directly to epaulettes. Senior officers, COL and above, wear bullion badges of rank.
 - (2) Mess Dress White Jacket – metal insignia fixed directly to epaulettes.
 - (3) Mess Dress Army – metal insignia pinned to black curved shoulder boards
 - (4) Senior Ranks Mess Dress – metal insignia pinned to black curved shoulder boards.
- g. Patrol Blue orders of dress – metal badges of rank with wire prongs fixed to shoulder cords. Gold insignia are worn on silver cords and silver insignia are worn on gold cords.
- h. General Duty Dress (AMCU)/Field Dress (AMCU) – black embroidered rank on an AMCU rank slide with black embroidered 'AUSTRALIA' title.
- i. General Purpose Jacket – black embroidered rank on an AMCU rank slide with black embroidered 'AUSTRALIA' title.
- j. Garrison jacket – embroidered khaki brown rank slide.
8. Badges of rank are not worn on raincoat or overcoat lightweight.

POSITIONING OF OFFICER RANK BADGES

9. The order of placement from the point of the shoulder towards the neck is:
- a. metal shoulder titles, and/or
 - b. Royal Cypher and Crown
 - c. badges of rank.
10. Metal insignia is positioned on shoulder straps/boards/epaulettes, in accordance with (IAW) Figure 4H-1. The spacing may need to be adjusted on small shoulder straps/boards/epaulettes or when other insignia, such as Royal Cypher and Crown are worn. The position of rank badges on shoulder cords is in [Chapter 3](#).

Figure 4H-1: Positioning the Officer Badges of Rank

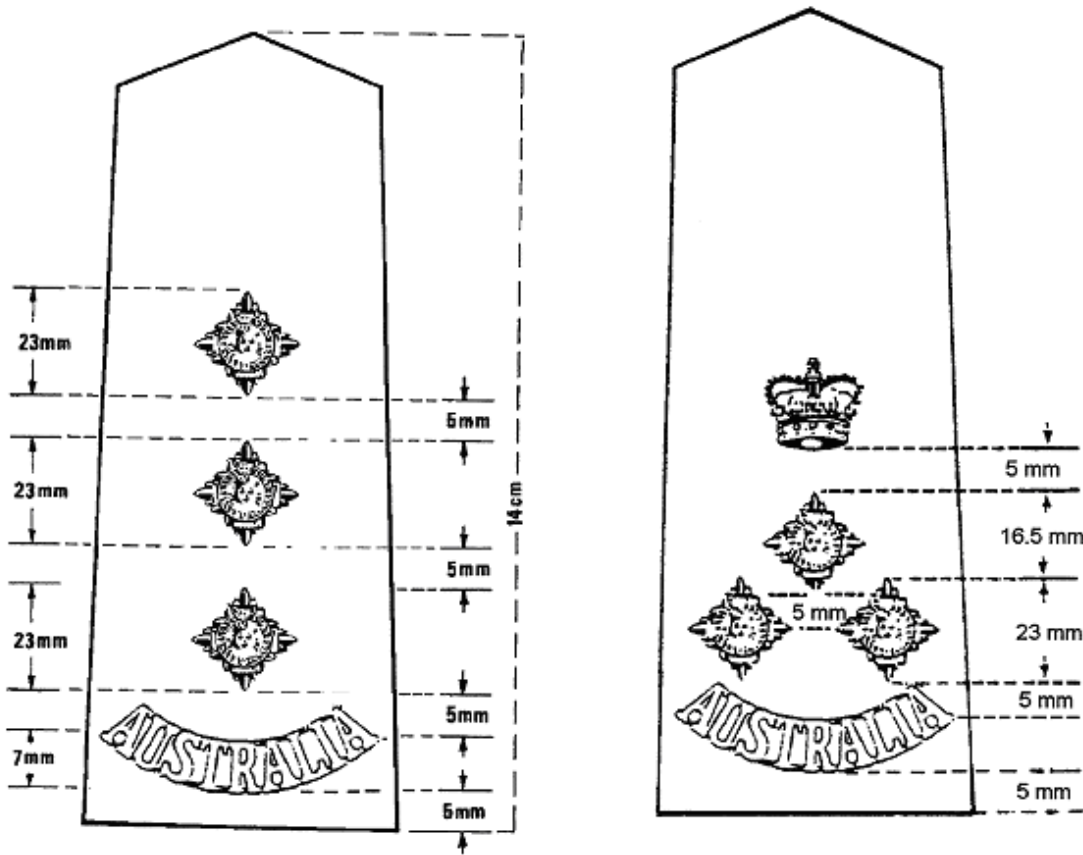

a. Officer Insignia

b. Brigadier

WARRANT OFFICER DESCRIPTION

11. Warrant Officer (WO) badges of rank are in [Appendix 4H1](#). Badges are produced as embroidered badges in full colour or black.
12. 51 FNQR WOs are to wear black rank insignia on khaki backing with ceremonial, General Duty Dress (polyesters) and Utility jacket; and black rank insignia on white backing with Mess Dress White Jacket.
13. SUR WOs are to wear black rank insignia on scarlet backing.
14. Silver coloured embroidered rank insignia is worn by RAAC, AA Avn and RAANC personnel.
15. All other Corps are to wear the gold coloured embroidered rank insignia.

WEARING OF WARRANT OFFICER BADGES OF RANK

16. WO badges of rank are worn as follows:
 - a. Service Dress – large embroidered badge on khaki backing (curved shape).
 - b. Polyester shirt – small embroidered badge on khaki backing (square).
 - c. Utility jacket – large embroidered badge on khaki backing (curved shape).
 - d. Overcoat extreme cold weather—large embroidered badge on khaki backing (curved shape).
 - e. Mess Dress:
 - (1) Mess Dress Army – WO1 metal insignia fixed directly to black curved shoulder board and WO2 embroidered gold insignia on black curved shoulder boards.
 - (2) Mess Dress White Jacket – large embroidered badge on white backing (curved shape).
 - f. Patrol Blue orders of dress – large embroidered badge on blue or white backing (curved shape).
 - g. General Duty Dress (AMCU)/Field Dress (AMCU) – black embroidered rank on an AMCU rank slide with black embroidered 'AUSTRALIA' title.
 - h. Working/Protective Dress – DPCU rank is worn on the sleeves of the shirt.
 - i. Garrison jacket – embroidered khaki brown rank slide.
17. Badges of rank are not worn on raincoat or overcoat lightweight.

POSITIONING OF WARRANT OFFICER BADGES OF RANK

18. Badges are worn on both sleeves and are positioned on the upper sleeve of garments, IAW Figure 4H-2 and Figure 4H-3. If the sleeve of a short sleeved shirt is too short to accommodate the badges in the positions specified, WO rank insignia may be placed with the bottom edge in line with the sleeve hem. The badges on both sleeves are to be level.

Figure 4H-2: Service Dress and Utility Jacket for WO2 and WO1 rank



LEFT SLEEVE

Figure 4H-3: Shirts for WO2 and WO1 rank

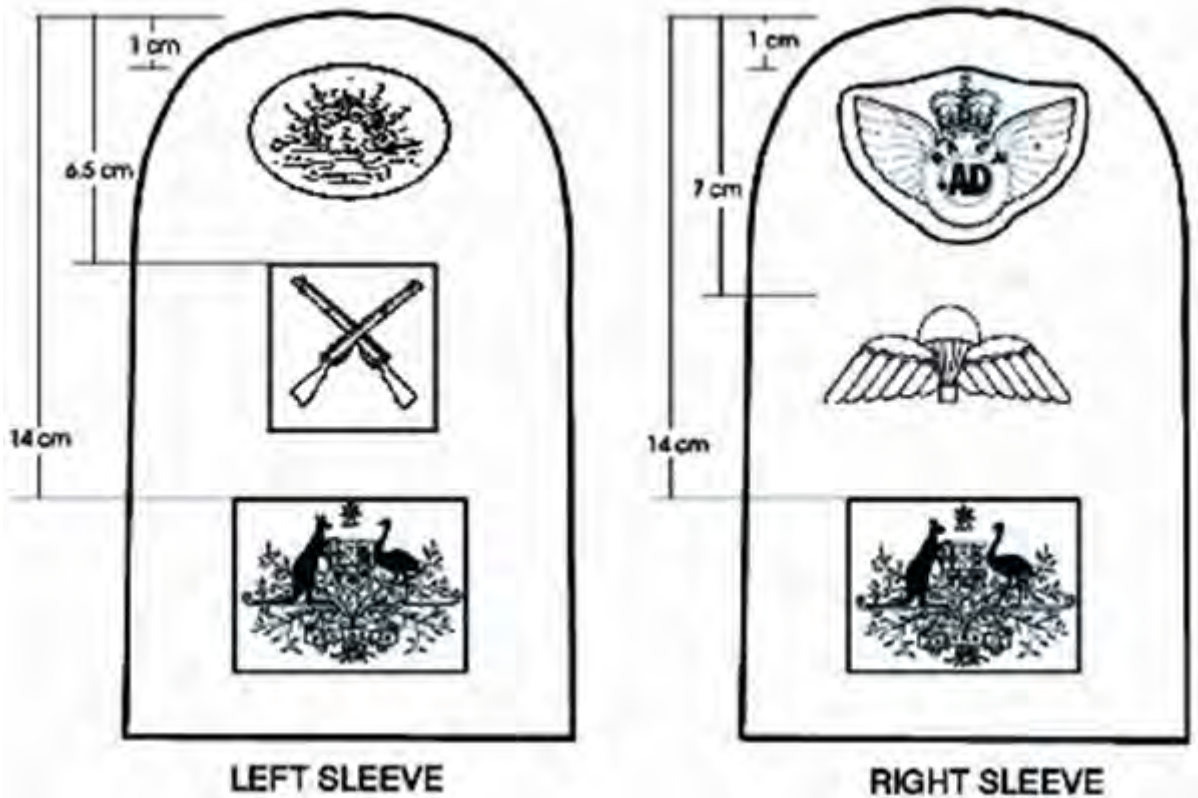

LEFT SLEEVE

RIGHT SLEEVE

NON-COMMISSIONED OFFICER DESCRIPTION

19. NCO badges of rank are in [Appendix 4H1](#). Badges are produced as embroidered or woven badges on appropriate background.
20. 51 FNQR NCOs are to wear black rank insignia on khaki backing with ceremonial and General Duty Dress (polyesters) and Utility jacket; and black rank insignia on white backing with Mess Dress White Jacket.
21. SUR NCOs are to wear black rank insignia on a scarlet backing.
22. Silver coloured embroidered rank insignia is worn by RAAC, AA Avn and RAANC personnel.
23. All other Corps are to wear the gold coloured embroidered rank insignia.

WEARING OF NON-COMMISSIONED OFFICER BADGES OF RANK

24. NCO badges of rank are worn as follows:
 - a. Service Dress – embroidered badge on khaki backing.
 - b. Polyester shirt – embroidered badge on khaki backing.
 - c. Utility jacket – embroidered badge on khaki backing.
 - d. Mess Dress:
 - (1) Mess Dress Army – embroidered silver or gold insignia on black curved shoulder boards.
 - (2) Mess Dress White Jacket – large embroidered badge on white backing.
 - e. Patrol Blue orders of dress – embroidered on blue or white backing.
 - f. Overcoat extreme cold weather – embroidered badge on khaki backing.
 - g. General Duty Dress (AMCU)/Field Dress (AMCU) – black embroidered rank on an AMCU rank slide with black embroidered 'AUSTRALIA' title.
 - h. Working/Protective Dress – AMCU rank is worn on the sleeves of the shirt.
 - i. Garrison jacket – embroidered khaki brown rank slide.
25. Badges of rank are not worn on raincoat or overcoat.

POSITIONING OF NON-COMMISSIONED OFFICER BADGES OF RANK

26. Badges are worn on both sleeves and are positioned on the upper sleeve, IAW Figure 4H-4 and Figure 4H-5. The badges on both sleeves are to be level.

Figure 4H-4: Service Dress and Utility Jacket for PTE (E) to SGT rank

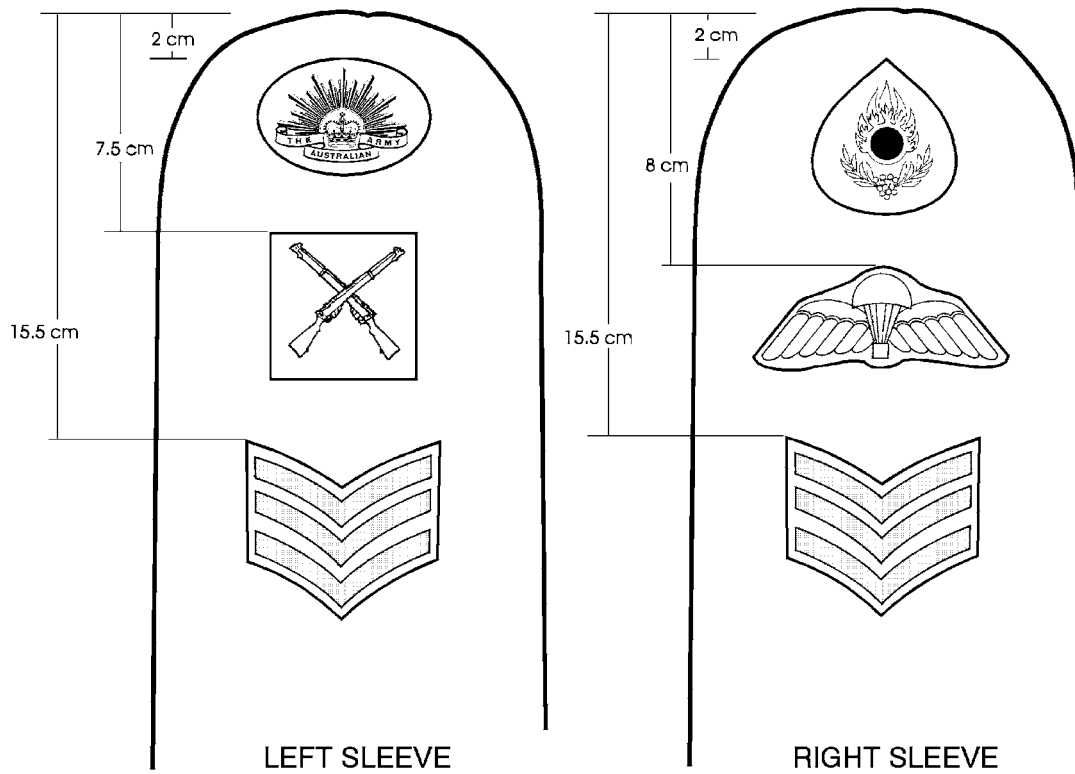
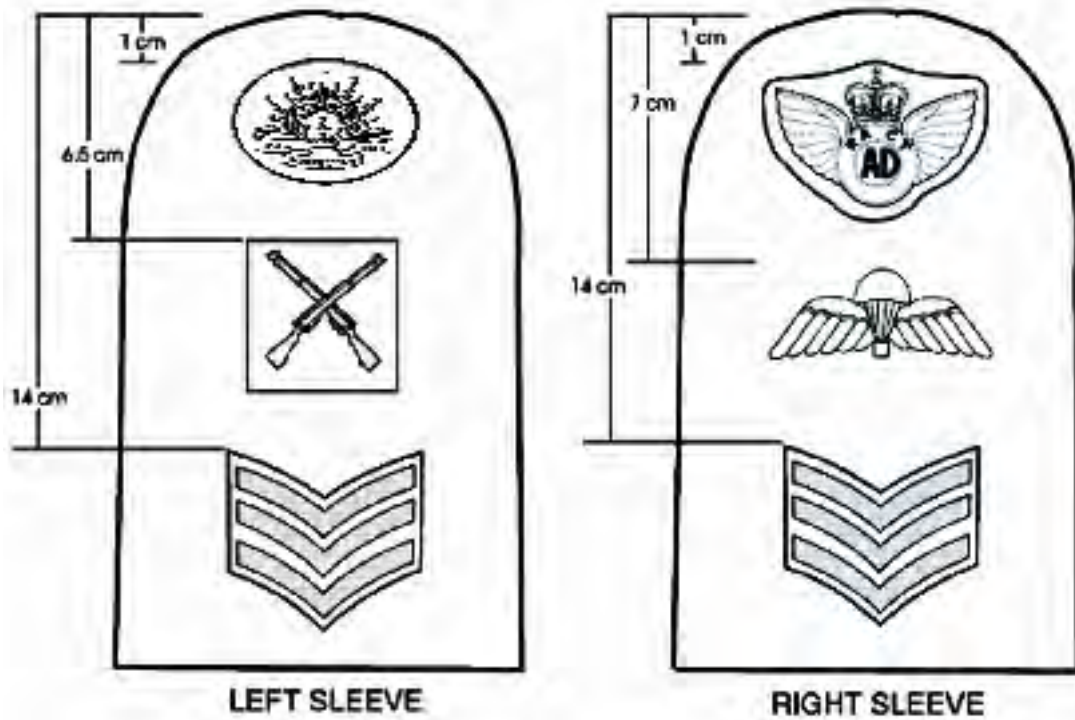

Figure 4H-5: Shirts for PTE (E) to SGT rank





Appendix:





4H1 [Appointment insignia and badges of rank of the Australian Army](#)

APPOINTMENT INSIGNIA AND BADGES OF RANK OF THE AUSTRALIAN ARMY













RANK INSIGNIA – APPOINTED OFFICERS

| GOVERNOR-GENERAL OF AUSTRALIA | STATE GOVERNOR | FIELD MARSHAL |
|--|--|--|
|  |  |  |

RANK INSIGNIA – GENERAL AND SENIOR OFFICERS

| GENERAL (LEFT SHOULDER) | LIEUTENANT GENERAL (LEFT SHOULDER) | MAJOR GENERAL (LEFT SHOULDER) | BRIGADIER | COLONEL |
|---|---|---|--|---|
|  |  |  |  |  |

RANK INSIGNIA – OFFICERS

| | | | | |
|---|---|---|--|---|
| LIEUTENANT COLONEL | MAJOR | CAPTAIN | LIEUTENANT | OFFICER CADET |
|  |  |  |  |  |
| LIEUTENANT COLONEL | MAJOR | CAPTAIN | LIEUTENANT | |
|  |  |  |  | |
| LIEUTENANT COLONEL | MAJOR | CAPTAIN | LIEUTENANT | |
|  |  |  |  | |



RANK INSIGNIA – WARRANT OFFICERS

| WARRANT OFFICER (RSM-A) | WARRANT OFFICER CLASS ONE | WARRANT OFFICER CLASS TWO |
|---|---|---|
|  |  |  |









RANK INSIGNIA – SENIOR NON-COMMISSIONED OFFICERS

| SERGEANT |
|--|
|  |

RANK INSIGNIA – JUNIOR NON-COMMISSIONED OFFICERS







| CORPORAL OR BOMBARDIER | LANCE CORPORAL OR LANCE BOMBARDIER |
|---|--|
|  |  |

RANK INSIGNIA (DPCU) – DPCU AND FIELD AIRANK SLIDES

| GENERAL ^(a) (LEFT SHOULDER) | LIEUTENANT GENERAL ^(a) (LEFT SHOULDER) | MAJOR GENERAL ^(a) (LEFT SHOULDER) |
|---|---|---|
|  |  |  |
| BRIGADIER | COLONEL | LIEUTENANT COLONEL |
|  |  |  |
| MAJOR | CAPTAIN | LIEUTENANT |
|  |  |  |

Note:

- (a) The left shoulder rank slide is the rank slide worn on the front of DPCU shirts and the Coat khaki fleece/Combat jacket interim cold weather.

| | | |
|---|--|--|
| WARRANT OFFICER RSM-A | WARRANT OFFICER CLASS ONE | WARRANT OFFICER CLASS TWO |
|  |  |  |
| SERGEANT | CORPORAL OR BOMBARDIER | LANCE CORPORAL OR LANCE BOMBARDIER |
|  |  |  |
| PRIVATE (E) | | |
|  | | |

**RANK INSIGNIA – MESS DRESS ARMY AND SENIOR RANKS
MESS DRESS**

May be worn by AABC members in concert, when ordered.

| | | | | |
|---|---|---|--|---|
| <p>GENERAL (LEFT SHOULDER)</p> | <p>LIEUTENANT GENERAL (LEFT SHOULDER)</p> | <p>MAJOR GENERAL (LEFT SHOULDER)</p> | <p>BRIGADIER</p> | <p>COLONEL</p> |
|  |  |  |  |  |
| <p>LIEUTENANT COLONEL (GOLD)</p> | <p>LIEUTENANT COLONEL (CHROME)</p> | <p>MAJOR (GOLD)</p> | <p>MAJOR (CHROME)</p> | <p>CAPTAIN (GOLD)</p> |
|  |  |  |  |  |
| <p>CAPTAIN (CHROME)</p> | <p>LIEUTENANT (GOLD)</p> | <p>LIEUTENANT (CHROME)</p> | | |
|  |  |  | | |

RANK INSIGNIA – MESS DRESS ARMY AND SENIOR RANKS MESS DRESS – WARRANT OFFICERS, SENIOR NON-COMMISSIONED OFFICERS AND OTHER RANKS

May be worn by AABC members in concert, when ordered.

| | | |
|---|---|--|
| WARRANT OFFICER (RSM-A) (GOLD) | WARRANT OFFICER CLASS ONE (GOLD) | WARRANT OFFICER CLASS TWO (GOLD) |
|  |  |  |
| SERGEANT (GOLD) | SERGEANT (CHROME) | CORPROAL (GOLD) |
|  |  |  |
| LANCE CORPORAL (GOLD) | PRIVATE/MUSICIAN (GOLD) | |
|  |  | |

RECRUIT INSTRUCTOR BADGE

DESCRIPTION

1. The Recruit Instructor Badge (RIB) is a bronze badge consisting of the letters 'RI' surrounded by a wreath over a scroll bearing the title 'ARMY', as shown in Figure 4I-1. It is dull in colour and is not to be polished.

Figure 4I-1: Recruit Instructor Badge



WEARING THE BADGE

2. The RIB is worn with ceremonial and general duty orders of dress. With General Duty Dress (AMCU) the RIB is worn on only the training establishment identification arm patch, on the right sleeve of the AMCU shirt. The badge is worn on AMCU uniforms in the same manner as the Military Instructor Badge (MIB).
3. The RIB is not to be worn in conjunction with the MIB. The RIB is not worn with Mess Dress, Garrison jacket, raincoat, overcoat lightweight or any order of Protective Dress.

AUSTRALIAN BADGE

4. Only an Australian Army RIB is to be worn on Army uniforms.

POSITIONING THE BADGE

5. When worn with authorised dress, the RIB is worn on the lower left corner of the flap of the right breast pocket, midway between the button and edge of the pocket, with the base of the badge positioned 3 mm above the bottom edge of the pocket, as shown in Figure 4I-2. When worn on the training establishment identification arm patch, it is positioned centrally on the patch.

Figure 4I-2: Positioning the Recruit Instructor Badge

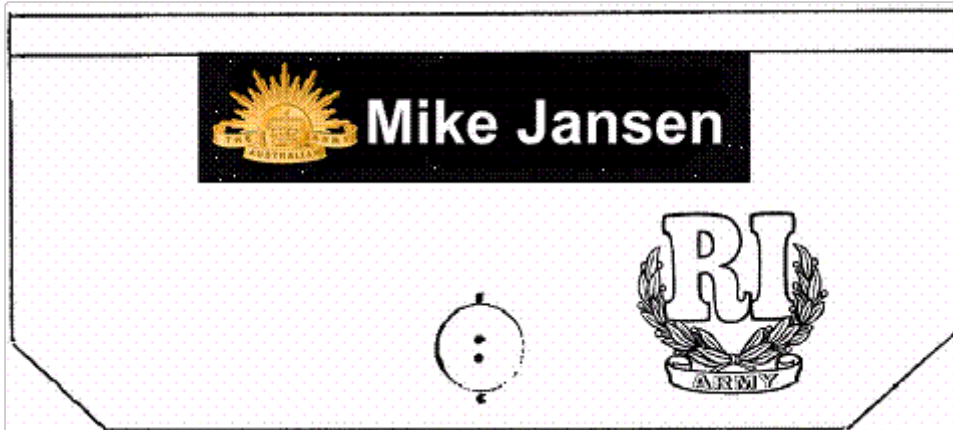

RETIRED MEMBER INSIGNIA

DESCRIPTION

1. The Retired Member Insignia is in the shape of the letter 'R', as shown in Figure 4J-1.

Figure 4J-1: Retired Member Insignia (gold and silver/chrome)



RETIRED MEMBERS

2. An officer may apply in writing to the Chief of Army (CA) through Director-General Career Management–Army (DGCM–A), for approval to use their military title on separation; however, approval is not automatic. If approval is granted, an officer is entitled to use the post-nominal 'Retd' when using their military title. An officer granted a military title may, on occasions authorised by CA or their delegate, wear their uniform with the gold or silver/chrome 'R' insignia. Officers who have been granted a military title on separation may wear their uniform at military ceremonies or military entertainments. The worn uniform is to be appropriate to the rank, Corps and/or unit in which the member last served in the Army. Enquiries to wear uniform on other than military occasions is to be sought from Director-General Army People

Capability (DGAPC). The granted permission to wear a uniform with the 'R' insignia is to be endorsed on the members' separation order.

3. Under [Defence Regulation 2016](#)¹⁸, ORs are not authorised to use their military title after separation and cannot be approved to use the post-nominal 'Retd' title. An OR may apply in writing to the CA through DGCM-A, for approval to wear their military uniform after separation; however, approval is not automatic. If approval is granted, an OR may on occasions authorised by CA or their delegate, wear their uniform without the 'R' insignia at military ceremonies or military entertainments. The worn uniform is to be appropriate to the rank, Corps and/or unit in which the member last served in the Army. Enquiries to wear uniform on other than military occasions is to be sought from DGAPC. The granted permission to wear a uniform is to be endorsed on the members' separation order.

4. Honorary Colonel (COL), Colonel Commandants and Regimental COLs are to wear the gold 'R' insignia, in accordance with [Army Standing Instruction \(Personnel\) Part 12 Chapter 6—Honorary Appointments](#)¹⁹.

WEARING THE BADGE

5. The gold 'R' insignia is worn by authorised officers of all Corps on both shoulders of uniforms. It is worn only with Service Dress, Patrol Blue White Jacket and mess dress orders of dress. Metal 'AUSTRALIA'/Corps/Regiment shoulder titles are not worn with the Retired Member Insignia. The wearing of the gold 'R' insignia is restricted to military activities and ceremonies only.

AUSTRALIAN BADGE

6. Only an Australian Army Retired Member Insignia is to be worn on Army uniforms.

POSITIONING THE BADGE

7. The gold 'R' insignia is worn on the outer end of the epaulette, shoulder board or shoulder cord with the lower edge of the insignia 5 mm from the outer edge of the epaulette, board or cord and 5 mm below badges of rank, as shown in Figure 4J-2. The insignia is not to be worn on embroidered rank slides or with AMCU.

¹⁸ <https://www.legislation.gov.au/Details/F2016L01568>

¹⁹ <https://objective/id:R26414402>

Figure 4J-2: Positioning the Retired Member Insignia

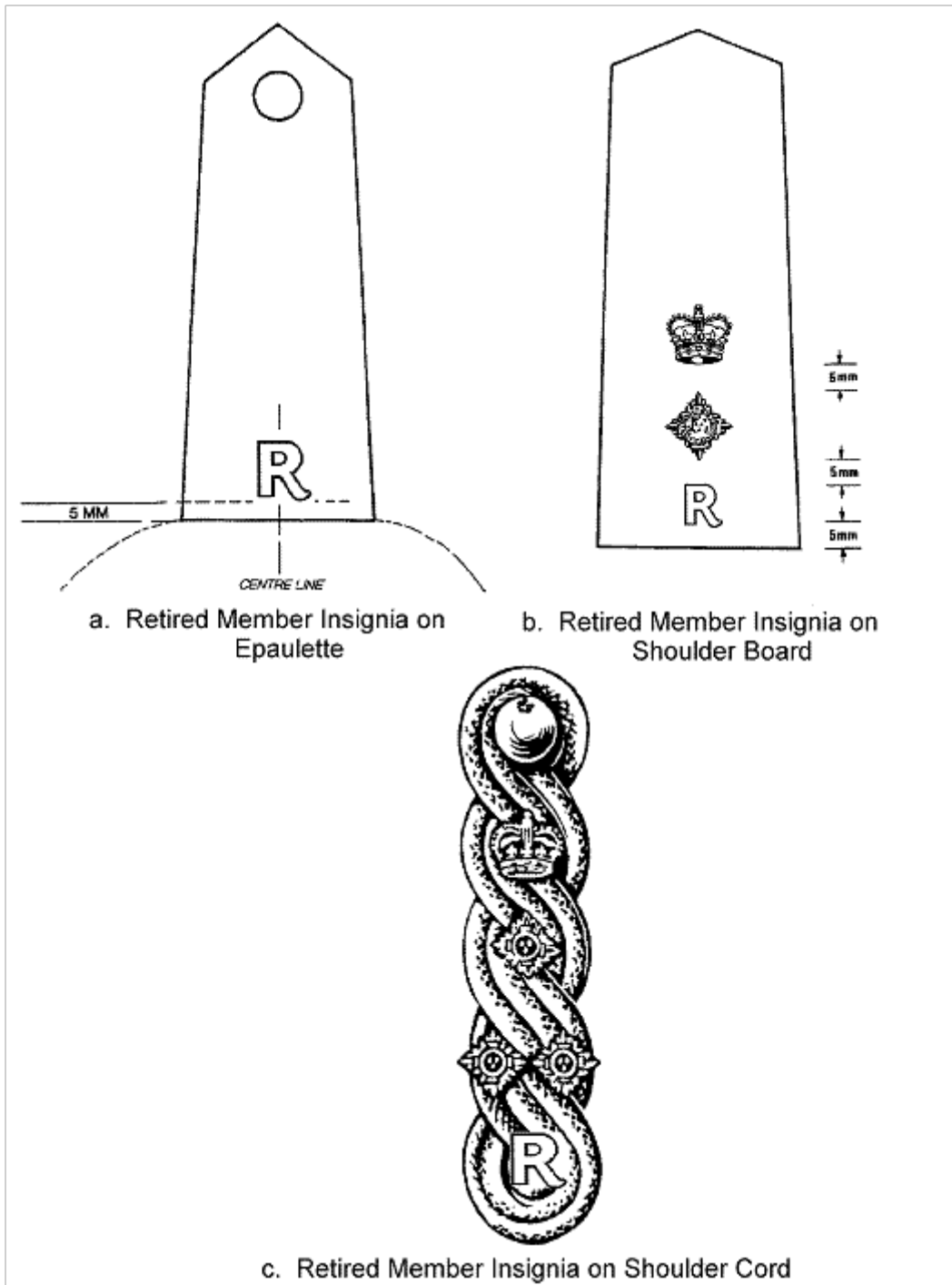

ROYAL CYPHER AND CROWN INSIGNIA

DESCRIPTION

1. The Royal Cypher and Crown insignia depicts the Cypher of Her Majesty, Queen Elizabeth the Second, surmounted by a crown. The insignia is produced in two sizes; small as shown in Figure 4K-1 and large as shown in Figure 4K-2.

Figure 4K-1: Royal Cypher and Crown Insignia (small)



Figure 4K-2: Royal Cypher and Crown Insignia (large)



WEARING THE BADGE

2. The gold insignia is worn only with metal rank badges and only with Service Dress, Patrol Blue White Jacket and mess dress orders of dress.
3. The insignia is worn on the outer end of the epaulette or shoulder board with the lower edge of the insignia 5 mm from the outer edge of the epaulette or board

and 5 mm below badges of rank, as shown in Figure 4K-3. The insignia is not to be worn on embroidered rank slides or with Australian Multi-cam Camouflage Uniform.

Figure 4K-3: Positioning the Royal Cypher and Crown Insignia

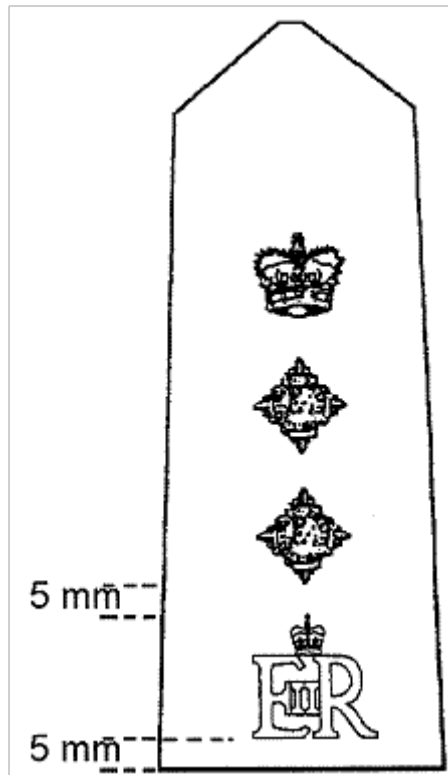

4. On shoulder cords, the insignia is positioned, in accordance with Figure 4K-4.

Figure 4K-4: Positioning the Royal Cypher and Crown Insignia on shoulder cords



DEFENCE COMMENDATIONS

GENERAL

1. The Defence Commendation Scheme is administered under the [Defence Honours and Award Manual Chapter 39](#)²⁰ and is available to all ADF and APS personnel of Defence. Commendations can be awarded to individuals or groups, units or teams. The precedence of Defence Commendations on Army uniform is in descending order in Figure 4L-1 to Figure 4L-18.

SECRETARY AND CHIEF OF THE DEFENCE FORCE COMMENDATIONS

Figure 4L-1: Secretary and Chief of the Defence Force Commendation



Figure 4L-2: Chief of the Defence Force Commendation



Figure 4L-3: Secretary Commendation



²⁰ <http://intranet.defence.gov.au/home/documents/departmental/manuals/dhamv1.htm>

AUSTRALIAN DEFENCE FORCE/SERVICE/DEFENCE SUPPORT SERVICES (LEVEL 3 – GOLD LEVEL)

Figure 4L-4: Australian Defence Force (Level 3 – Gold Level) Commendation



Figure 4L-5: Australian Army (Level 3 – Gold Level) Commendation



Figure 4L-6: Royal Australian Navy (Level 3 – Gold Level) Commendation



Figure 4L-7: Royal Australian Air Force (Level 3 – Gold Level) Commendation



Figure 4L-8: Defence Support Services (Level 3 – Gold Level) Commendation



AUSTRALIAN DEFENCE FORCE/SERVICE/DEFENCE SUPPORT SERVICES (LEVEL 2 – SILVER LEVEL)

Figure 4L-9: Australian Defence Force (Level 2 – Silver Level) Commendation



Figure 4L-10: Australian Army (Level 2 – Silver Level) Commendation



Figure 4L-11: Royal Australian Navy (Level 2 – Silver Level) Commendation



4L-4

Figure 4L-12: Royal Australian Air Force (Level 2 – Silver Level) Commendation



Individual

Figure 4L-13: Defence Support Services (Level 2 – Silver Level) Commendation



Individual

AUSTRALIAN DEFENCE FORCE/SERVICE/DEFENCE SUPPORT SERVICES (LEVEL 1 – BRONZE LEVEL)

Figure 4L-14: Australian Defence Force (Level 1 – Bronze Level) Commendation



Individual

Figure 4L-15: Australian Army (Level 1 – Bronze Level) Commendation



Individual

Figure 4L-16: Royal Australian Navy (Level 1 – Bronze Level) Commendation



Individual

Figure 4L-17: Royal Australian Air Force (Level 1 – Bronze Level) Commendation



Individual

Figure 4L-18: Defence Support Services (Level 1 – Bronze Level) Commendation



Individual

WEARING THE BADGE

2. Commendation badges are worn on all general duty (polyesters), general duty Service dress and ceremonial orders of dress. Badges are **not** worn on the raincoat, overcoat, General Duty Dress (AMCU), Field Dress (AMCU) or Protective Dress. Miniature commendation badges are worn with mess dress orders of dress, in accordance with [Annex 5O](#), and may be worn on civilian coats and jackets. No more than four commendations are to be worn; this includes a Soldier's Medallion, if awarded. Personnel may choose to wear only one Commendation, the option is either

- a. the first commendation awarded
- b. the most senior commendation awarded.

POSITIONING THE BADGE

3. The badge is worn centrally over the right breast pocket. The bottom of the badge is positioned 1 cm above the top of the Army Individual Readiness Notification

(AIRN) Badge or Citation(s). The bottom of the badge is positioned 3 mm above the upper edge of the pocket flap, if no AIRN Badge is worn. Other variation to the wearing of commendation badges is in Figure 4L-19 and Figure 4L-20.

Figure 4L-19: Wearing Defence Commendation Badges

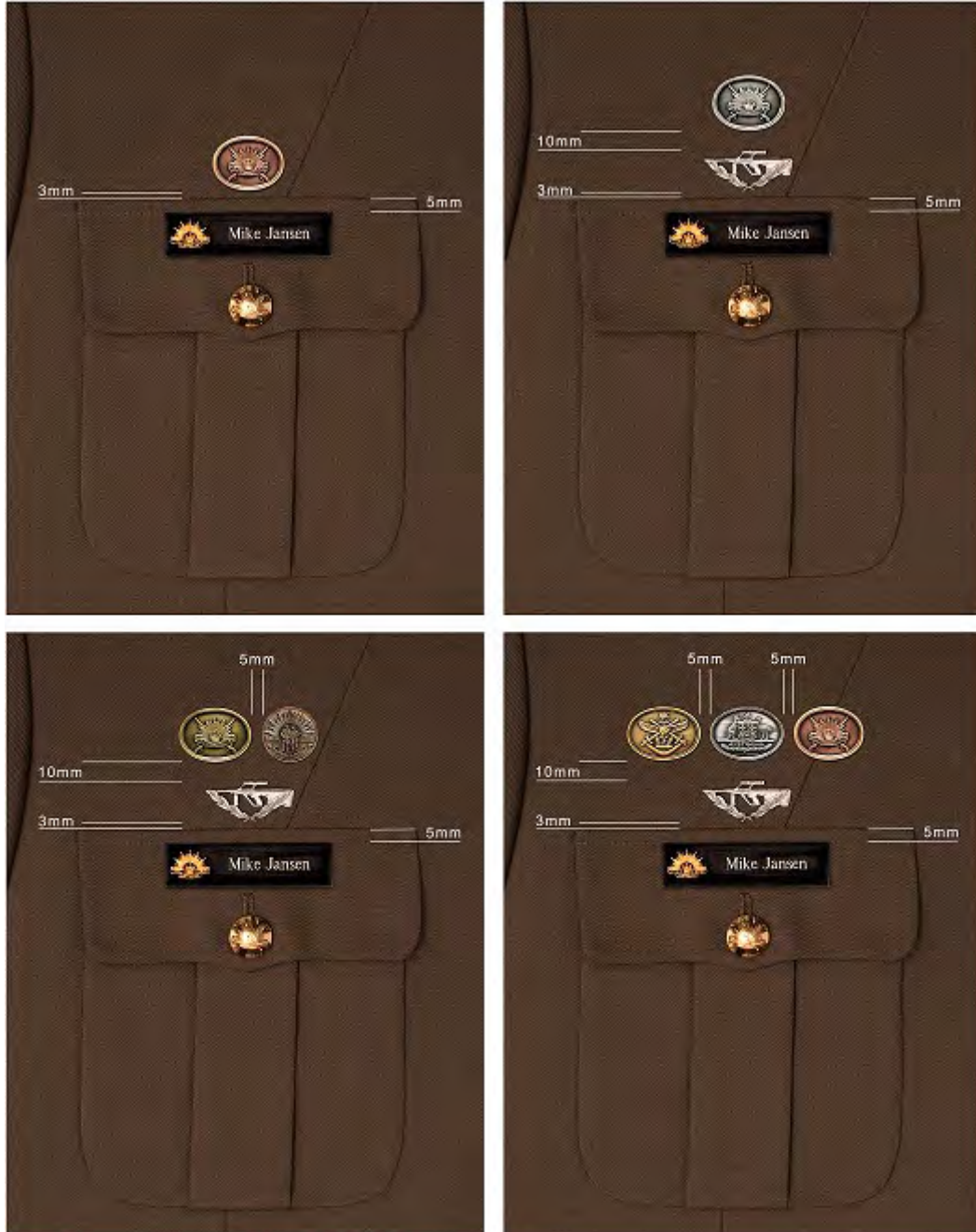

Figure 4L-20: Wearing Defence Commendation Badges



SKILL AT ARMS BADGE

GENERAL

1. The following Skill at Arms Badges are as follows:
 - a. Skill at Arms
 - b. Sniper
 - c. Army Top 20.

SKILL AT ARMS BADGE DESCRIPTION

2. The Skill at Arms Badge is in the form of a pair of crossed Lee Enfield .303 rifles, in accordance with (IAW) Figure 4M-1.

Figure 4M-1: Skill at Arms Badge



ELIGIBILITY FOR THE SKILL AT ARMS BADGE

3. The Skill at Arms Badge is awarded to members who achieve the appropriate marksman score during the conduct of the Applied Marksmanship Practice, IAW

[Land Warfare Procedures—General 7-4-12—5.56mm Austeyr Family of Weapons—Volume Three](#)²¹.

4. Personnel who qualify for the award of the Skill at Arms Badge are entitled to wear the badge from the date of the qualification for a period of two years. For the Skill at Arms Badge to be worn in perpetuity the individual must:
 - a. meet initial qualification requirements
 - b. re-qualify not less than one year from initial qualification date and not more than two years from initial qualification date.

WEARING THE SKILL AT ARMS BADGE

5. Embroidered badges on appropriate background are worn on Service Dress, polyester shirts, Safari Suit jacket and the Utility jacket. Only one badge is to be worn.
6. Officers, Warrant Officers and Senior Non-Commissioned Officers wear the full size Skill at Arms Badge on white backing, with Mess Dress White Jacket, and black backing with all Army Mess Dress jackets, and positioned in the same manner as for the Service Dress jacket. The wearing of the Skill at Arms Badge by officers with mess dress orders of dress is optional. If worn, officers are to wear miniature bullion badges on blue backing, purchased at the members' expense. These badges are positioned, IAW [Annex 5O](#).
7. The badge is not worn on overcoats, raincoats, General Duty Dress (AMCU), field or protective orders of dress or the Garrison jacket.

POSITIONING THE SKILL AT ARMS BADGE

8. With all garments on which the badge is worn, it is positioned centrally on the upper left sleeve, IAW Figure 4M-2.

²¹ http://10.16.16.23/Doctrine/Doctrine_Online_Source_Files/LWP-G_7-4-12_5.56_mm_Austeyr_Family_of_Weapons_Volume_Three_Full.pdf

Figure 4M-2: Positioning the Skill at Arms and Sniper Badge

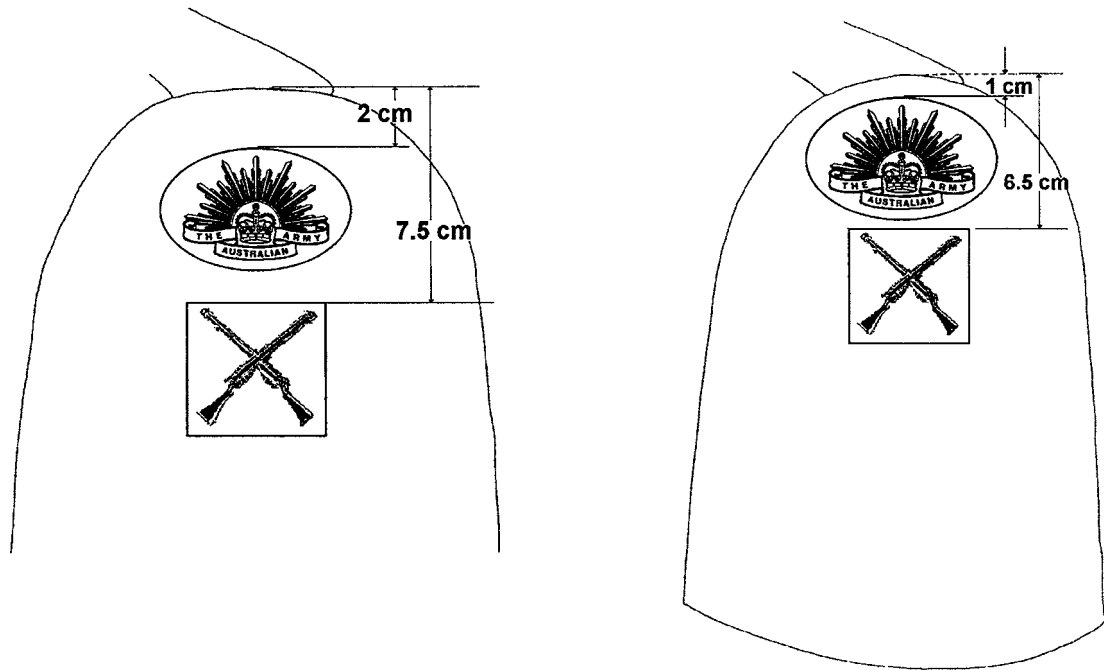

a. Service Dress Jacket

b. Shirt/Safari Suit Jacket

SNIPER BADGE DESCRIPTION

9. A person qualified as a sniper is eligible to wear the Skill at Arms Badge with the letter 'S' positioned centrally between the barrels of the pair of crossed Lee Enfield .303 rifles, IAW Figure 4M-3.

Figure 4M-3: Sniper Badge



WEARING THE SNIPER BADGE

10. The Sniper Badge is worn in the same manner as the Skill at Arms Badge, IAW Figure 4M-2. Only one badge is to be worn.

POSITIONING THE SNIPER BADGE

11. The Sniper Badge is positioned in the same manner as the Skill at Arms Badge, IAW Figure 4M-2.

ARMY TOP 20 BADGE DESCRIPTION

12. The Army Top 20 Badge depicts a pair of crossed Lee Enfield .303 rifles surrounded by a wreath, IAW Figure 4M-4.

Figure 4M-4: Army Top 20 Badge



ARMY TOP 20 BADGE ELIGIBILITY

13. The Army Top 20 Badge may be worn by those members who qualify as the final 20 competitors at the Champion Shot for the Army competition held annually. The badge is sponsored by the Director of Infantry.

WEARING THE ARMY TOP 20 BADGE

14. The Army Top 20 Badge is worn in place of the Skill at Arms Badge and in the same manner as that badge. A member qualified as a sniper who is also qualified for an Army Top 20 Badge may choose to wear either the Sniper Badge or the Army Top 20 Badge, but not both.

OFFICIAL

ADM

4M-5

15. The Army Top 20 Badge is worn in perpetuity.

POSITIONING THE ARMY TOP 20 BADGE

16. The Army Top 20 Badge is positioned in the same manner as the Skill at Arms Badge, IAW Figure 4M-2.

AUSTRALIAN BADGE

17. Only an Australian Army Skill at Arms, Sniper or Army Top 20 badge is to be worn on Army uniforms.

AL5

OFFICIAL

SOLDIERS MEDALLION BADGE

DESCRIPTION

1. The Soldiers Medallion for Exemplary Service (SMES) Badge is a miniature of the Soldiers Medallion. The badge is bronze and measures approximately 25 mm in diameter. The design is based on the two central figures of the Army Memorial with the wording 'EXEMPLARY SERVICE—AUSTRALIAN ARMY', in accordance with (IAW) Figure 4N–1.

Figure 4N–1: Soldiers Medallion Badge



ELIGIBILITY

2. Soldiers of the rank of Corporal and below who have given exemplary service well above that expected of soldiers in the performance of their duties and have not been recognised by another award, for that service, are eligible for the award of the SMES Badge. The badge is worn in perpetuity by entitled personnel and is also worn with commendation badges.

WEARING THE BADGE

3. Once awarded, the SMES Badge can be worn by all ranks. It is worn displaying the obverse side, in the same manner as a Defence commendation badge, IAW [Annex 4L](#).

4. The SMES Badge is worn with the following orders of dress:
- Ceremonial Parade Dress
 - Ceremonial Dress
 - Safari Suit Jacket
 - General Duty Dress (polyester)

OFFICIAL

ADM

4N-2

- e. General Duty Service Dress.
- 5. A miniature SMES Badge is worn with the mess dress orders of dress.
- 6. The badge is **not** worn on the raincoat, overcoat, General Duty Dress (AMCU), Field Dress (AMCU) or Protective Dress.

AL5

OFFICIAL

TRADE QUALIFICATION BADGE

GENERAL

1. The trade qualification badges which are currently authorised are as follows:
 - a. Air Dispatcher
 - b. Ammunition Technical Officer/Technician (ATO)
 - c. Artificer
 - d. Conductor (RAAOC)
 - e. Drummer
 - f. Explosive Detection Dog
 - g. Explosive Ordnance Disposal (EOD)
 - h. Emergency Response
 - i. Ground Crewman Aircraft Support (GCAS)
 - j. Musician
 - k. Operator Petroleum (OP PET)
 - l. Parachute Rigger
 - m. Piper
 - n. Physical Training Instructor.

DESCRIPTION

2. The description of each individual trade qualification badge is in the respective appendices to this annex.

WEARING THE BADGE

3. Trade qualification badges are worn by qualified personnel with ceremonial, general duty (polyesters), Safari Suit jacket, general duty Service dress, general duty (AMCU) and mess dress orders of dress. Only one trade badge is to be worn at any time on the right sleeve, irrespective of the number to which a member may be entitled. The badge to be worn is that of the trade to which a member is currently posted. If a member is not in a trade appointment, a choice may be made of any one badge to which the member is entitled.
4. Only one patch is to be worn on the right sleeve. Trade patches are not to be sewn on to the sleeve of the AMCU shirt.

5. The wearing of trade badges by officers with all Mess Dress jackets is optional. If worn, officers are to wear miniature bullion or full size metallic badges on blue/black backing, according to the type of jacket, purchased at the members' expense. These badges are positioned, in accordance with (IAW) [Annex 5O](#).

AUSTRALIAN BADGE

6. Only an Australian Army trade qualification badge is to be worn on Army uniforms.

POSITIONING THE BADGE

7. All trade qualification badges are positioned centrally at the top of the right sleeve. On shirts the top centre of the badge backing is positioned 1 cm below the shoulder seam of garments. On jackets the top centre of the badge backing is positioned 2 cm below the shoulder seam, as shown in Figure 4O-1.

8. Warrant Officers and Senior Non-Commissioned Officers are to wear full size trade badges with mess dress orders of dress. The badge is positioned on the jacket in the same manner as the Service Dress jacket. All personnel are to wear the full size badge on the khaki polyester shirt.

9. Trade badges are not worn on the Garrison jacket, raincoats, overcoats or Protective Dress.

10. Coloured ATO, Emergency Response, OP PET and EOD badges may be worn on the right side velcro patch of the AMCU shirt. They are worn with all orders of dress by qualified personnel rostered for duty and/or serving at an EOD control centre. When more than one patch is identified to be worn, ie USP/Operational Shoulder Patch and Trade qualification patch, the Commanding Officer of the unit is to establish unit policy on which patch is to be worn in place of the USP.

Figure 40-1: Positioning the Trade Badges

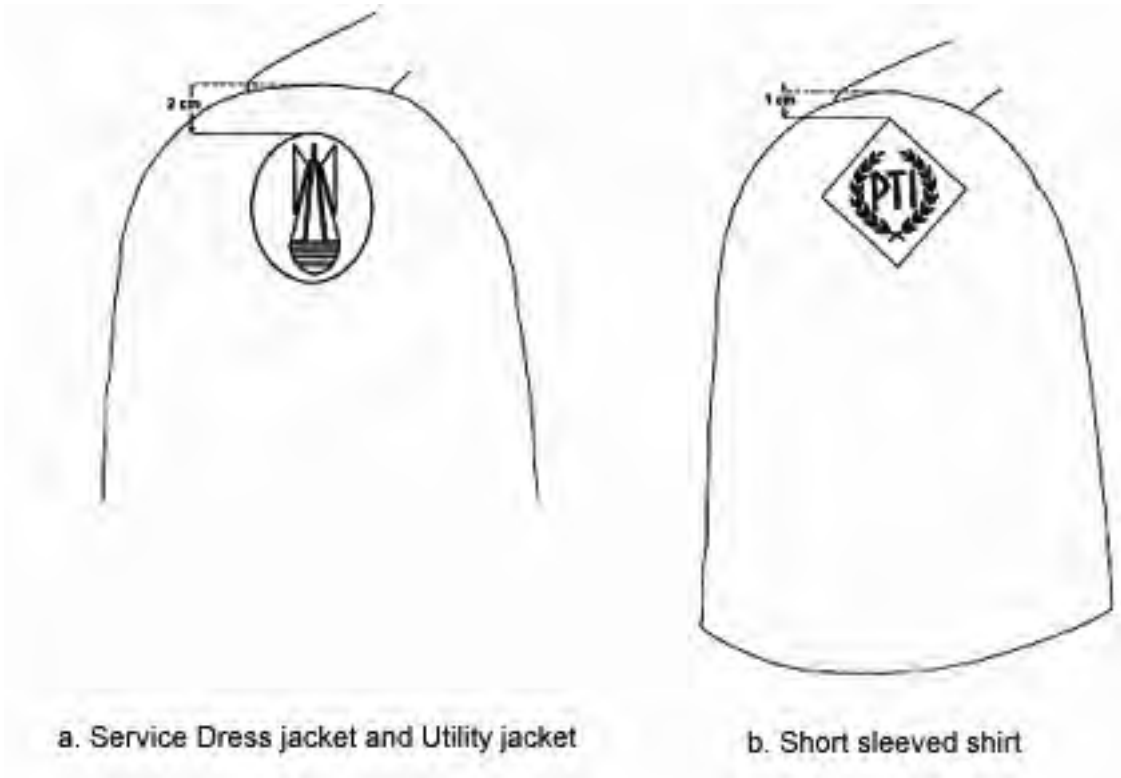

Appendices:

- 401 [Air dispatcher](#)
- 402 [Ammunition Technical Officer/Ammunition Technician](#)
- 403 [Artificer](#)
- 404 [Conductor \(Royal Australian Army Ordnance Corps\) Badge](#)
- 405 [Drummer](#)
- 406 [Explosive Detection Dog](#)
- 407 [Explosive Ordnance Disposal](#)
- 408 [Emergency Response](#)
- 409 Ground Crewman Aircraft Support
- 4010 [Musician](#)
- 4011 [Operator Petroleum](#)
- 4012 [Parachute Rigger](#)
- 4013 [Piper](#)
- 4014 [Physical training instructor](#)

AIR DISPATCHER

DESCRIPTION

1. The Air Dispatcher (AD) Badge depicts elevated and spread wings, with a circlet bearing the letters 'RACT' surrounding the initials 'AD' and surmounted by a crown, as shown in Figure 4O1-1.

Figure 4O1-1: Air Dispatcher Badge



ELIGIBILITY

2. The badge is to be worn by a member who has qualified as an AD RACT and has completed the required number of sorties, in accordance with (IAW) RACT policy.

WEARING THE BADGE

3. The item of dress and the type of badge to be worn with the particular garment is in Table 4O1-1. The badge is not worn on any item that is not listed in Table 4O1-1.

Table 4O1-1: Wearing the Air Dispatcher Badge

| Serial | Dress | Badge | Remarks |
|--------|-----------------------|--|---|
| 1 | Service Dress | Embroidered in colour on a khaki background | |
| 2 | Shirt Khaki Polyester | Embroidered in colour on a khaki background | |
| 3 | Safari Suit Jacket | Embroidered in colour on a khaki background | Officers only |
| 4 | Utility Jacket | Embroidered in colour on a khaki background | |
| 5 | Mess Dress | Embroidered bullion badge in miniature size in gold and silver on blue/black backing for officers only | Badge optional for officers, IAW Annex 4O |

OFFICIAL

ADM

401-2

| Serial | Dress | Badge | Remarks |
|---------------|---|--|----------------|
| 6 | Mess Dress Army, Senior Ranks Mess Dress, and Mess Dress White Jacket | Full size embroidered badge on black/white background | |
| 7 | Patrol Blue orders of dress | Embroidered in colour on blue/white background | |

AL5

OFFICIAL

AMMUNITION TECHNICAL OFFICER/AMMUNITION TECHNICIAN

DESCRIPTION

1. The Ammunition Technical Officer (ATO)/Ammunition Technician (AT) Badge depicts a flaming bomb surmounted on a demi wreath of wattle, as shown in Figure 402–1.

Figure 402–1: Ammunition Technical Officer/Ammunition Technician Badge



ELIGIBILITY

2. The badge is to be worn by a member who has qualified as an ATO/AT, in accordance with (IAW) Royal Australian Army Ordnance Corps policy.

WEARING THE BADGE

3. The item of dress and the type of badge to be worn with the particular garment is in Table 402–1. The badge is not worn on any item that is not listed in Table 402–1.

Table 402-1: Wearing the Ammunition Technical Officer/Ammunition Technician Badge

| Serial | Dress | Badge | Remarks |
|---------------|--|--|---|
| 1 | Service Dress | Embroidered in colour on khaki background | |
| 2 | Shirt Khaki Polyester | Embroidered in colour on khaki background | |
| 3 | Safari Suit Jacket | Embroidered in colour on khaki background | Officers only |
| 4 | Utility Jacket | Embroidered in colour on khaki background | |
| 5 | Mess Dress | Embroidered bullion badge in miniature size in gold and silver on blue/black backing for officers only | Badge optional for officers, IAW Annex 4O |
| 6 | Mess Dress Army, Senior Rank Mess Dress, and Mess Dress White Jacket | Full size embroidered badge on black/white background | |
| 7 | Patrol Blue orders of dress | Embroidered in colour on blue/white background | |
| 8 | Australian Multi-cam Camouflage Uniform | Embroidered in colour on AMCU background | On a velcro patch or AMCU brassard |

ARTICIFER

DESCRIPTION

1. The Artificer Badge depicts crossed hammer and pincers, as shown in Figure 403–1.

Figure 403–1: Artificer Badge



ELIGIBILITY

2. The badge is to be worn by a member who has qualified as an artificer, in accordance with (IAW) Royal Australian Electrical and Mechanical Engineers policy.

WEARING THE BADGE

3. The item of dress and the type of badge to be worn with the particular garment is in Table 403–1. The badge is not worn on any item that is not listed in Table 403–1.

Table 403–1: Wearing the Artificer Badge

| Serial | Dress | Badge | Remarks |
|---------------|-----------------------|---|---|
| 1 | Service Dress | Embroidered in gold on a khaki background | |
| 2 | Shirt Khaki Polyester | Embroidered in gold on a khaki background | |
| 3 | Safari Suit Jacket | Embroidered in gold on a khaki background | Officers only |
| 4 | Utility Jacket | Embroidered in gold on a khaki background | |
| 5 | Mess Dress | Embroidered bullion badge in miniature size in gold on blue/black backing for officers only | Badge optional for officers, IAW Annex 4O |

OFFICIAL

ADM

403-2

| Serial | Dress | Badge | Remarks |
|---------------|---|---|----------------|
| 6 | Mess Dress, Senior Ranks Mess Dress and Mess Dress White Jacket | Full size embroidered badge on black/white background | |
| 7 | Patrol Blue orders of dress | Embroidered in gold on blue/white background | |

AL5

OFFICIAL

CONDUCTOR (ROYAL AUSTRALIAN ARMY ORDNANCE CORPS) BADGE

DESCRIPTION

1. The Conductor (RAAOC) is the approved recognition of trade mastery within selected employment categories among RAAOC WO1s. The Conductor (RAAOC) badge depicts the Federation Star above the RAAOC Shield atop a boomerang, in accordance with (IAW) Figure 4O4–1.

Figure 4O4–1: Conductor (Royal Australian Army Ordnance Corps) Badge



ELIGIBILITY

2. The badge is to be worn by RAAOC WO1s or if necessary a selected RAAOC WO2s who have been appointed as a Conductor by Head of Corps RAAOC. Each of the following RAAOC trades are entitled to have one Conductor:

- a. Employment Category Number (ECN) 150 – Command Support Clerk
- b. ECN 269 – Operator Petroleum
- c. ECN 296 – Operator Unit Supply
- d. ECN 298 – Operator Supply Chain
- e. ECN 296/298 – Operator Supply (Aviation Specialist)
- f. ECN 345 – Rigger Parachute

- g. ECN 401 – Technician Ammunition.

WEARING THE BADGE

3. The badge is to be worn at the top of the sleeve of the shirt right sleeve, IAW other trade badges. The Conductors badge takes precedence over all other trade qualification badges and is to be worn in preference to any other trade qualification badge. A Conductor is entitled to retain this Badge on their uniforms after their tenure expires as per RAAOC Regimental Instruction Number 26.

4. The item of dress and the type of badge to be worn with the particular garment is in Table 404–1. The badge is not worn on any item that is not listed in Table 404–1.

Table 404–1: Wearing the Conductor Royal Australian Army Ordnance Corps Badge

| Serial | Dress | Badge | Remarks |
|---------------|--|---|----------------|
| 1 | Service Dress | Embroidered in colour on a khaki background | |
| 2 | Shirt Khaki Polyester | Embroidered in colour on a khaki background | |
| 3 | Safari Suit Jacket | Embroidered in colour on a khaki background | Officers only |
| 4 | Utility Jacket | Embroidered in colour on a khaki background | |
| 5 | Mess Dress | Embroidered in colour on blue/black background | |
| 6 | Mess Dress Army, Senior Ranks Mess Dress and Mess Dress White Jacket | Full size embroidered badge on black/white background | |
| 7 | Patrol Blue orders of dress | Embroidered in colour on blue/white background | |

DRUMMER

DESCRIPTION

1. The Drummer Badge depicts a rope tensioned drum, as shown in Figure 405–1.

Figure 405–1: Drummer Badge



ELIGIBILITY

2. The badge is to be worn by a member who has qualified as a Corps drummer, IAW AABC policy.

WEARING THE BADGE

3. The item of dress and the type of badge to be worn with the particular garment is in Table 405–1. The badge is not worn on any item that is not listed in Table 405–1.

Table 405–1: Wearing the Drummer Badge

| Serial | Dress | Badge | Remarks |
|--------|-----------------------|---|---------------|
| 1 | Service Dress | Embroidered in colour on khaki background | |
| 2 | Shirt Khaki Polyester | Embroidered in colour on khaki background | |
| 3 | Safari Suit Jacket | Embroidered in colour on khaki background | Officers only |
| 4 | Utility Jacket | Embroidered in colour on khaki background | |

OFFICIAL

ADM

405-2

| Serial | Dress | Badge | Remarks |
|---------------|--|--|---|
| 5 | Mess Dress | Embroidered bullion badge in miniature size in gold and silver on blue/black backing for officers only | Badge optional for officers, IAW Annex 40 |
| 6 | Mess Dress Army, Senior Ranks Mess Dress and Mess Dress White Jacket | Full size embroidered badge on black/white background | |
| 7 | Patrol Blue orders of dress | Embroidered in colour on blue/white background | |
| 8 | Band Ceremonial Dress | Embroidered on scarlet/blue/white or green background | |

AL5

OFFICIAL

EXPLOSIVE DETECTION DOG

DESCRIPTION

1. The Explosive Detection Dog (EDD) Badge depicts a right profile of the German Shepherd breed of dog with the letters 'RAE' below, on Australian Multi-cam Camouflage Uniform (AMCU) background, as shown in Figure 406–1.

Figure 406–1: Explosive Detection Dog Badge



ELIGIBILITY

2. The badge is to be worn by a member of the RAE who has qualified in EDD handling, in accordance with RAE policy and is currently posted to an authorised established position as an EDD Handler or Trainer, when directed by commanders or Commanding Officers (CO) whilst in barracks or on operations, both within and outside of Australia.

WEARING THE BADGE

3. The item of dress and the type of badge to be worn with the particular garment is in Table 406–1. The badge is not worn on any item that is not listed in Table 406–1.
4. The badge is to be worn on the velcro patch on the right sleeve of the AMCU shirt or on a AMCU brassard on the right sleeve of the Protective Dress shirt. The EDD Badge may be worn in place of the USP, but only at the discretion of the commander or CO.

Table 406–1: Wearing the Explosive Detection Dog Badge

| Serial | Dress | Badge | Remarks |
|--------|---------------------------|---|------------------------------------|
| 1 | AMCU and Protective Dress | Embroidered in black on AMCU background, 75mm x 55 mm | On a velcro patch or AMCU brassard |

EXPLOSIVE ORDNANCE DISPOSAL

DESCRIPTION

1. The Explosive Ordnance Disposal (EOD) Badge depicts a bomb on a scarlet oval background, as shown in Figure 407-1.

Figure 407-1: Explosive Ordnance Disposal Badge



ELIGIBILITY

2. The badge is to be worn by a member of the RAE who has qualified as an EOD, in accordance with (IAW) RAE policy.

WEARING THE BADGE

3. The item of dress and the type of badge to be worn with the particular garment is in Table 407-1. The badge is not worn on any item that is not listed in Table 407-1.

Table 407-1: Wearing the Explosive Ordnance Disposal Badge

| Serial | Dress | Badge | Remarks |
|--------|---------------|---|---------|
| 1 | Service Dress | Embroidered in colour on scarlet background | |

OFFICIAL

ADM

407-2

| Serial | Dress | Badge | Remarks |
|---------------|---|--|---|
| 2 | Shirt Khaki Polyester | Embroidered in colour on scarlet background | |
| 3 | Safari Suit Jacket | Embroidered in colour on scarlet background | Officers only |
| 4 | Utility Jacket | Embroidered in colour on scarlet background | |
| 5 | Mess Dress Senior Ranks Mess Dress | Embroidered bullion badge in miniature size in gold and silver on blue/black backing for officers only | Badge optional for officers, IAW Annex 4O |
| 6 | Mess Dress Army Mess Dress White Jacket | Embroidered in colour on scarlet background | |
| 7 | Patrol Blue orders of dress | Embroidered in colour on scarlet background | |
| 8 | Australian Multi-cam Camouflage Uniform (AMCU) and Protective Dress | Embroidered in scarlet colour on AMCU background | On a velcro patch or AMCU brassard |

AL5

OFFICIAL

EMERGENCY RESPONSE

DESCRIPTION

1. The Emergency Response (ER) Badge depicts the RAE flaming grenade, surmounted on a coiled rope. The inner badge is surrounded by a laurel wreath resting upon a scroll, depicting the words 'EMERGENCY RESPONSE', as shown in Figure 408–1. The ER badge can also be worn as a shoulder patch or on a brassard with Australian Multi-cam Camouflage as the background.

Figure 408–1: Emergency Response Badge



ELIGIBILITY

2. The badge is worn by a member who has qualified as an Operator Emergency Responder.

WEARING THE BADGE

3. The item of dress and the type of badge to be worn with the particular garment is in Table 408–1. The badge is not worn on any item that is not listed in Table 408–1.

Table 408–1: Wearing the Emergency Response Badge

| Serial | Dress | Badge | Remarks |
|--------|-----------------------|---|---------|
| 1 | Service Dress | Embroidered in colour on khaki background | |
| 2 | Shirt Khaki Polyester | Embroidered in colour on khaki background | |

OFFICIAL

ADM

408-2

| Serial | Dress | Badge | Remarks |
|---------------|--|---|------------------------------------|
| 3 | Safari Suit Jacket | Embroidered in colour on khaki background | Officers only |
| 4 | Utility Jacket | Embroidered in colour on khaki background | |
| 5 | Mess Dress | Embroidered in colour on blue/black background | |
| 6 | Mess Dress Army, Senior Ranks Mess Dress and Mess Dress White Jacket | Embroidered in colour on black/white background | |
| 7 | Patrol Blue orders of dress | Embroidered in colour on blue/white background | |
| 8 | Australian Multi-cam Camouflage Uniform | Embroidered in colour on AMCU background | On a velcro patch or AMCU brassard |

AL5

OFFICIAL

GROUND CREWMAN AIRCRAFT SUPPORT

DESCRIPTION

4. The ground Crewman Aircraft Support (GCAS) trade qualifies soldiers as operators Forward Arming and Refuelling Points (FARP). The GCAS Badge depicts a stylistic helicopter above a boomerang embroidered with the letters 'GCAS' as shown in Figure 4O9-1. The tri backing of the badge represents the international hazards goods placard.

Figure 4O9–1: Ground Crewman Aircraft Support (GCAS) Badge



ELIGIBILITY

5. The badge may be worn by a member who has qualified as an ECN 164, Ground Crewman Aircraft Support.

WEARING THE BADGE

6. The item of dress and the type of badge to be worn with the particular garments is in Table 4O9-1. The badge is not worn on any item that is not listed in Table 4O9-1.

Table 409-1: Wearing the Ground Crewman Aircraft Support Badge

| Serial | Dress | Badge | Remarks |
|---------------|--|---|----------------|
| 1 | Service Dress | Embroidered in colour on khaki background | |
| 2 | Shirt Khaki Polyester | Embroidered in colour on khaki background | |
| 3 | Safari Suit Jacket | Embroidered in colour on khaki background | Officers only |
| 4 | Utility Jacket | Embroidered in colour on khaki background | |
| 5 | Mess Dress | Embroidered in colour on blue/black background | |
| 6 | Mess Dress Army, Senior Ranks Mess Dress and Mess Dress White Jacket | Embroidered in colour on black/white background | |
| 7 | Patrol Blue orders of dress | Embroidered in colour on blue/white background | |

MUSICIAN

DESCRIPTION

1. The Musician Badge depicts a Lyre on oak leaves surmounted by a crown, as shown in Figure 4O10–1.

Figure 4O10–1: Musician Badge



ELIGIBILITY

2. The badge is to be worn by a member who has qualified as a Musician Employment Category Number 240–2, in accordance with (IAW) AABC policy.

WEARING THE BADGE

3. The item of dress and the type of badge to be worn with the particular garment is in Table 4O10–1. The badge is not worn on any item that is not listed in Table 4O10–1.

Table 4O10–1: Wearing the Musician Badge

| Serial | Dress | Badge | Remarks |
|---------------|-----------------------|---|----------------|
| 1 | Service Dress | Embroidered in colour on khaki background | |
| 2 | Shirt Khaki Polyester | Embroidered in colour on khaki background | |
| 3 | Safari Suit Jacket | Embroidered in colour on khaki background | Officers only |

OFFICIAL

ADM

4O10-2

| Serial | Dress | Badge | Remarks |
|---------------|--|--|---|
| 4 | Utility Jacket | Embroidered in colour on khaki background | |
| 5 | Mess Dress | Embroidered bullion badge in miniature size in gold and silver on blue/black backing for officers only | Badge optional for officers, IAW Annex 4O |
| 6 | Mess Dress Army, Senior Ranks Mess Dress and Mess Dress White Jacket | Full size embroidered badge on black/white background | |
| 7 | Mess Dress and Mess Dress White Jacket | Full size embroidered badge on black/white background | |
| 8 | Band Ceremonial Dress | Embroidered in colour on scarlet/blue/white background | |
| 9 | Patrol Blue orders of dress | Embroidered in colour on blue/white background | |

AL5

OFFICIAL

OPERATOR PETROLEUM

DESCRIPTION

1. The Operator Petroleum (OP PET) Badge depicts an Archaeopteryx (Latin for Ancient Bird), as shown in Figure 4O11-1 and Figure 4O11-2.

Figure 4O11-1: Operator Petroleum Badge



Figure 4O11-2: Operator Petroleum Badge khaki background



ELIGIBILITY

2. The badge is to be worn by a RAAOC Officer on completion of the British Officers Petroleum Course or US Petroleum Officers course and members who have qualified as OP PET Employment Category Number (ECN) 269, Handler Petroleum ECN 282 Mod 1 and 2 Course, ECN 282-2 and 269-1, in accordance with (IAW) RAAOC policy.

WEARING THE BADGE

3. The item of dress and the type of badge to be worn with the particular garment is in Table 4O11-1. The badge is not worn on any item that is not listed in Table 4O11-1.

Table 4O11-1: Wearing the Operator Petroleum Badge

| Serial | Dress | Badge | Remarks |
|---------------|--|--|---|
| 1 | Service Dress | Embroidered in colour on khaki background | |
| 2 | Shirt Khaki Polyester | Embroidered in colour on khaki background | |
| 3 | Safari Suit Jacket | Embroidered in colour on khaki background | Officers only |
| 4 | Utility Jacket | Embroidered in colour on khaki background | |
| 5 | Mess Dress | Embroidered bullion badge in miniature size in gold and silver on blue/black backing for officers only | Badge optional for officers, IAW Annex 4O |
| 6 | Mess Dress Army, Senior Ranks Mess Dress and Mess Dress White Jacket | Full size embroidered badge on black/white background | |
| 7 | Patrol Blue orders of dress | Embroidered in colour on blue/white background | |

PARACHUTE RIGGER

DESCRIPTION

1. The Parachute Rigger Badge depicts a parachute surmounted by a boomerang with the word 'RIGGER' and contained in a wattle wreath, as shown in Figure 4O12-1.

Figure 4O12-1: Parachute Rigger Badge



ELIGIBILITY

2. The badge is to be worn by a member who has qualified as a parachute rigger, in accordance with (IAW) Royal Australian Army Ordnance Corps policy.

WEARING THE BADGE

3. The item of dress and the type of badge to be worn with the particular garment is in Table 4O12-1. The badge is not worn on any item that is not listed in Table 4O12-1.

Table 4O12-1: Wearing the Parachute Rigger Badge

| Serial | Dress | Badge | Remarks |
|--------|-----------------------|---|---------------|
| 1 | Service Dress | Embroidered in colour on khaki background | |
| 2 | Shirt Khaki Polyester | Embroidered in colour on khaki background | |
| 3 | Safari Suit Jacket | Embroidered in colour on khaki background | Officers only |

OFFICIAL

ADM

4O12-2

| Serial | Dress | Badge | Remarks |
|---------------|--|--|---|
| 4 | Utility Jacket | Embroidered in colour on khaki background | |
| 5 | Mess Dress | Embroidered bullion badge in miniature size in gold and silver on blue/black backing for officers only | Badge optional for officers, IAW Annex 4O |
| 6 | Mess Dress Army, Senior Ranks Mess Dress and Mess Dress White Jacket | Full size embroidered badge on black/white background | |
| 7 | Patrol Blue orders of dress | Embroidered in colour on blue/white background | |

AL5

OFFICIAL

PIPER

DESCRIPTION

1. The Piper Badge depicts a set of pipes, as shown in Figure 4O13–1.

Figure 4O13–1: Piper Badge



ELIGIBILITY

2. The badge is to be worn by a member who has qualified as a piper, in accordance with (IAW) AABC policy.

WEARING THE BADGE

3. The item of dress and the type of badge to be worn with the particular garment is in Table 4O13–1. The badge is not worn on any item that is not listed in Table 4O13–1.

Table 4O13–1: Wearing the Piper Badge

| Serial | Dress | Badge | Remarks |
|---------------|-----------------------|---|----------------|
| 1 | Service Dress | Embroidered in colour on khaki background | |
| 2 | Shirt Khaki Polyester | Embroidered in colour on khaki background | |

OFFICIAL

ADM

4O13-2

| Serial | Dress | Badge | Remarks |
|---------------|--|--|---|
| 3 | Safari Suit Jacket | Embroidered in colour on khaki background | Officers only |
| 4 | Utility Jacket | Embroidered in colour on khaki background | |
| 5 | Mess Dress | Embroidered bullion badge in miniature size in gold and silver on blue/black backing for officers only | Badge optional for officers, IAW Annex 4O |
| 6 | Mess Dress Army, Senior Ranks Mess Dress and Mess Dress White Jacket | Full size embroidered badge on black/white background | |
| 7 | Patrol Blue orders of dress | Embroidered in colour on blue/white background | |
| 8 | Band Ceremonial Dress | Embroidered in colour on scarlet/white/green background | |

AL5

OFFICIAL

PHYSICAL TRAINING INSTRUCTOR

DESCRIPTION

1. The Physical Training Instructor (PTI) Badge depicts the letters 'PTI' surrounded by a wreath, as shown in Figure 4O14–1.

Figure 4O14–1: Physical Training Instructor Badge



ELIGIBILITY

2. The badge may be worn by a member who has qualified as a PTI, in accordance with (IAW) Royal Australian Army Medical Corps policy.

WEARING THE BADGE

3. The item of dress and the type of badge to be worn with the particular garment is in Table 4O14–1. The badge is not worn on any item that is not listed in Table 4O14–1.

Table 4O14–1: Wearing the PTI Badge

| Serial | Dress | Badge | Remarks |
|--------|-----------------------|---|---------------|
| 1 | Service Dress | Embroidered in colour on khaki background | |
| 2 | Shirt Khaki Polyester | Embroidered in colour on khaki background | |
| 3 | Safari Suit Jacket | Embroidered in colour on khaki background | Officers only |

OFFICIAL

ADM

4O14-2

| Serial | Dress | Badge | Remarks |
|---------------|--|--|---|
| 4 | Utility Jacket | Embroidered in colour on khaki background | |
| 5 | Mess Dress | Embroidered bullion badge in miniature size in gold and silver on blue/black backing for officers only | Badge optional for officers, IAW Annex 4O |
| 6 | Mess Dress Army, Senior Ranks Mess Dress and Mess Dress White Jacket | Full size embroidered badge on black/white background | |
| 7 | Patrol Blue orders of dress | Embroidered in colour on blue/white background | |
| 8 | Physical Training Dress | Embroidered in colour on white background | |

AL5

OFFICIAL

UNIT AND GROUP CITATIONS

WEARING THE AWARD

1. Emblems of Unit and Group Citations and awards are worn with ceremonial and general duty orders of dress and Safari Suit jacket on which medals or medal ribbons are worn. If issued, miniature embellishments are worn with mess dress orders of dress.
2. Personnel awarded the Group Bravery Citation or posted to a unit for the period that a unit citation was awarded may wear the emblem with civilian jacket or coat when wearing orders, decorations and medals.
3. The embellishment is not worn on Australian Multi-cam Camouflage Uniform (AMCU), Garrison jacket, raincoat, overcoat or any form of Protective Dress.

ELIGIBILITY TO WEAR UNIT CITATION FOR GALLANTRY AND MERITORIOUS UNIT CITATION

4. Personnel who were members of the unit for when the award was made wear the insignia with a Federation Star 7 mm in diameter, in the same finish as the frame. These personnel continue to wear the insignia after leaving the unit. Personnel who are posted to a unit that has been awarded Australian Unit Citations, but who were not members of the unit at the time the award was made, wear the insignia without the Federation Star whilst posted to the unit. The insignia is returned to the unit when they leave.

ELIGIBILITY TO WEAR THE GROUP BRAVERY CITATION

5. A group of personnel who have been awarded for a collective act of bravery in extraordinary circumstances and signed off by the Governor General and the Australian Decorations' Advisory Committee.

MULTIPLE CITATIONS

6. Only one insignia of each citation with Federation Star can be worn.
7. A maximum of four insignia can be worn and are only to be worn in a single row.
8. There is no device to represent multiple awards of Australian citations.

PRECEDENCE OF CITATIONS

9. Although the Group Bravery Citation or unit citations are not mentioned in the official order of wearing of honours and awards, the Unit Citation for Gallantry (UCG) is to take precedence over the Group Bravery Citation (GBC) followed by the Meritorious Unit Citation (MUC), irrespective of whether or not a Federation Star is worn. These Australian citations take precedence over foreign nation unit citations. Foreign awards are worn after Australian awards and are worn in the order of the

date awarded except that if two or more awards by one nation are worn, awards are placed in the order of precedence determined by that nation. Existing awards are in Figure 4P-1, in correct precedence as viewed facing the wearer.

Figure 4P-1: Emblems of Awards in Order of Precedence

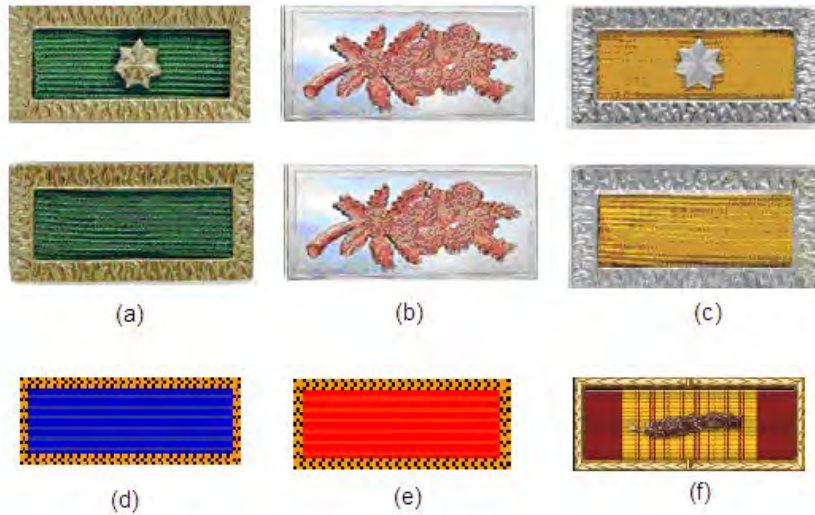

10. The emblems in Figure 4P-1 are:
 - a. UCG (Australia), with Federation Star to indicate the wearer was present at the action, without Federation Star worn by member of a unit awarded UCG
 - b. GBC (Australia)
 - c. MUC (Australia); with Federation Star to indicate the wearer was present at the action without Federation Star worn by member of a unit awarded UCG
 - d. US Presidential Unit Citation
 - e. US Meritorious Unit Commendation (Army)
 - f. Republic of Vietnamese Gallantry Cross with Palm Unit Citation.

POSITIONING THE AWARD

11. Emblems of Unit Citations and awards are worn on the right breast, 1 cm above the Army Individual Readiness Notification (AIRN) Badge, in accordance with (IAW) Figure 4P-2.

12. Where a member is entitled to wear an emblem of a Unit Citation, Group Bravery Citation or award and a medal of an unofficial award, the ribbon of the unofficial award is to be worn 1 cm above the AIRN Badge with the unit award on a separate row 3 mm above the top of the medal ribbon of the unofficial award, IAW Figure 4P-3. Unofficial awards are worn IAW [Chapter 6](#).

FOREIGN UNIT COMMENDATIONS AND COMMENDATIONS

13. Personnel awarded the US Meritorious Unit Commendation (Army) for service with both the Australian Army Training Team Vietnam and 1 Royal Australian Regiment (RAR) Group wear an oak leaf cluster on their citation. The cluster is also worn on the US Presidential Unit Citation by entitled personnel who served with 3 RAR, D Coy, 6 RAR and 105 Bty, Royal Australian Artillery (RAA).

14. Unit citations awarded Australian Army members while serving with allied forces. Personnel who have served with an allied unit that was awarded a unit citation may apply to DGAPC for permission to wear the insignia of the award on Army uniform. Unit citations are considered a uniform embellishment so do not require approval from Defence Honours and Awards. Applications are to include all supporting documentation. Each application will be assessed on a case-by-case basis but usually only service that would attract recognition by an Australian citation or commendation will be approved fig4P-2 to 4P-4.

15. The following United States Defence Force Unit Commendations may be approved for wear by Army members Fig4P-2 to 4P-4.

- a. Presidential Unit Citation (Navy/USMC, Army, USAF)
- b. Navy Unit Commendation (Navy/USMC)
- c. Valorous Unit Award (Army)
- d. Gallant Unit Citation (USAF)
- e. Meritorious Unit Commendation (Navy/USMC, Army, USAF)
- f. Superior Unit Award (Army)
- g. Air Force Outstanding Unit Award

Figure 4P-2: US Navy/Marine Corps Unit Awards



Figure 4P-3: US Army Unit Awards



Figure 4P-4: US Air Force and Space Force Unit Awards



16. Awards that are restricted to US Armed Forces personnel only (eg Joint Meritorious Unit Award) cannot be approved for wear with Army uniform unless the recipient was a member of the US Armed Forces at the time of the award. This Award is not awarded to foreign members regardless of force assignment.

17. Australian Army members awarded the New Zealand Chief of The Defence Force and Chief of Army Commendation whilst attached to the NZDF, may apply to DGAPC for permission to wear the insignia on Army uniform. Applications are to include all supporting documentation. Each application will be assessed on a case-by-case basis but usually only service that would attract recognition by an Australian citation or commendation will be approved. Fig 4P-5.

- a. Chief of the Defence Force (New Zealand)
- b. Chief of Navy
- c. Chief of Army
- d. Chief of Air Force

Figure 4P-5: NZDF Individual Commendations



18. Australian Army members awarded the Canadian Chief of The Defence Force Staff commendation and Command Commendation whilst attached to the Canadian Armed Forces, may apply to DGAPC for permission to wear the insignia on Army uniform. Applications are to include all supporting documentation. Each application will be assessed on a case-by-case basis but usually only service that would attract recognition by an Australian citation or commendation will be approved. These are individual commendations and worn in the same manner as Australian awards but after. They are worn in the order of the date awarded except that if two or more awards by one nation are worn, awards are placed in the order of precedence determined by that nation Fig 4P-6.

ADM

4P-5

- a. Canadian Chief of The Defence Force Staff commendation
- b. Command Commendation

Figure 4P-6: CAF Individual Commendations



19. The cluster is worn horizontally in the centre of the award, with the larger part of the cluster facing to the right.

Figure 4P-7: Positioning the Unit/Group Citation Emblem(s)

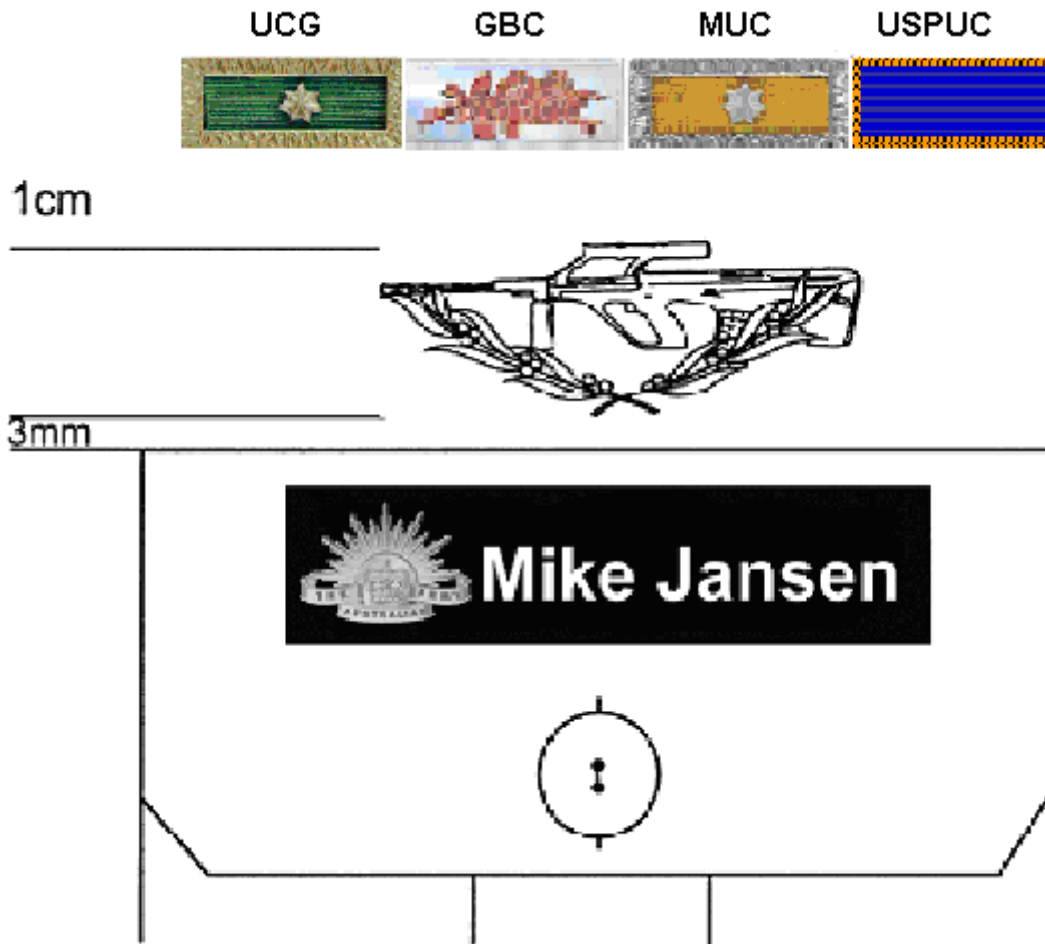

RESTRICTED WEAR OF AWARDS

20. Awards of the states, territories, Commonwealth departments and Non-Government Organisations (NGO) may be accepted by Army members but are only to be worn on a restricted basis with Army uniform or when in civilian attire on official duty.

21. State, territory and departmental awards. The Australian states and territories have instituted a range of awards to recognise service and achievement of members of state and territory organisations, these include long service and bravery awards for police, ambulance, emergency service and corrective service personnel. Some Australian Commonwealth government departments such as the Australian Federal Police and the Australian Border Protection Force have also instituted awards to recognise dedicated or worthy service. These awards are not included in the Australian Honours system so are not to be worn with Army uniform. 5.68 The two exceptions the above rule are:

- a. When a member is posted or seconded to a Commonwealth department or state/territory organisation, they may wear the insignia for the duration of their tour. Example: A member seconded to NSW Police Air Wing who is awarded a NSW Police Commissioners Commendation, may wear the insignia of that award until their tour ceases.
- b. When a member attends an official function or event conducted by that state/territory government or Commonwealth department.

Example 1: Wearing the Australian Capital Territory (ACT) Emergency medal at a 2003 bushfire commemoration service conducted by the ACT government.

Example 2: If attending a police Memorial Day service in Queensland, wearing the Queensland Police Service G20 citation is appropriate.

22. Non-government organisation awards. Various NGOs present awards for saving of life, bravery and other worthy actions. This includes awards from the Royal Humane Society, the Royal Life Saving Society, the Red Cross Society and other philanthropic organisations. These awards do not form part of the Australian Honours system so are not to be worn with Army uniform.

23. Method of wear. On appropriate occasion's state/territory, departmental and NGO awards are to be worn above the right breast pocket after or below all awards approved by the Federal Government. Where a medal is worn (such as the ACT Emergency Medal) the medal is placed immediately above the right pocket and 10mm above the AIRN Figure 4L-20.

24. Civilian attire. When in civilian attire and acting in a private capacity, members may wear on the right side any departmental, state/territory and/or NGO awards they have been presented. Awards would be placed after or underneath any unit citations. Precedence would be Commonwealth department awards, state/territory awards and then NGO awards.

25. When in civilian attire and on official duty, members are to adhere to the same restricted wear rules as for the Army uniform.

26. Unofficial awards. The awards approved for restricted wear does not include medals and insignia purchased from private retailers or organisations. Purchased awards are not to be worn on Army uniform at any time. Likewise medals, ribbons or other insignia awarded as a prize or for participation in a competition are not to be worn on Army uniform.

Figure 4P-8: Unit/Group Citation Emblems with Restricted wear Award

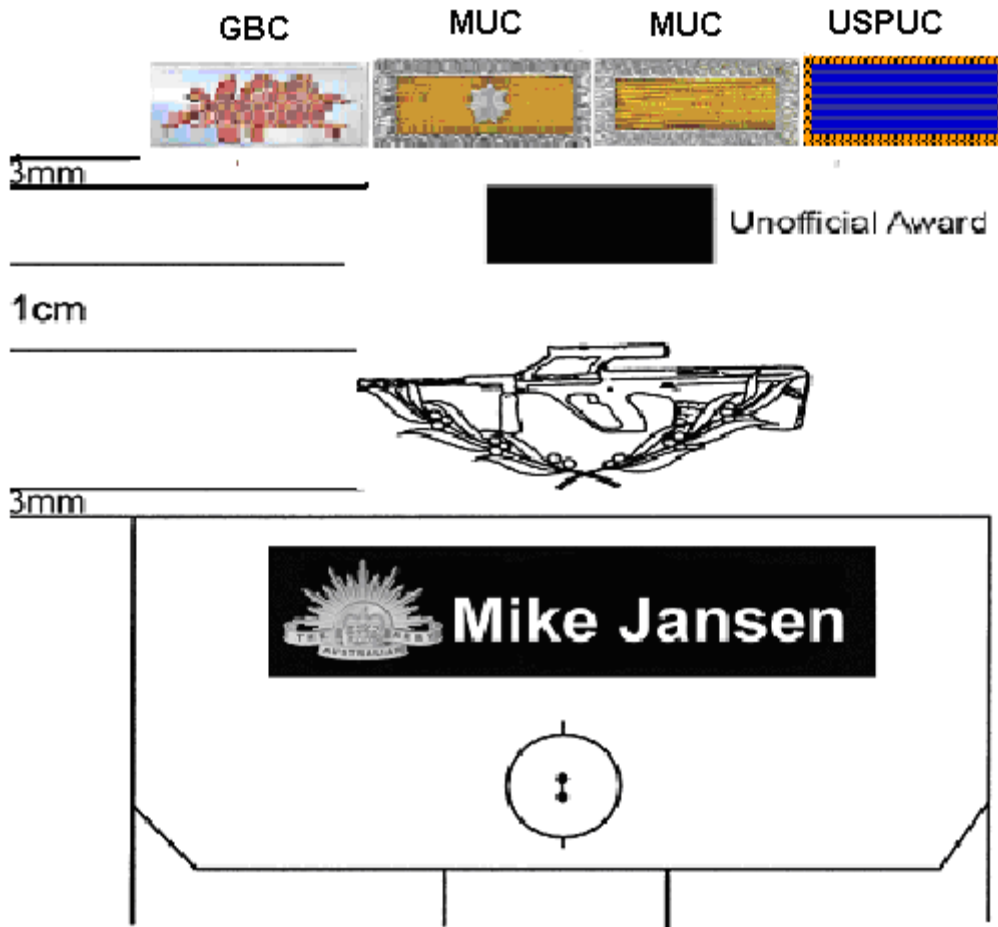

27. Miniature emblems are worn on the right lapel of mess dress orders of dress, IAW [Annex 5O](#). The Group Bravery Citation or US Navy Citations are not worn on mess dress as they do not have a miniature emblem.

CHAPTER 5

INTERPRETATION OF THE ARMY DRESS MANUAL

The Army Dress Manual is to be interpreted as positive instructions, meaning if a situation is **not** specified in the Army Dress Manual, it is therefore **prohibited**; however, elements of this manual provide specific direction to the reader.

ORDERS OF DRESS

GENERAL

5.1 The ceremonial parade, ceremonial, general duty, field, mess and protective dress orders of dress are in this chapter.

5.2 The orders of dress are identified by Dress Number and Dress Title. With each order there is little or no option. When advising the order of dress on invitations and in instructions the Dress Number and Dress Title are to be used.

WOMEN WEARING THE AUSTRALIAN ARMY UNIFORM

5.3 The following general points are made for women wearing the Australian Army uniform.

- a. Skirts are an optional alternative to trousers in ceremonial, general duty and mess dress orders of dress, but not Ceremonial Parade Dress.
- b. Trousers are to be worn when arms and swords are carried.
- c. When wearing skirts, stockings or pantihose are optional with all orders of dress. Footlets are to be worn when not wearing stockings or pantihose. Footlets are defined as nylon covers for feet which do not extend above the ankle.
- d. Court shoes can be worn with either skirts or trousers.
- e. Khaki socks are to be worn with boots and shoes when wearing trousers.

ORDERS OF DRESS

5.4 Orders of dress are in Table 5–1.

Table 5–1: Orders of Dress

| Dress Number | Dress Order Title | Table |
|--------------|---------------------------------|-------|
| 1 | Service Dress all seasons | |
| 1A | Ceremonial Parade Service Dress | 5–2 |
| 1B | Ceremonial Service Dress | 5–3 |

| Dress Number | Dress Order Title | Table |
|--------------|--|-------|
| 1C | General Duty Service Dress | 5-4 |
| 2 | Polyester Dress | |
| 2A | Ceremonial Parade Dress | 5-5 |
| 2B | Ceremonial Parade Dress Cold Weather | 5-6 |
| 2C | Ceremonial Dress | 5-7 |
| 2D | Ceremonial Dress Cold weather | 5-8 |
| 2E | General Duty Dress (polyesters) | 5-9 |
| 2F | General Duty Dress Cold weather | 5-10 |
| 2G | General Duty Office Dress | 5-11 |
| 3 | Safari Suit | |
| 3A | Ceremonial Safari Suit | 5-12 |
| 4 | Australian Multi-cam Camouflage Uniform (AMCU) | |
| 4A | General Duty Dress (AMCU)/Dress of the day | 5-13 |
| 4B | Field Dress (AMCU) | 5-14 |
| 4C | Combat Dress (AMCU) | 5-15 |
| 5 | Armoured Fighting Vehicle (AFV) crewman dress | |
| 5A | Ceremonial Parade Dress AFV Crewman | 5-16 |
| 5B | AFV Crewman—Tank Suit | 5-17 |
| 6 | Mess Dress | |
| 6A | Mess Dress | 5-18 |
| 6B | Mess Dress White Jacket | 5-19 |
| 6C | Senior Ranks Mess Dress | 5-20 |
| 6D | Mess Dress Army | 5-21 |
| 7 | Working/Protective Dress | 5-22 |
| 8 | Maternity Dress | 5-23 |
| 9 | Aircrew Flying Dress | 5-24 |

5.5 The orders of dress Worn on Particular Occasions are in [Annex 5A](#).

5.6 The orders of dress for Special Appointments/Selected Personnel are in [Annex 5B](#).

5.7 The orders for dress for Senior Officer Dress are in [Annex 5C](#).

5.8 The orders for dress for Band Ceremonial Dress are in [Annex 5D](#).

5.9 The orders for dress for Scottish Dress are in [Annex 5E](#).

5.10 The orders for dress for Chaplain Dress are in [Annex 5F](#).

- 5.11 The orders for dress for Army Emergency Response Dress are in [Annex 5G](#).
- 5.12 The orders for dress for Military Equestrian Dress are in [Annex 5H](#).
- 5.13 The orders for dress for Australian Defence Force Academy (ADFA) Dress are in [Annex 5I](#).
- 5.14 The orders for dress for Royal Military College (RMC) Dress are in [Annex 5J](#).
- 5.15 The orders for dress for Physical Training Instructor (PTI) Dress are in [Annex 5K](#).
- 5.16 The orders for dress for Medical/Dental and Nursing Dress are in [Annex 5L](#).
- 5.17 The orders for dress for Military Police (MP) Dress are in [Annex 5M](#).
- 5.18 The orders for dress for Catering Dress are in [Annex 5N](#).
- 5.19 The orders for dress for Mess Dress are in [Annex 5O](#).
- 5.20 The orders for dress for Tri-Service equivalencies are in [Annex 5P](#).

DRESS ORDER NO 1A ‘CEREMONIAL PARADE SERVICE DRESS’

5.21 This order of dress is the ceremonial parade dress, including mounted parades, other than AFV parades, when the wearing of a jacket is appropriate. It consists of the following items of dress:

Table 5–2: Dress Order No 1A ‘Ceremonial Parade Service Dress’

| Serial | Item of Dress | Remarks |
|--------|--|---|
| 1 | Australian Army Rising Sun Badge embroidered on khaki background | |
| 2 | Badge Army Individual Readiness Notification (AIRN) | If qualified |
| 3 | Badge commendation or soldiers medallion | If awarded |
| 4 | Badge Army Combat Badge (ACB) / Infantry Combat Badge (ICB) / Military Instructor Badge (MIB) / Recruit Instructor Badge (RIB) | If presented/awarded |
| 5 | Bandolier | Note (a) |
| 6 | Belt black | |
| 7 | Belt khaki 32 mm | Worn if the jacket is removed |
| 8 | Belt white | Australian Federation Guard (AFG), RMC, ADFA, Royal Australian Corps of Military Police (RACMP) units when on parade and Colour Escorts ^{Note (b)} |
| 9 | Belt Sam Browne and shoulder strap | Note (c) |

| Serial | Item of Dress | Remarks |
|--------|---|--|
| 10 | Emblems of unit citation and/or awards | If awarded |
| 11 | Gauntlets white | AABC Drum Major, cymbal players and bass drummer only |
| 12 | Gloves leather brown/black | Note (d) |
| 13 | Hat Khaki Fur Felt (KFF) with appropriate hat badge | Brim up |
| 14 | Jacket Service dress | Line 40 and Line 30 Australian Army Rising Sun buttons |
| 15 | Lanyard, collar badges and insignia shoulder, 'AUSTRALIA' | |
| 16 | Necktie khaki polyester | |
| 17 | Orders, decorations and medals | If awarded |
| 18 | R.M. Williams elastic sided, black leather boots | Note (e) |
| 19 | Rank insignia | Officer rank to be pinned to epaulette |
| 20 | Sash Drum Major | Note (f) |
| 21 | Sash scarlet | Note (g) |
| 22 | Shirt polyester long sleeve | |
| 23 | Socks khaki | |
| 24 | Sword and accessories | Note (c) |
| 25 | Trade/skill qualification badge | Note (h) |
| 26 | Trousers Service dress | |

Notes:

- (a) Worn by members posted to a Royal Australian Armoured Corps unit when carrying Lances.
- (b) When worn, white sling is to be used if carrying weapons.
- (c) Officers and WO1. For Senior officers, in accordance with (IAW) [Annex 5C](#).
- (d) Worn by officers and ORs when ordered.
- (e) The issued R.M. Williams elastic sided, black leather boot is to be worn with ceremonial orders of dress (on parade), General Duty Dress (polyesters), General Duty Service Dress and mess dress orders of dress.
- (f) Worn by AABC Drum Major only.
- (g) RA Inf WO2 and Senior Non-Commissioned Officers, and authorised members of the Corps of Staff Cadets and other than Corps of Staff Cadets.
- (h) Only worn by those qualified members, IAW [Annex 4O](#).

**Figure 5-1: Dress Order No 1A 'Ceremonial Parade Service Dress'
(Other Ranks)**



Figure 5-2: Dress Order No 1A 'Ceremonial Parade Service Dress' (Non-Commissioned Officer)



Figure 5-3: Dress Order No 1A 'Ceremonial Parade Service Dress' (Officer)



DRESS ORDER NO 1B ‘CEREMONIAL SERVICE DRESS’

5.22 This order of dress may be worn by spectators at ceremonial parades and other occasions when ceremonial service dress is appropriate. It consists of the following items of dress:

Table 5–3: Dress Order No 1B ‘Ceremonial Service Dress’

| Serial | Item of Dress | Remarks |
|---------------|---|--|
| 1 | Australian Army Rising Sun Badge embroidered on khaki background | |
| 2 | Badge AIRN | If qualified |
| 3 | Badge commendation or soldiers medallion | If awarded |
| 4 | Badge ACB/ICB/MIB/RIB | If presented/awarded |
| 5 | Belt black | |
| 6 | Belt khaki 32 mm | Worn if the jacket is removed |
| 7 | Belt white | AFG, RMC, ADFA, RACMP units |
| 8 | Belt Sam Browne and shoulder strap | Note (a) |
| 9 | Emblems of unit citation and/or awards | If awarded |
| 10 | Gloves leather brown/black | Note (b) |
| 11 | Hat KFF with appropriate hat badge | Brim up |
| 12 | Jacket Service dress | Line 40 and Line 30 Australian Army Rising Sun buttons |
| 13 | Lanyard, collar badges and insignia shoulder, ‘AUSTRALIA’ | |
| 14 | Nameplate | IAW Chapter 3 |
| 15 | Necktie khaki polyester | |
| 16 | Orders, decorations and medals | If awarded Note (g) |
| 17 | Black Court shoes or R.M. Williams elastic sided, black leather boots | Notes (c) and (d) |
| 18 | Rank insignia | Officer rank to be pinned to epaulette |
| 19 | Sash scarlet | Note (e) |
| 20 | Shirt polyester long sleeve | |
| 21 | Skirt Service dress | |
| 22 | Socks khaki | |
| 23 | Trade/skill qualification badge | Note (f) |
| 24 | Trousers Service dress | |

Notes:

- (a) Officers and WO1. For Senior officers, IAW [Annex 5C](#).
- (b) Worn by officers and ORs when ordered.
- (c) The issued R.M. Williams elastic sided, black leather boot is to be worn with ceremonial orders of dress (on parade), General Duty Dress (polyesters), General Duty Service Dress and mess dress orders of dress.
- (d) When trousers are worn, women can either wear Court shoes or the issued R.M. Williams elastic sided, black leather boot. R.M. Williams elastic sided, black leather boot are not to be worn by female spectators whilst wearing skirt polyester.
- (e) RA Inf WO2 and SNCO, and authorised members of the Corps of Staff Cadets and OCDTs.
- (f) Only worn by those qualified members, IAW [Annex 4O](#).
- (g) Ribbons to be worn by members receiving awards at an investiture ceremony.

Figure 5-4: Dress Order No 1B 'Ceremonial Service Dress' (Other Ranks)



Figure 5-5: Dress Order No 1B 'Ceremonial Service Dress' (Non-Commissioned Officer)



Figure 5-6: Dress Order No 1B 'Ceremonial Service Dress' (Officer)



DRESS ORDER NO 1C 'GENERAL DUTY SERVICE DRESS'

5.23 This is an order of dress which may be worn as an optional general duty dress at the discretion of individuals. It consists of the following items of dress:

Table 5-4: Dress Order No 1C 'General Duty Service Dress'

| Serial | Item of Dress | Remarks |
|--------|--|--|
| 1 | Australian Army Rising Sun Badge embroidered on khaki background | |
| 2 | Badge AIRN | If qualified |
| 3 | Badge commendation or soldiers medallion | If awarded |
| 4 | Badge ACB/ICB/MIB/RIB | If presented/awarded |
| 5 | Belt khaki 32 mm | Worn if the jacket is removed |
| 6 | Belt Sam Browne and shoulder strap | Note (a) |
| 7 | Beret Corps/Regiment/Unit with appropriate hat badge | Note (b) |
| 8 | Emblems of unit citation and/or awards | If awarded |
| 9 | Hat KFF with appropriate hat badge | Brim down |
| 10 | Jacket Service dress | Line 40 and Line 30 Australian Army Rising Sun buttons |
| 11 | Lanyard, collar badges and insignia shoulder, 'AUSTRALIA' | |
| 12 | Nameplate | IAW Chapter 3 |
| 13 | Necktie khaki polyester | |
| 14 | Black Court shoes or R.M. Williams elastic sided black leather boots | Notes (c) and (d) |
| 15 | Rank insignia | Officer rank to be pinned to epaulette |
| 16 | Ribbons of orders, decorations and medals | If awarded |
| 17 | Shirt polyester long sleeve | |
| 18 | Skirt Service dress | For women: stockings/pantihose are to be worn |
| 19 | Socks khaki | |
| 20 | Trade/skill qualification badge | Note (e) |
| 21 | Trousers Service dress | |

Notes:

- (a) ADJTs and RSMs are to wear the Sam Browne Belt, IAW [Chapter 3](#).
- (b) Berets are to be worn, IAW [Chapter 3](#).

ADM

5-14

- (c) The issued R.M. Williams elastic sided, black leather boots may be worn when with ceremonial orders of dress (on parade), General Duty Dress (polyesters), General Duty Service Dress and mess dress orders of dress.
- (d) When trousers are worn, women can either wear Court shoes or the issued R.M. Williams Elastic sided black leather boot. R.M. Williams elastic sided, black leather boot are not to be worn whilst wearing skirt polyester.
- (e) Only worn by those qualified members, IAW [Annex 40](#).

Figure 5-7: Dress Order No 1C 'General Duty Service Dress' (Other Ranks)



Figure 5-8: Dress Order No 1C 'General Duty Service Dress' (Non-Commissioned Officer)



Figure 5-9: Dress Order No 1C 'General Duty Service Dress' (Officer)



DRESS ORDER NO 2A 'CEREMONIAL PARADE DRESS'

5.24 This order of dress is the ceremonial dress for all ranks, including the reviewing officer, the host officer and officers being received on parade. It consists of the following items of dress:

Table 5-5: Dress Order No 2A 'Ceremonial Parade Dress'

| Serial | Item of Dress | Remarks |
|--------|--|--|
| 1 | Australian Army Rising Sun Badge embroidered on khaki background | |
| 2 | Badge AIRN | If qualified |
| 3 | Badge commendation or soldiers medallion | If awarded |
| 4 | Badge ACB/ICB/MIB/RIB | If presented/awarded |
| 5 | Bandolier | Note (a) |
| 6 | Belt black and belt hooks | |
| 7 | Belt white | AFG, RMC, ADFA RACMP units when on parade and Colour Escorts ^{Note (b)} |
| 8 | Belt Sam Browne, shoulder strap and belt hooks | Note (c) |
| 9 | Boards shoulder khaki | Officer and OCDT/SCDT |
| 10 | Emblems of unit citation and/or awards | If awarded |
| 11 | Gauntlets white | AABC Drum Major, cymbal players and bass drummer only |
| 12 | Hat KFF with appropriate hat badge | Brim up |
| 13 | Lanyard and appropriate insignia shoulder | |
| 14 | Orders, decorations and medals | If awarded |
| 15 | R.M. Williams elastic sided, black leather boots | Note (d) |
| 16 | Rank insignia | Officer rank to be pinned to board shoulder khaki |
| 17 | Sash Drum Major | Note (e) |
| 18 | Sash scarlet | Note (f) |
| 19 | Shirt polyester short sleeve | |
| 20 | Socks khaki | |
| 21 | Sword and accessories | Note (c) |
| 22 | Trade/skill qualification badge | Note (g) |
| 23 | Trousers polyester | |

Notes:

(a) Worn by members posted to a RAAC unit when carrying Lances.

ADM

5-18

- (b) When worn, white sling is to be used if carrying weapons.
- (c) Officers and WO1. For Senior officers, IAW [Annex 5C](#).
- (d) The issued R.M. Williams elastic sided, black leather boots may be worn when with ceremonial orders of dress (on parade), General Duty Dress (polyesters), General Duty Service Dress and mess dress orders of dress.
- (e) Worn by AABC Drum Major only.
- (f) RA Inf WO2 and SNCO, and authorised members of the Corps of Staff Cadets and OCDTs.
- (g) Only worn by those qualified members, IAW [Annex 4O](#).

Figure 5-10: Dress Order No 2A 'Ceremonial Parade Dress' (OR)



Figure 5-11: Dress Order No 2A 'Ceremonial Parade Dress' (Non-Commissioned Officer)



Figure 5-12: Dress Order No 2A 'Ceremonial Parade Dress' (Officer)



DRESS ORDER NO 2B 'CEREMONIAL PARADE DRESS COLD WEATHER'

5.25 This order of dress is the ceremonial dress for all ranks, including the reviewing officer, the host officer and other officers being received on parade. This order of dress is worn on ceremonial parades including mounted parades other than AFV parades when, Dress Order No 1A—Ceremonial Parade Service Dress has not been issued and the climate dictates. It consists of the following items of dress:

Table 5-6: Dress Order No 2B 'Ceremonial Parade Dress Cold Weather'

| Serial | Item of Dress | Remarks |
|--------|--|---|
| 1 | Australian Army Rising Sun Badge embroidered on khaki background | |
| 2 | Badge AIRN | If qualified |
| 3 | Badge commendation or soldiers medallion | If awarded |
| 4 | Badge ACB/ICB/MIB/RIB | If presented/awarded |
| 5 | Bandolier | Note (a) |
| 6 | Belt black and belt hooks | |
| 7 | Belt white | AFG, RMC, ADFA, RACMP units when on parade and Colour Escorts ^{Note (b)} |
| 8 | Belt Sam Browne, shoulder strap and belt hooks | Note (c) |
| 9 | Boards shoulder khaki | Officer and OCDT/SCDT |
| 10 | Emblems of unit citation and/or awards | If awarded |
| 11 | Hat KFF with appropriate hat badge | Brim up |
| 12 | Lanyard and appropriate insignia shoulder | |
| 13 | Necktie khaki polyester | |
| 14 | Orders, decorations and medals | If awarded |
| 15 | R.M. Williams elastic sided, black leather boots | Note (d) |
| 16 | Rank insignia | Officer rank to be pinned to board shoulder khaki |
| 17 | Sash scarlet | Note (e) |
| 18 | Shirt polyester long sleeve | Note (f) |
| 19 | Socks khaki | |
| 20 | Sword and accessories | Note (c) |
| 21 | Trade/skill qualification badge | Note (g) |
| 22 | Trousers polyester | |

Notes:

(a) Worn by members posted to a RAAC unit when carrying Lances.

- (b) When worn, white sling is to be used if carrying weapons.
- (c) Officers and WO1. For Senior officers, IAW [Annex 5C](#).
- (d) The issued R.M. Williams elastic sided, black leather boots may be worn when with ceremonial orders of dress (on parade), General Duty Dress (polyesters), General Duty Service Dress and mess dress orders of dress.
- (e) RA Inf WO2 and SNCO, and authorised members of the Corps of Staff Cadets and OCDTs.
- (f) Thermal underwear may be worn in cold weather.
- (g) Only worn by those qualified members, IAW [Annex 4O](#).

Figure 5-13: Dress Order No 2B 'Ceremonial Parade Dress Cold Weather' (Non-Commissioned Officer)



Figure 5-14: Dress Order No 2B 'Ceremonial Parade Dress Cold Weather' (Officer)



DRESS ORDER NO 2C 'CEREMONIAL DRESS'

5.26 This order of dress may be worn by spectators at ceremonial parades and other occasions when ceremonial dress is ordered. It consists of the following items of dress:

Table 5-7: Dress Order No 2C 'Ceremonial Dress'

| Serial | Item of Dress | Remarks |
|--------|---|---|
| 1 | Australian Army Rising Sun Badge embroidered on khaki background | |
| 2 | Badge AIRN | If qualified |
| 3 | Badge commendation or soldiers medallion | If awarded |
| 4 | Badge ACB/ICB/MIB/RIB | If presented/awarded |
| 5 | Belt black and belt hooks | |
| 6 | Belt white | AFG, RMC, ADFA, RACMP units |
| 7 | Belt Sam Browne, shoulder strap and belt hooks | Note (a) |
| 8 | Boards shoulder khaki | Officer and OCDT/SCDT |
| 9 | Emblems of unit citation and/or awards | If awarded |
| 10 | Hat KFF with appropriate hat badge | Brim up |
| 11 | Lanyard and appropriate insignia shoulder | |
| 12 | Nameplate | |
| 13 | Orders, decorations and medals | If awarded |
| 14 | Black Court shoes or R.M. Williams elastic sided, black leather boots | Notes (b) and (c) |
| 15 | Rank insignia | Officer rank to be pinned to board shoulder khaki |
| 16 | Sash scarlet | Note (d) |
| 17 | Shirt short sleeve polyester | |
| 18 | Skirt polyester | As a Spectators only |
| 19 | Socks khaki | |
| 20 | Trade/skill qualification badge | Note (e) |
| 21 | Trousers polyester | |

Notes:

- (a) Officers and WO1. For Senior officers, IAW [Annex 5C](#).
- (b) The issued R.M. Williams Elastic sided black leather boots may be worn when with ceremonial orders of dress (on parade), General Duty Dress (polyesters), General Duty Service Dress and mess dress orders of dress.
- (c) R.M. Williams elastic sided, black leather boot are not to be worn by female spectators whilst wearing skirt polyester.
- (d) RA Inf WO2 and SNCO, and authorised members of the Corps of Staff Cadets and OCDTs.

ADM

5-25

(e) Only worn by those qualified members, IAW [Annex 4O](#).

Figure 5-15: Dress Order No 2C 'Ceremonial Dress' (Other Ranks)



Figure 5-16: Dress Order No 2C 'Ceremonial Dress' (Non-Commissioned Officer)



Figure 5-17: Dress Order No 2C 'Ceremonial Dress' (Officer)



DRESS ORDER NO 2D ‘CEREMONIAL DRESS COLD WEATHER’

5.27 This order of dress may be worn by all ranks as spectators at ceremonial parades when, Dress Order No 1B ‘Ceremonial Service Dress’ has not been issued and the climate dictates. It consists of the following items of dress:

Table 5-8: Dress Order No 2D ‘Ceremonial Dress Cold Weather’

| Serial | Item of Dress | Remarks |
|--------|---|---|
| 1 | Australian Army Rising Sun Badge embroidered on khaki background | |
| 2 | Badge AIRN | If qualified |
| 3 | Badge commendation or soldiers medallion | If awarded |
| 4 | Badge ACB/ICB/MIB/RIB | If presented/awarded |
| 5 | Bandolier | Note (a) |
| 6 | Belt black and belt hooks | |
| 7 | Belt white | AFG, RMC, ADFA, RACMP units |
| 8 | Belt Sam Browne, shoulder strap and belt hooks | Note (b) |
| 9 | Boards shoulder khaki | Officer and OCDT/SCDT |
| 10 | Emblems of unit citation and/or awards | If awarded |
| 11 | Hat KFF with appropriate hat badge | Brim up |
| 12 | Lanyard and appropriate insignia shoulder | |
| 13 | Nameplate | |
| 14 | Necktie khaki polyester | |
| 15 | Orders, decorations and medals | If awarded |
| 16 | Black Court shoes or R.M. Williams elastic sided, black leather boots | Notes (c) and (d) |
| 17 | Rank insignia | Officer rank to be pinned to board shoulder khaki |
| 18 | Sash scarlet | Note (e) |
| 19 | Shirt polyester long sleeve | Note (f) |
| 20 | Skirt polyester | |
| 21 | Socks khaki | |
| 22 | Sword and accessories | Note (b) |
| 23 | Trade/skill qualification badge | Note (g) |
| 24 | Trousers polyester | |

Notes:

- (a) Worn by members posted to a RAAC unit when carrying Lances.
- (b) Officers and WO1. For Senior officers, IAW [Annex 5C](#).

- (c) The issued R.M. Williams elastic sided, black leather boots may be worn when with ceremonial orders of dress (on parade), General Duty Dress (polyesters), General Duty Service Dress and mess dress orders of dress.
- (d) R.M. Williams elastic sided, black leather boot are not to be worn by female spectators whilst wearing skirt polyester.
- (e) RA Inf WO2 and SNCO, and authorised members of the Corps of Staff Cadets and OCDTs.
- (f) Thermal underwear may be worn in cold weather.
- (g) Only worn by those qualified members, IAW [Annex 40](#).

Figure 5-18: Dress Order No 2D 'Ceremonial Dress Cold Weather' (Non-Commissioned Officer)



Figure 5-19: Dress Order No 2D 'Ceremonial Dress Cold Weather' (Officer)



DRESS ORDER NO 2E ‘GENERAL DUTY DRESS (POLYESTERS)’

5.28 This order of dress is the general duty dress for all rank appointments for whom polyester uniform is more appropriate due to the representational nature of the appointment or duty at the time. It consists of the following items of dress:

Table 5-9: Dress Order No 2E ‘General Duty Dress (polyesters)’

| Serial | Item of Dress | Remarks |
|--------|---|-----------------------|
| 1 | Australian Army Rising Sun Badge embroidered on khaki background | |
| 2 | Badge AIRN | If qualified |
| 3 | Badge commendation or soldiers medallion | If awarded |
| 4 | Badge ACB/ICB/MIB/RIB | If presented/awarded |
| 5 | Belt khaki 32 mm | |
| 6 | Belt Sam Browne, shoulder strap and belt hooks | Note (a)(g) |
| 7 | Beret Corps/Regiment/Unit with appropriate hat badge | Note (b) |
| 8 | Emblems of unit citation and/or awards | If awarded |
| 9 | Embroidered rank slides | Officer and OCDT/SCDT |
| 10 | Hat KFF with appropriate hat badge | Brim down |
| 11 | Lanyard and appropriate insignia shoulder | |
| 12 | Nameplate | |
| 13 | Black Court shoes or R.M. Williams elastic sided, black leather boots | Notes (c) and (d) |
| 14 | Rank insignia | |
| 15 | Ribbons of orders, decorations and medals | If awarded |
| 16 | Shirt short sleeve polyester | |
| 17 | Skirt polyester | |
| 18 | Socks khaki | |
| 19 | Trade/skill qualification badge | Note (e)(f) |
| 20 | Trousers polyester | |
| 21 | Dress General Duty Female | |

Notes:

- (a) ADJTs and RSMs are to wear the Sam Browne Belt, IAW [Chapter 3](#).
- (b) Berets are to be worn, IAW [Chapter 3](#).
- (c) The issued R.M. Williams Elastic sided black leather boots may be worn when with ceremonial orders of dress (on parade), General Duty Dress (polyesters), General Duty Service Dress and mess dress orders of dress.
- (d) When trousers are worn, women can either wear Court shoes or the issued R.M. Williams elastic sided, black leather boot. Boots are not worn with Skirt or General Duty Dress

ADM

5-32

- (e) Only worn by those qualified members, IAW [Annex 4O](#).
- (f) Not to be worn with Dress General Duty – Female
- (g) Not to be worn with Dress General Duty – Female

Figure 5-20: Dress Order No 2E 'General Duty Dress (polyesters)' (Other Ranks)



Figure 5-21: Dress Order No 2E 'General Duty Dress (polyesters)' (Non-Commissioned Officer)



Figure 5-22: Dress Order No 2E 'General Duty Dress (polyesters)' (Non-Commissioned Officer)



Figure 5-23: Dress Order No 2E 'General Duty Dress (polyesters)' (Officer)



Figure 5-24: Dress Order No 2E 'General Duty Dress (polyesters)' (Officer)



Figure 5-25: Dress Order No 2E 'General Duty Dress (polyesters)



DRESS ORDER NO 2F ‘GENERAL DUTY DRESS COLD WEATHER’

5.29 This order of dress is the cold weather general duty dress for all ranks, for when polyester uniform is more appropriate due to the representational nature of the appointment. This dress is the cold weather order of Dress Order No 2E–General Duty Dress (polyesters). This order of dress is to be worn at official mess functions if a Mess Dress has not been issued or is not entitled to be worn. It consists of the following items of dress:

Table 5–10: Dress Order No 2F ‘General Duty Dress Cold Weather’

| Serial | Item of Dress | Remarks |
|--------|---|--------------------------|
| 1 | Australian Army Rising Sun Badge embroidered on khaki background | |
| 2 | Badge AIRN | If qualified |
| 3 | Badge commendation or soldiers medallion | If awarded |
| 4 | Badge ACB/ICB/MIB/RIB | If presented/awarded |
| 5 | Belt khaki 32 mm | |
| 6 | Belt Sam Browne, shoulder strap and belt hooks | Note (a) |
| 7 | Beret Corps/Regiment/Unit with appropriate hat badge | Note (b) |
| 8 | Emblems of unit citation and/or awards | If awarded |
| 9 | Embroidered rank slides | Officer and OCDT/SCDT |
| 10 | Hat KFF with appropriate hat badge | Brim down |
| 11 | Lanyard and appropriate insignia shoulder | |
| 12 | Nameplate | |
| 13 | Necktie khaki polyester | |
| 14 | Black Court shoes or R.M. Williams elastic sided, black leather boots | Notes (c) and (d) |
| 15 | Ribbons of orders, decorations and medals | If awarded |
| 16 | Shirt long sleeve polyester | Note (e) |
| 17 | Skirt polyester | |
| 18 | Socks khaki | |
| 19 | Trade/skill qualification badge | Note (f) |
| 20 | Trousers polyester | |
| 21 | Garrison jacket | Khaki brown uniform |
| 22 | Utility Jacket | Khaki olive drab uniform |

Notes:

- (a) ADJTs and RSMs are to wear the Sam Browne Belt, IAW [Chapter 3](#).
- (b) Berets are to be worn, IAW [Chapter 3](#).

ADM

5-39

- (c) The issued R.M. Williams elastic sided, black leather boots may be worn when with ceremonial orders of dress (on parade), General Duty Dress (polyesters), General Duty Service Dress and mess dress orders of dress.
- (d) When trousers are worn, women can either wear Court shoes or the issued R.M. Williams elastic sided, black leather boot. Boots are not worn with skirt.
- (e) Thermal underwear may be worn in cold weather.
- (f) Only worn by those qualified members, IAW [Annex 4O](#).

Figure 5-26: Dress Order No 2F 'General Duty Dress Cold Weather' (Other Ranks)



Figure 5-27: Dress Order No 2F 'General Duty Dress Cold Weather' (Non-Commissioned Officer)



Figure 5-28: Dress Order No 2F 'General Duty Dress Cold Weather' (Non-Commissioned Officer)



Figure 5-29: Dress Order No 2F 'General Duty Dress Cold Weather' (Officer)



Figure 5-30: Dress Order No 2F 'General Duty Dress Cold Weather' (Officer)



DRESS ORDER NO 2G ‘GENERAL DUTY OFFICE DRESS’

5.30 Dress Order NO 2G this order of dress is the general duty dress for all rank appointments for whom polyester uniform is more appropriate in the **office environment**. It consists of the following items of dress: it is not to be worn when **representational appointments or ceremonial events**.

Table 5-11: Dress Order No 2G ‘General Duty Office Dress (polyesters)’

| Serial | Item of Dress | Remarks |
|--------|---|---|
| 1 | Australian Army Rising Sun Badge embroidered on khaki background | |
| 2 | Belt khaki 32 mm/Belt GDD Leather with Brushed Nickle Buckle | |
| 3 | Hat KFF with appropriate hat badge | When outside |
| 4 | Embroidered rank slides | Officer and OCDT/SCDT |
| 5 | Beret Corps/Regiment/Unit with appropriate hat badge | Note (a) |
| 6 | Gorget | Note (b) |
| 8 | Nameplate | |
| 7 | Black Court shoes or R.M. Williams elastic sided, black leather boots | |
| 8 | Rank insignia | |
| 9 | Trade/skill qualification badge | Note (c) |
| 10 | Shirt short sleeve polyester | Note (d) |
| 11 | Socks khaki | |
| 12 | Skirt polyester | Black court shoes |
| 13 | Trousers polyester | Black court shoes/R.M.Williams elastic sided black leather boots |
| 14 | General Duty Dress - Female | Black court shoes, Rank slides Officer and OCDT/SCDT WO, SNCO, JNCO |

Notes:

- (a) Berets are to be worn, IAW [Chapter 3](#).
- (b) For Senior officers, IAW [Annex 5C](#).
- (c) Only worn by those qualified members, IAW [Annex 40](#). Only worn on the Shirt polyester.
- (d) Long sleeve with necktie may be worn in colder climate as cold weather option.

Figure 5-31: Dress Order No 2G 'General Duty Office Dress'



DRESS ORDER NO 3A ‘CEREMONIAL SAFARI SUIT’

5.30 This order of dress is no longer an authorised order of dress in Australia. It may only be worn by officers posted to Embassy positions and on representational duties in tropical areas outside of Australia Note (a). There is no entitlement for an issue of this uniform and is purchased at the members’ expense. It consists of the following items of dress:

Table 5–12: Dress Order No 3A ‘Ceremonial Safari Suit’

| Serial | Item of Dress | Remarks |
|--------|--|--|
| 1 | Australian Army Rising Sun Badge embroidered on khaki background | |
| 2 | Badge AIRN | If qualified |
| 3 | Badge commendation or soldiers medallion | If awarded |
| 4 | Badge ACB/ICB/MIB/RIB | If presented/awarded |
| 5 | Belt khaki 32 mm/ Belt GDD Leather with Brushed Nickle Buckle | |
| 6 | Emblems of unit citation and/or awards | If awarded |
| 7 | Hat KFF with appropriate hat badge | Note (a) |
| 8 | Jacket Safari | Line 40 AND 30 Australian Army Buttons ^{Note (b)} |
| 9 | Trousers polyester | |
| 10 | Rank insignia | Officer rank to be pinned to epaulette |
| 11 | Lanyard and insignia shoulder AUSTRALIA | Note (c) |
| 12 | Nameplate | |
| 13 | R.M. Williams elastic sided, black leather boots | |
| 14 | Ribbons of orders, decorations and medals | If awarded ^{Note (d)} |
| 15 | Socks khaki | |
| 16 | Trade/skill qualification badge | Note (e) |

Notes:

- a. Brim worn up for ceremonial Parades and activities, Brim worn down when attending functions and events.
- b. For General Officers are to wear gold General Buttons, IAW [Annex 5C](#)
- c. For General and Senior Officers Gorget Patch is worn in place of lanyard, IAW [Annex 5C](#)

ADM

5-47

- d. Orders, decorations and medals are to be worn in lieu of the ribbon bar when attending ceremonial parades, activities, events or functions.
- e. Only worn by those qualified members, IAW [Annex 4O](#).
- f. The Aiguillette is to be worn by Senior officers, only when worn on ceremonial occasions, IAW [Chapter 3](#) and [Annex 5C](#).

Figure 5-32: Dress Order No 3A 'Ceremonial Safari Suit Ceremonial Order with HKFF Brim Up'



Figure 5-33: Dress Order No 3A 'Ceremonial Safari Suit in General Duty Order with HKFF Brim Down'



DRESS ORDER NO 4A 'GENERAL DUTY DRESS (AUSTRALIAN MULTI-CAM CAMOUFLAGE UNIFORM)'

5.31 This order of dress is mandated across Army as dress of the day and may be worn when travelling in public including domestic civil aircraft and in the barracks environment. It consists of the following items of dress:

Table 5–13: Dress Order No 4A ‘General Duty Dress (Australian Multi-cam Camouflage Uniform)’

| Serial | Item of Dress | Remarks |
|--------|--|----------------------------------|
| 1 | Australian Army Rising Sun Badge embroidered on AMCU background | |
| 2 | Boots combat | Note (a) |
| 3 | Beret Corps/Regiment/Unit with appropriate hat badge | Note (b) |
| 4 | AMCU General Purpose Jacket | AMCU rank slide |
| 5 | Hat KFF with UCP with appropriate hat badge | Brim down ^{Note (c)} |
| 6 | Shirt AMCU field | Notes (d) and (e) |
| 7 | Issued T-Shirt green, Army logo green T-shirt or purchased prescribed colour T-shirt | Note (f) |
| 8 | Name tag AMCU | |
| 9 | Rank insignia AMCU | |
| 10 | Sign ANF patch and USP/Trade qualification patch/Identification arm patch | High visibility only Note (g) |
| 11 | Socks khaki | |
| 12 | Trousers AMCU field | Note (h) and (i) |
| 13 | Wet weather ensemble | Optional |

Notes:

- (a) Boots Combat are to be worn, IAW [Chapter 3](#).
- (b) Berets are to be worn, IAW [Chapter 3](#).
- (c) Hat KFF is worn with puggaree, including approved UCP, IAW [Chapter 3](#), chin strap and Corps hat badge only. The brim is to be turned down, with the exception of recruits, as required, at training establishments.
- (d) Sleeves are to be worn down and buttoned and/or fastened with velcro. They are not to be cut off, rolled-up or folded.
- (e) The shirt is to be worn outside the trousers. If the shirt is required to be tucked in, a pistol belt is to be worn, with the exception of recruits at training establishments who may, as required by the CO, wear black belts. Black belts may be ordered for training.
- (f) T-shirt green, Army Logo green T-shirt or purchased prescribed coloured T-shirt must be worn if the AMCU shirt is removed. The T-shirt green, Army logo green T-shirt or purchased prescribed coloured T-shirt is to be tucked in at all times, IAW [Chapter 3](#).
- (g) The ANF patch and USP/trade qualification patch/identification arm patch is to be worn, IAW [Chapter 3](#). The Field Shoulder Patch (FSP) is not worn with this order of dress.
- (h) Trousers are bloused over boots.
- (i) As an alternative form of dress, Trouser AMCU Combat maybe worn with the Shirt AMCU Field.

Figure 5-34: Dress Order No 4A 'General Duty Dress (Australian Multi-cam Camouflage Uniform)'



Figure 5-35: Dress Order No 4A 'General Duty Dress (Australian Multi-cam Camouflage Uniform)'



DRESS ORDER NO 4B 'FIELD DRESS (AUSTRALIAN MULTI-CAM CAMOUFLAGE UNIFORM)'

5.32 This order of dress is worn by personnel engaged in field exercises, training activities or whilst on operations. For safety reasons, AMCU is not to be worn on activities such as firefighting where more visible and appropriate protective clothing is required. It consists of the following items of dress:

Table 5-14: Dress Order No 4B 'Field Dress (Australian Multi-cam Camouflage Uniform)'

| Serial | Item of Dress | Remarks |
|--------|--|---------------------------------|
| 1 | Australian Army Rising Sun Badge embroidered on AMCU background | |
| 2 | Boots combat | Note (a) |
| 3 | AMCU General Purpose Jacket | AMCU rank slide |
| 4 | Field hat/helmet | Note (b) |
| 5 | Shirt AMCU field | Notes (c) and (d) |
| 6 | Issued T-Shirt green, Army logo green T-shirt or purchased prescribed colour T-shirt | Note (e) |
| 7 | Load carrying equipment | |
| 8 | Name tag AMCU | |
| 9 | Rank insignia AMCU | |
| 10 | Sign ANF patch and FSP/Trade qualification patch/Identification arm patch | Low visibility only Note (f) |
| 11 | Socks khaki | |
| 12 | Trousers AMCU field | Note (g) and (h) |
| 13 | Wet weather ensemble | Optional |

Notes:

- (a) Boots Combat are to be worn, IAW [Chapter 3](#).
- (b) Shamags may be worn in hot dusty conditions with the approval of the CO. Shamags are not to be worn in the barracks environment.
- (c) Sleeves are to be worn down and buttoned and/or fastened with velcro. They are not to be cut off, rolled-up or folded.
- (d) The shirt is to be worn outside the trousers.
- (e) T-shirt green, Army Logo green T-shirt or purchased prescribed coloured T-shirt must be worn if the AMCU shirt is removed. The T-shirt green, Army logo green T-shirt or purchased prescribed coloured T-shirt is to be tucked in at all times, IAW [Chapter 3](#).
- (f) The ANF patch and FSP/trade qualification patch/ identification arm patch is to be worn, IAW [Chapter 3](#). The USP is not worn with this order of dress.
- (g) May be worn with or without a combat belt. Trousers are bloused over boots, it may be un-bloused when operational tasking or duty permits.
- (h) As an alternative form of dress, Trouser AMCU Combat maybe worn with the Shirt AMCU Field.

Figure 5-36: Dress Order No 4B 'Field Dress (Australian Multi-cam Camouflage Uniform)'



Figure 5-37: Dress Order No 4B 'Field Dress (Australian Multi-cam Camouflage Uniform)'



DRESS ORDER NO 4C 'COMBAT DRESS (AUSTRALIAN MULTI-CAM CAMOUFLAGE UNIFORM)'

5.33 This order of dress is worn by personnel when combat ensemble or body armour is being worn. This dress type is **only** to be used and worn when the user is wearing the combat ensemble or body armour IAW paragraphs 5.34 and 5.35. For safety reasons, AMCU is not to be worn on activities such as firefighting where more visible and appropriate protective clothing is required.

5.34 For cost reasons and UV protection the Shirt AMCU combat **is only** to be worn when the member is wearing body armour. The knit fabric used in the torso of the Combat Shirt does not provide adequate UV protection when worn as a single item. This risk is mitigated by the wearing of the body armour ensemble over the knitted area providing UV protection.

5.35 The Shirt AMCU combat **is not to be** worn:

- a. in the barracks environment as dress of the day
- b. during field exercises when body armour is not being worn
- c. on operations when body armour is not required
- d. during PT or Battle PT when body armour is not worn.

5.36 Combat Dress consists of the following items of dress:

Table 5–15: Dress Order No 4C ‘Combat Dress (Australian Multi-cam Camouflage Uniform)’

| Serial | Item of Dress | Remarks |
|--------|---|----------|
| 1 | Boots combat | Note (a) |
| 2 | Combat ensemble / body armour | |
| 3 | Field hat/helmet | |
| 4 | Knee / Elbow pads | Note (b) |
| 5 | Shirt AMCU combat | Note (c) |
| 6 | Issued T-Shirt green or purchased prescribed colour T-shirt | |
| 7 | Rank patch AMCU | Note (d) |
| 8 | Sign ANF patch low visibility | Note (e) |
| 9 | Socks khaki | |
| 10 | Trousers AMCU combat | Note (f) |

Notes:

- (a) Boots Combat are to be worn, IAW [Chapter 3](#).
- (b) May be worn dependant on the nature of the duties.
- (c) Embellished with rank patch and low visibility ANF.
- (d) Worn on right sleeve.
- (e) Worn on left sleeve.
- (f) May be worn with or without a combat belt. Trousers are bloused over boots, it may be un-bloused when operational tasking or duty permits. Combat trousers may be worn with Field or Barracks dress.

Figure 5-38: Dress Order No 4C 'Combat Dress (Australian Multi-cam Camouflage Uniform)'



Figure 5-39: Dress Order No 4C 'Combat Dress (Australian Multi-cam Camouflage Uniform)'



**DRESS ORDER NO 5A 'ARMOURED FIGHTING VEHICLE CREWMAN,
AUSTRALIAN MULTI-CAM CAMOUFLAGE UNIFORM'**

5.37 This order of dress is worn by AFV crewmen when operating AFVs (CRV, M113AS4 and M88A2) in barracks, on field exercises or training activities. When not operating AFVs, other issued orders of dress, as applicable; are to be worn. It consists of the following items of dress:

**Table 5-16: Dress Order No 5A 'Armoured Fighting Vehicle Crewman
(Australian Multi-cam Camouflage Uniform)'**

| Serial | Item of Dress | Remarks |
|--------|--|---|
| 1 | Boots combat | Note (a) |
| 2 | Field hat/Helmet crewman | |
| 3 | AMCU General Purpose Jacket | Optional and on order, and worn over AMCU |
| 4 | Shirt AMCU combat | |
| 5 | Issued T-Shirt green, Army logo green T-shirt or purchased prescribed colour T-shirt | Note (b) |
| 6 | Rank insignia AMCU | Note (c) |
| 7 | Sign ANF patch/Individual identification arm patch | Low visibility only Note (d) |
| 8 | Socks khaki | |
| 9 | Trousers AMCU combat | Note (e) |

Notes:

- (a) Boots Combat are to be worn, IAW [Chapter 3](#).
- (b) T-shirt green, Army Logo green T-shirt or purchased prescribed coloured T-shirt must be worn if the AMCU shirt is removed. The T-shirt green, Army logo green T-shirt or purchased prescribed coloured T-shirt is to be tucked in at all times, IAW [Chapter 3](#).
- (c) Worn on right sleeve.
- (d) The ANF patch/Individual identification arm patch is to be worn, IAW [Chapter 3](#). The USP is not worn with this order of dress.
- (e) May be worn with or without a combat belt.

Figure 5-40: Dress Order No 5A 'Combat Dress AFV Crewman (Australian Multi-cam Camouflage Uniform)'



DRESS ORDER NO 5B 'COMBAT DRESS FLAME RETARDANT TANK CREWMAN, AUSTRALIAN MULTI-CAM CAMOUFLAGE UNIFORM'

5.38 This order of dress is worn by AFV crewmen when operating AFVs (M1A1 ABRAMS MBT) in barracks, on field exercises, training activities or whilst on operations where the Soldier Combat Ensemble or body armour is required to be worn. It consists of the following items of dress:

Table 5-17: Dress Order No 5B 'Armoured Fighting Vehicle Crewman, Flame Retardant Combat Dress (Australian Multi-cam Camouflage Uniform)'

| Serial | Item of Dress | Remarks |
|--------|--|----------|
| 1 | Boots combat | Note (a) |
| 2 | Combat ensemble / body armour | |
| 3 | Helmet/helmet crewman/field hat | |
| 4 | Knee / Elbow pads | Note (b) |
| 5 | Shirt AMCU FR | Note (c) |
| 6 | Issued T-Shirt green, Army logo green T-shirt or purchased prescribed colour T-shirt | Note (d) |
| 7 | FR Combat Gloves | |
| 8 | FR Balaclava | Note (e) |
| 9 | Rank insignia AMCU | Note (f) |
| 10 | Sign ANF patch and FSP/Trade qualification patch/Identification arm patch | Note (g) |
| 11 | Socks khaki | |
| 12 | Trousers AMCU FR | Note (h) |
| 13 | Wet weather ensemble | Optional |

Notes:

- (a) Boots Combat are to be worn, IAW [Chapter 3](#).
- (b) To be worn dependant on the nature of the duties.
- (c) Embellished with rank patch and low visibility ANF.
- (d) 100% polyester sports shirts **are not to** be worn with AMCU FR. T-shirt green, Army Logo green T-shirt or purchased prescribed coloured T-shirt must be worn if the AMCU shirt is removed. The T-shirt green, Army logo green T-shirt or purchased prescribed coloured T-shirt is to be tucked in at all times, IAW [Chapter 3](#).
- (e) FR Balaclava currently issued in black or OD Green.
- (f) Worn on right sleeve.
- (g) Worn on left sleeve.
- (h) May be worn with or without a combat belt. The trousers AMCU FR are not bloused over the boot.

Figure 5-41: Dress Order No 5B 'Armoured Fighting Vehicle Crewman, Flame Retardant Combat Dress (Australian Multi-cam Camouflage Uniform)



DRESS ORDER NO 6A 'MESS DRESS'

5.39 This order of dress is normally worn by officers at mess and other formal occasions during winter. It may be worn at other times when the formality of the occasion demands or when ordered. Additional information to the wearing of all mess dress orders of dress is in [Annex 5O](#). It consists of the following items of dress:

Table 5-18: Dress Order No 6A 'Mess Dress'

| Serial | Item of Dress | Remarks |
|--------|---|--|
| 1 | Australian Army Rising Sun Badge embroidered on red background | |
| 2 | Badge commendation or soldiers medallion—miniature | If awarded |
| 3 | Badge ACB/ICB—miniature | If presented/awarded |
| 4 | Embroidered miniature gold bullion | If presented/awarded |
| 5 | Badge metal aircrew—miniature | If presented |
| 6 | Bow tie black | |
| 7 | Emblems of unit citation and/or awards—miniature | If awarded |
| 8 | Insignia shoulder, 'AUSTRALIA' | |
| 9 | Jacket mess with collar badges | Line 30 Australian Army Rising Sun buttons ^{Note (a)} |
| 10 | Orders, decorations and medals—miniature | If awarded |
| 11 | Patent leather black boots, Black shoes, black Court shoes or R.M. Williams Elastic sided black leather boots | Notes (b), (c) and (d) |
| 12 | Rank insignia | Officer rank to be pinned to epaulette |
| 13 | Shirt white Marcella front | |
| 14 | Skirt black | Optional for women Note (e) |
| 15 | Slacks black | Optional for women Notes (d) and (e) |
| 16 | Socks black | |
| 17 | Stockings/pantihose black | |
| 18 | Studs shirt | Note (f) |
| 19 | Trade/skill qualification badge | Note (g) |
| 20 | Trousers black | |
| 21 | Waistcoat Corps | Line 20 Australian Army Rising Sun buttons ^{Note (h)} |

Notes:

- (a) Senior officers, COL and above wear the Australian Army Rising Sun Badge (bullion) on the left shoulder sleeve of the jacket. Other officers wear the Australian Army Rising Sun Badge (embroidered on appropriate colour background) on the left shoulder sleeve. All members are to wear the Australian Army Rising Sun Badge and full size qualification badges (if qualified) on the jacket.
- (b) Black shoes are no longer an IFI item and have been removed from the Block scale. Black shoes may be purchased from the area clothing store until current stocks are exhausted. Black shoes are optional and may continue to be worn until they become unserviceable.
- (c) Patent leather black boots or the issued R.M. Williams Elastic sided black leather boots may be worn with Mess Dress orders of dress.
- (d) Women can wear Court shoes when the skirt, slacks or trousers are worn. When skirt is worn black leather court shoes are to be worn.
- (e) Women may purchase Slacks black as an optional item on repayment and may wear them in lieu of the Skirt black.
- (f) Shirt studs are to be plain gold or silver appropriate to Corps, IAW [Annex 5O](#).
- (g) Only worn by those qualified members, IAW [Annex 4O](#).
- (h) Watch/fob chains are not to be worn.

Figure 5-42: Dress Order No 6A 'Mess Dress'



Figure 5-43: Dress Order No 6A 'Mess Dress'



DRESS ORDER NO 6B ‘MESS DRESS WHITE JACKET’

5.40 This order of dress is worn at mess and other formal occasions by officers, (LT – LTCOL), WOs, SNCOs SCDTs, at RMC and OCDTs at ADFA, when the formality of the occasion demands, or when ordered. **This form of dress is to be worn by all officers (LT – LTCOL), when attending functions in the SGTs’ Mess Senior Officers, RSM-A and Tier –C RSM are to wear Dress Order NO 6C ‘SENIOR RANKS MESS DRESS’.** Additional information to the wearing of all mess dress orders of dress is in [Annex 5O](#). It consists of the following items of dress:

Table 5-19: Dress Order No 6B ‘Mess Dress White Jacket’

| Serial | Item of Dress | Remarks |
|--------|---|---|
| 1 | Australian Army Rising Sun Badge embroidered on white background | |
| 2 | Badge commendation or soldiers medallion–miniature | If awarded |
| 3 | Badge ACB/ICB–miniature | If presented/awarded |
| 4 | Embroidered miniature gold bullion | If presented/awarded |
| 5 | Badge metal aircrew–miniature | If presented |
| 6 | Bow tie black | |
| 7 | Cummerbund Corps or non-Corps | Note (a) |
| 8 | Emblems of unit citation and/or awards–miniature | If awarded |
| 9 | Insignia shoulder, ‘AUSTRALIA’ | |
| 10 | Jacket mess white with collar badges | Line 30 Australian Army Rising Sun buttons ^{Notes (b) and (c)} |
| 11 | Orders, decorations and medals–miniature | If awarded |
| 12 | Patent leather black boots, Black shoes, black Court shoes or R.M. Williams Elastic sided black leather boots | Notes (d) and (e) |
| 13 | Rank insignia | Officer rank to be pinned to epaulette |
| 14 | Sash scarlet | Note (f) |
| 15 | Shirt white plain front | |
| 16 | Skirt black | Optional for women Note (g) |
| 17 | Slacks black | Optional for women Notes (g) and (h) |
| 18 | Socks black | |
| 19 | Stockings/pantihose black | |
| 20 | Trade/skill qualification badge | Note (i) |
| 21 | Trousers black | |

Notes:

- (a) Corps colours are in [Annex 5O](#).
- (b) Officers, WOs and SNCOs wear the Australian Army Rising Sun Badge (gold embroidered on white background) on the upper left sleeve.
- (c) All members are to wear the Australian Army Rising Sun Badge and full size qualification badges (if qualified) on the jacket.
- (d) Black shoes are no longer an IFI item and have been removed from the Block scale. Black shoes may be purchased from the area clothing store until current stocks are exhausted. Black shoes are optional and may continue to be worn until they become unserviceable.
- (e) Patent leather black boots or the issued R.M. Williams Elastic sided black leather boots may be worn with Mess Dress orders of dress.
- (f) Worn under the jacket by RA Inf WO2 and SNCO, and authorised members of the Corps of Staff Cadets and OCDTs.
- (g) Women can wear Court shoes when the skirt, slacks or trousers are worn. When skirt is worn black leather court shoes are to be worn.
- (h) Women may purchase Slacks black as an optional item on repayment and may wear them in lieu of the Skirt black.
- (i) Only worn by those qualified members, IAW [Annex 4O](#).

Figure 5-44: Dress Order No 6B 'Mess Dress White Jacket' (Senior Non-Commissioned Officer)



Figure 5-45: Dress Order No 6B 'Mess Dress White Jacket' (Officer)



Figure 5-46: Dress Order No 6B 'Mess Dress White Jacket' (Officer)



DRESS ORDER NO 6C ‘SENIOR RANKS MESS DRESS’

5.41 This order of dress is worn by all Senior officers, COL and above, RSM–A and Tier C RSMs, at mess and other formal occasions. It may be worn at other times when the formality of the occasion demands or when ordered. Additional information to the wearing of all mess dress orders of dress is in [Annex 5O](#). It consists of the following items of dress:

Table 5–20: Dress Order No 6C ‘Senior Ranks Mess Dress’

| Serial | Item of Dress | Remarks |
|--------|---|---|
| 1 | Australian Army Rising Sun Badge embroidered on black background | |
| 2 | Aiguillette | Note (a) |
| 3 | Badge commendation or soldiers medallion–miniature | If awarded |
| 4 | Badge ACB/ICB–miniature | If presented/awarded |
| 5 | Embroidered miniature gold bullion | If presented/awarded |
| 6 | Badge metal aircrew–miniature | If presented |
| 7 | Bow tie black | |
| 8 | Chain jacket | Note (b) |
| 9 | Cummerbund Corps or non-Corps | Note (c) |
| 10 | Emblems of unit citation and/or awards–miniature | If awarded |
| 11 | Insignia shoulder, ‘AUSTRALIA’ | |
| 12 | Jacket red with collar badges | Line 30 Australian Army Rising Sun buttons ^{Notes (d) and (e)} |
| 13 | Orders, decorations and medals–miniature | If awarded |
| 14 | Patent leather black boots, Black shoes, black Court shoes or R.M. Williams Elastic sided black leather boots | Notes (f) and (g) |
| 15 | Rank insignia | Officer, RSM–A and WO1 rank to be pinned to shoulder board |
| 16 | Shirt white Marcella front | Note (h) |
| 17 | Shoulder boards black curved | |
| 18 | Skirt black with 4 cm red stripe | Optional for women ^{Note (i)} |
| 19 | Slacks black with 4 cm red stripe | Optional for women Notes (i) and (j) |
| 20 | Socks black | |
| 21 | Stockings/pantihose black | |
| 22 | Trade/skill qualification badge | Note (k) |
| 23 | Trousers black with 4 cm red stripe | |

Notes:

- (a) Worn by entitled members, IAW [Chapter 3](#).
- (b) Members are to wear either the silver or gold chain appropriate to Corps. MAJGEN and above wear gold General's buttons and gold chain, IAW [Annex 5O](#). RSM-A and Tier C RSMs wear the gold chain, IAW [Annex 5O](#).
- (c) Corps colours are in [Annex 5O](#).
- (d) Collar badges are only worn by Senior officers when attending as HOC or Corps Honorary appointment. RSM-A and Tier C RSMs wear the Australian Army Rising Sun collar badges.
- (e) All members are to wear the Australian Army Rising Sun Badge and full size qualification badges (if qualified) on the jacket.
- (f) Black shoes are no longer an IFI item and have been removed from the Block scale. Black shoes may be purchased from the area clothing store until current stocks are exhausted. Black shoes are optional and may continue to be worn until they become unserviceable.
- (g) Patent leather black boots or the issued R.M. Williams Elastic sided black leather boots may be worn with Mess Dress orders of dress.
- (h) Members are to wear either the silver or gold studs appropriate to Corps, IAW [Annex 5O](#).
- (i) Women can wear Court shoes when the skirt, slacks or trousers are worn. When skirt is worn black leather court shoes are to be worn.
- (j) Women may purchase Slacks black as an optional item on repayment and may wear them in lieu of the Skirt black.
- (k) Only worn by those qualified members, IAW [Annex 4O](#).

Figure 5-47: Dress Order No 6C 'Senior Ranks Mess Dress' (Officer)



Figure 5-48: Dress Order No 6C 'Senior Ranks Mess Dress' (Regimental Sergeant Major – Army and Tier C Regimental Sergeant Major)



DRESS ORDER NO 6D 'MESS DRESS ARMY'

5.42 This order of dress is worn at mess and other formal occasions by all officers, WOs and SNCOs from SGT to LTCOL, excluding RSM-A and Tier C RSMs, and SCDTs, at RMC and OCDTs at ADFA, when the formality of the occasion demands, or when ordered. Additional information to the wearing of all mess dress orders of dress is in [Annex 5O](#). It consists of the following items of dress:

Table 5-21: Dress Order No 6D 'Mess Dress Army'

| Serial | Item of Dress | Remarks |
|--------|---|--|
| 1 | Australian Army Rising Sun Badge embroidered on black background | |
| 2 | Aiguillette | Note (a) |
| 3 | Badge commendation or soldiers medallion—miniature | If awarded |
| 4 | Badge ACB/ICB—miniature | If presented/awarded |
| 5 | Embroidered miniature gold bullion | If presented/awarded |
| 6 | Badge metal aircrew—miniature | If presented |
| 7 | Bow tie black | |
| 8 | Chain jacket | Note (b) |
| 9 | Cummerbund Corps or non-Corps | Note (c) |
| 10 | Emblems of unit citation and/or awards—miniature | If awarded |
| 11 | Insignia shoulder, 'AUSTRALIA' | Note (d) |
| 12 | Jacket black with collar badges | Line 30 Australian Army Rising Sun buttons Note (e) |
| 13 | Orders, decorations and medals—miniature | If awarded |
| 14 | Patent leather black boots, Black shoes, black Court shoes or R.M. Williams Elastic sided black leather boots | Notes (f) and (g) |
| 15 | Rank insignia | Officer and WO1 rank to be pinned to shoulder board |
| 16 | Sash scarlet | Note (h) |
| 17 | Shirt white Marcella front | Note (i) |
| 18 | Shoulder boards black curved | WO and SNCO embroidered |
| 19 | Skirt black with 2 cm red stripe | Optional for women ^{Note (j)} |
| 20 | Slacks black with 2 cm red stripe | Optional for women Notes (j) and (k) |
| 21 | Socks black | |

| Serial | Item of Dress | Remarks |
|--------|-------------------------------------|----------|
| 22 | Stockings/pantihose black | |
| 23 | Trade/skill qualification badge | Note (l) |
| 24 | Trousers black with 4 cm red stripe | |

Notes:

- (a) Worn by entitled members, IAW [Chapter 3](#).
- (b) Members are to wear either the silver or gold chain appropriate to Corps, IAW [Annex 5O](#).
- (c) Corps colours are in [Annex 5O](#).
- (d) WO1 rank and above are to wear the curved metal 'AUSTRALIA' shoulder titles. WO2 rank and below are to wear the curved embroidered 'AUSTRALIA' shoulder titles.
- (e) All members are to wear the Australian Army Rising Sun Badge and full size qualification badges (if qualified) on the jacket.
- (f) Black shoes are no longer an IFI item and have been removed from the Block scale. Black shoes may be purchased from the area clothing store until current stocks are exhausted. Black shoes are optional and may continue to be worn until they become unserviceable.
- (g) Patent leather black boots or the issued R.M. Williams Elastic sided black leather boots may be worn with Mess Dress orders of dress.
- (h) Worn under the jacket by RA Inf WO2 and SNCO and authorised members of the Corps of Staff Cadets and OCDTs.
- (i) Members are to wear either the silver or gold studs appropriate to Corps, IAW [Annex 5O](#).
- (j) Women can wear Court shoes when the skirt, slacks or trousers are worn. When skirt is worn black leather court shoes are to be worn.
- (k) Women may purchase Slacks black as an optional item on repayment and may wear them in lieu of the Skirt black.
- (l) Only worn by those qualified members, IAW [Annex 4O](#).

Figure 5-49: Dress Order No 6D 'Mess Dress Army' (Senior Non-Commissioned Officer)



Figure 5-50: Dress Order No 6D 'Mess Dress Army' (Officer)



DRESS ORDER NO 7 ‘WORKING/PROTECTIVE DRESS’

5.43 Working/Protective Dress is to be worn where injury may be sustained by personnel or when engaged in activities which may cause damage to other orders of dress. **This dress is not worn in public.** Working/Protective Dress is worn by ORs but may be worn by officers when ordered by a CO.

5.44 Safety equipment, such as safety footwear, goggles, gloves etc which is required for particular tasks are specified in safety regulations or unit standing orders and the scale of issue is indicated in the relevant block scales. It consists of the following items of dress:

Table 5-22: Dress Order No 7 ‘Working/Protective Dress’

| Serial | Item of Dress | Remarks |
|--------|--|-----------------------------|
| 1 | Belt khaki 32 mm | |
| 2 | Beret Corps/Regiment/Unit with appropriate hat badge | Note (a) |
| 3 | Boots combat/Safety boots | Note (b) |
| 4 | AMCU General Purpose Jacket | |
| 5 | Coveralls khaki drill | Notes (c), (d) and (e) |
| 6 | Hat KFF/Field hat/Protective Headdress with appropriate hat badge | Note (f) |
| 7 | Issued T-Shirt green, Army logo green T-shirt or purchased prescribed colour T-shirt | Note (g) |
| 8 | Jacket khaki drill | Notes (c), (d), (e) and (h) |
| 9 | Name tag | Note (e) |
| 10 | Rank insignia | Note (e) |
| 11 | Shirt khaki drill | Notes (c), (d) and (e) |
| 12 | Shorts khaki drill | Notes (c) and (d) |
| 13 | Socks khaki | Note (i) |
| 14 | Trousers khaki drill | Notes (c) and (d) |

Notes:

- (a) Berets are to be worn, IAW [Chapter 3](#).
- (b) When boots combat are worn, trousers are to be bloused.
- (c) Khaki drill garments are specified but other colours, khaki through green, may be worn if supplied/issued. Style and colour of all such garments within a unit is to be uniform. Garments for ‘specified safety requirements’ the appropriate colours are to be worn.
- (d) Items supplied under unit Direct Unit Funding arrangements.
- (e) APCU insignia rank or a form a backing of the appropriate colour according to garment is to be sewn to the shirt sleeves. APCU name tag or a form a backing of the appropriate colour according to garment is to be sewn above the right breast pocket of the shirt. The Australian Army Rising Sun Badge is not worn on Protective Dress garments.
- (f) Protective headdress is to be worn by plant operators when ordered.

- (g) T-shirt green, Army Logo green T-shirt or purchased prescribed coloured T-shirt must be worn if the AMCU or PD shirt is removed. The T-shirt green, Army logo green T-shirt or purchased prescribed coloured T-shirt is to be tucked in at all times, IAW [Chapter 3](#).
- (h) Jacket khaki drill is specified but a 'bomber style' jacket may be worn. The jacket may be worn over a shirt in appropriate weather conditions.
- (i) Socks are to be rolled down over the tops of boots when shorts are worn.

Figure 5-51: Dress Order No 7 'Working/Protective Dress (Shorts)'



Figure 5-14: Dress Order No 7 'Working/Protective Dress (Trousers)'



Figure 5-53: Dress Order No 7 'Working/Protective Dress (Trousers with Long Sleeve Shirt)'



Figure 5-54: Dress Order No 7 'Working/Protective Dress (Trousers with Jacket Khaki Drill)'



DRESS ORDER NO 8 ‘MATERNITY DRESS’

5.45 This order of dress is worn as a general duty dress by members who have been certified for maternity benefits from the time of that certification. It consists of the following items of dress:

Table 5-23: Dress Order No 8 ‘Maternity Dress’

| Serial | Item of Dress | Remarks |
|--------|---|---|
| 1 | Australian Army Rising Sun Badge embroidered on khaki background | |
| 2 | Badge commendation or soldiers medallion | If awarded but not worn with cardigan |
| 3 | Badge ACB/ICB/MIB/RIB | If presented/awarded but not worn with cardigan |
| 4 | Belt khaki 32 mm | Optional |
| 5 | Beret Corps/Regiment/Unit with appropriate hat badge | Note (a) |
| 6 | Emblems of unit citation and/or awards | If awarded but not worn with cardigan |
| 7 | Embroidered rank slides | Officer and OCDT/SCDT |
| 8 | Hat KFF with appropriate hat badge | Brim down |
| 9 | Lanyard and appropriate insignia shoulder | Note (b) |
| 10 | Maternity shirt, short sleeve or long sleeve without breast pockets | Notes (c), (d) and (e) |
| 11 | Maternity shirt, short sleeve or long sleeve with breast pockets and fully buttoned | Notes (c), (d), (e) and (f) |
| 12 | Maternity cardigan | Note (g) |
| 13 | Maternity Skirt | Optional |
| 14 | Maternity Slacks | Optional |
| 15 | Nameplate | |
| 16 | Pantihose (maternity) or footlets | |
| 17 | Rank insignia | |
| 18 | Ribbons of orders, decorations and medals | If awarded but not worn with cardigan |
| 19 | Shoes black, black Court shoes or black maternity footwear | Note (h) |
| 20 | Socks khaki | |
| 21 | Trade/skill qualification badge | Note (i) |

Notes:

(a) Berets are to be worn, IAW [Chapter 3](#).

- (b) The lanyard is not to be worn on the Maternity Dress shirt that is issued without breast pockets, IAW Figure 5–52.
- (c) The Maternity Dress Shirt that is issued without breast pockets may be worn in lieu of the Maternity Dress Shirt that is issued with breast pockets, until current stock holdings are exhausted.
- (d) The embellishments are positioned on the maternity shirt in the same manner as the polyester short sleeve shirt.
- (e) The AIRN Badge is not worn with this order of dress.
- (f) The lanyard is to be worn on the Maternity Dress shirt that is issued with breast pockets, IAW Figure 5–53.
- (g) The cardigan may be worn unbuttoned if necessary. The cardigan is embellished in the same manner as the sweater khaki lightweight.
- (h) Black maternity footwear is non-issue Black shoes similar to Black Shoes and may be ‘slip-on’ or ‘lace-up’ by design. Those shoes are to have an enclosed heel and toe, and is purchased at the members’ expense.
- (i) Only worn by those qualified members, IAW [Annex 4O](#).

Figure 5–55: Dress Order No 8 ‘Maternity Dress Shirt without breast pockets’

TBA

Figure 5–56: Dress Order No 8 ‘Maternity Dress Shirt with breast pockets’

TBA

Figure 5–57: Dress Order No 4A ‘Maternity Dress (Australian Multi-cam Camouflage Uniform)’

TBA

DRESS ORDER NO 9 ‘AIRCREW FLAME RETARDANT FLYING DRESS’

5.46 This order of dress is worn by all aircrew members, aircraft maintenance personnel and aircraft support ground crew involved in flying duties, rearm/refuel duties or operations and emergency response service members, when required. When not engaged on flying or flying related duties other issued orders of dress are to be worn. It consists of the following items of dress:

Table 5–24: Dress Order No 9 ‘Aircrew Flame Retardant Flying Dress’

| Serial | Item of Dress | Remarks |
|--------|-------------------------------|------------------------------|
| 1 | Field hat | Worn on Tarmac/flying duties |
| 2 | Boots combat or safety boots | Note (a) |
| 3 | Socks khaki | |
| 4 | Trousers AMCU Flame Retardant | Note (b) |
| 5 | Shirt AMCU Flame Retardant | Note (c) |

| | | |
|---|--|----------|
| 6 | Issued T-Shirt green, Army logo green T-shirt or purchased prescribed colour T-shirt | Note (d) |
| 6 | Rank insignia AMCU | Note (e) |
| 7 | Sign ANF patch | Note (f) |
| 8 | Jacket, Cold Weather and Over-trousers Cold Weather | |
| 9 | Belt flyers / Belt Combat | Note (g) |

- (a) Aircrew to wear Combat issued Terra Boots version 2 or 4 only, IAW [Standing Instruction \(Aviation\) Operational 6-103—Personnel Protective Equipment](#)²². Ground crew are to wear safety boots, IAW [DEF\(AUST\)5695B—Petroleum Oils and Lubricants Manual](#)²³.
- (b) The trousers AMCU Flame Retardant are not bloused over the boot.
- (c) Embellished with rank and ANF patch is to be worn, IAW Chapter 3. Low Vis patch is to be worn when participating in field related training activities or during field exercises. The USP is not worn with this order of dress. 100% polyester sports shirts are not to be worn with AMCU Flame Retardant.
- (d) T-shirt green, Army Logo green T-shirt or purchased prescribed coloured T-shirt must be worn if the AMCU shirt is removed. The T-shirt green, Army logo green T-shirt or purchased prescribed coloured T-shirt is to be tucked in at all times, IAW Chapter 3.
- (e) Worn on right sleeve.
- (f) Worn on left sleeve.
- (g) Optional. If worn, PPE may be secured to the belt by a looped belt clip or similar.

²² http://intranet.defence.gov.au/home/documents/data/ARMYPUBS/SI/OPS/6_103.pdf

²³ <https://objective/id:AH4891202>

Figure 5-58: Dress Order No 9 'Aircrew Flame Retardant Flying Dress with Field Hat'



Annexes:

- 5A [Orders of Dress worn on particular occasions](#)
- 5B [Special order of dress for special appointments/selected personnel](#)
- 5C [Senior officer dress](#)
- 5D [Band ceremonial dress](#)
- 5E [Scottish dress](#)
- 5F [Chaplain dress](#)
- 5G [Army emergency response dress](#)
- 5H [Military equestrian dress](#)
- 5I [Australian Defence Force Academy Dress](#)
- 5J [Royal Military College—Duntroon Dress](#)
- 5K [Physical Training Instructor Dress](#)
- 5L [Medical, Dental and Nursing Working Dress](#)

OFFICIAL

ADM

5-88

5M [Military Police Dress](#)

5N [Catering trade dress](#)

5O [Mess Dress](#)

5P [Tri-Service equivalencies Orders of Dress](#)

AL5

OFFICIAL

ORDERS OF DRESS WORN ON PARTICULAR OCCASIONS

Table 5A–1: Orders of Dress worn on particular occasions

| Serial (a) | Occasion (b) | Capacity of participant (c) | Orders of Dress (d) | Remarks (e) |
|---------------|----------------------------|--|---|--|
| 1 | ANZAC Day | Troops on parade | Ceremonial parade orders of dress, ie Dress Orders No 1A, 2A and 2B ^{Note (a)} Dress Orders No SD1A, SD2A and SD2B less nameplate | NOK medals are not to be worn with uniform No berets to be worn When wearing Scottish Dress, the Bonnet Glengarry is only to be worn |
| | | Invited guests | Ceremonial orders of dress, ie Dress Orders No 1B, 2C, 2D and 3A ^{Note (b)} | No berets to be worn |
| | | Military spectators and marchers other than troops on parade | Civilian dress, ie Coat and tie with medals, Army Combat Badge (ACB)/ Infantry Combat Badge (ICB) and full size unit citation(s) and/or awards | NOK medals may be worn on the right breast No berets to be worn |
| 2 | Academic Graduation | Recipients and invited guests | Ceremonial orders of dress, ie Dress Order No 1B, 2C, 2D and 3A ^{Note (b)} | Eligible personnel may wear Academic Dress over uniform Recipients of Degrees etc or members of Academic staff may wear academic headdress Military guests and spectators are to wear military headdress |

| Serial (a) | Occasion (b) | Capacity of participant (c) | Orders of Dress (d) | Remarks (e) |
|---------------|--------------------------------------|---|--|--|
| 3 | Service Ball | Officers, Warrant Officers (WO) and Senior Non-Commissioned Officers (SNCO) | Mess Dress orders of dress, ie Dress Orders No 6A, 6B, 6C and 6D, as appropriate | Dress Orders No 6A and 6B are not to be worn after 31 December 2021 Dress Orders No 6C and 6D are to be worn from 01 January 2022 |
| | | ORs | Ceremonial orders of dress, ie Dress Orders No 1B, 2C and 2D | |
| | Civilian Ball | All ranks | Civilian dress, ie Dinner suit with miniature medals, miniature ACB/ICB and miniature unit citation(s) and/or awards Mess Dress orders of dress, ie Dress Orders No 6A, 6B, 6C and 6D, as appropriate in accordance with (IAW) the invitation General duty orders of dress, ie Dress Orders No 2E and 2F | Dress Orders No 6A and 6B are not to be worn after 31 December 2021 Dress Orders No 6C and 6D are to be worn from 01 January 2022 |
| 4 | Calling other than Vice-Regal | Nil | General duty orders of dress, ie Dress Orders No 1C, 2E, 2F and 3A Note (b) | See also Serial 21 'Vice-Regal Occasions' |

| Serial (a) | Occasion (b) | Capacity of participant (c) | Orders of Dress (d) | Remarks (e) |
|---------------|---|---|---|---|
| 5 | Ceremonial Parade including: Guard of Honour Trooping the Colour | Troops on parade and other participants | Ceremonial parade orders of dress, ie Dress Orders No 1A, 2A, 2B, 5A, SA1 and SO1 ^{Notes (a) and (c)} | <p>Dress Order No SA1–Patrol Blue White Jacket and Dress Order No SO1–Patrol Blue White Jacket Senior Officer is worn at ceremonial parades by entitled members only</p> <p>Dress Order No SA1–Patrol Blue White Jacket and Dress Order No SO1–Patrol Blue White Jacket Senior Officer is only worn by those members when those orders of dress are worn by troops on parade.</p> <p>Berets are not to be worn.</p> |
| | | Reviewing officer | Ceremonial parade orders of dress, ie Dress Orders No 1A, 2A, 2D, 3A, SA1 and SO1 ^{Notes (b), (c) and (d)} | Berets are not to be worn. |
| | | Invited guests and spectators | Ceremonial orders of dress, ie Dress Orders No 1B, 2C, 2D, 3A, SA1 and SO1 ^{Note (c)} | Berets are not to be worn. |

| Serial (a) | Occasion (b) | Capacity of participant (c) | Orders of Dress (d) | Remarks (e) |
|---------------|--|--|---|--|
| 6 | Church Service | All personnel other than members participating in related ceremonial procedures, ie the Colour Party | General duty orders of dress, ie Dress Orders No 1C, 2E, 2F and 4A Ceremonial orders of dress, ie Dress Orders No 1B, 2C, 2D and 3A <small>Note (b)</small> | A church service or parade is to be designated by the unit The order of dress is to be designated by the Commanding Officer (CO), appropriate to the nature of the service or parade |
| 7 | Court Martial | Personnel involved in court proceedings | Ceremonial orders of dress, ie Dress Orders No 1B, 2C, 2D and 3A <small>Note (b)</small> | |
| | | Spectators | General duty orders of dress, ie Dress Orders No. 1C, 2E and 2F | |
| 8 | Dining in a Service Mess – Formal | Officers, WOs and SNCOs | Mess Dress orders of dress, ie Dress Orders No 6A, 6B, 6C and 6D, as appropriate | Dress Order No 6B is to be worn by all officers when attending functions in the Sergeants' Mess Dress Orders No. 6A and 6B are not to be worn after 31 December 2021 Dress Orders No 6C and 6D are to be worn from 01 January 2022 |
| | | ORs | General duty orders of dress, ie Dress Orders No 1C, 2E, 2F | |
| | Dining in a Service Mess – Informal | All personnel | Civilian dress, ie Neat civilian attire General duty orders of dress, ie Dress Orders No 1C, 2E, 2F, 3A and 4A <small>Note (b)</small> | |

| Serial (a) | Occasion (b) | Capacity of participant (c) | Orders of Dress (d) | Remarks (e) |
|---------------|---|-----------------------------------|---|--|
| 9 | Diplomatic Occasion – Formal Dinner | Invited guests | Mess Dress orders of dress, ie Dress Orders No 6A, 6B, 6C and 6D, as appropriate Dress Order No SA1– Patrol Blue White Jacket or Dress Order No SO1–Patrol Blue White Jacket Senior Officer, or as indicated on invitation ^{Note (c)} | Dress Orders No 6A and 6B are not to be worn after 31 December 2021 Dress Orders No 6C and 6D are to be worn from 01 January 2022 |
| | Diplomatic Occasion – Informal Dinner | Invited guests | Lounge Suit or as indicated on invitation | Medals, ACB/ICB and unit citation and/or awards may be worn, if indicated on invitation |
| | Diplomatic Occasion – National Day or Armed Forces Day Reception | Invited guests | Ceremonial orders of dress, ie Dress Order No 1C, or as indicated on invitation | No berets to be worn |
| | Diplomatic Occasion – Other Reception | Invited guests | Civilian dress, ie Lounge Suit | Medals, ACB/ICB and unit citation and/or awards may be worn, if indicated on invitation |
| | Diplomatic Occasion – Other Occasion | Invited guests | As indicated on invitation | |

| Serial (a) | Occasion (b) | Capacity of participant (c) | Orders of Dress (d) | Remarks (e) |
|---------------|---------------------------------|-----------------------------------|---|--|
| 10 | Service/military funeral | Funeral service participants | Ceremonial parade orders of dress, ie Dress Orders No 1A, 2A, 2B and 3A Notes (a) and (b) | |
| | | Official Mourner and mourners | Ceremonial orders of dress, ie Dress Orders No 1B, 2C, 2D and 3A Note (b) | |
| | Civilian funeral | All personnel | Civilian dress, ie Coat and tie with medals, ACB/ICB and full size unit citation(s) and/or awards Ceremonial orders of dress, ie Dress Orders No 1B, 2C, 2D and 3A Note (b) | Approval to wear uniform is required from the members' CO |
| 11 | House Guard | All personnel | Ceremonial parade orders of dress, ie Dress Orders No 1A, 2A and 2B Note (a) | |
| 12 | Investiture | Recipients | Ceremonial parade orders of dress, ie Dress orders No 1B and 2D | Less sword and accessories Recipients are to wear Ribbon bar only when wearing uniform No berets to be worn |
| | | Invited guests and spectators | Ceremonial parade orders of dress, ie Dress Orders No 1B, 2C and 2D Civilian dress, ie Lounge Suit | Less sword and accessories Invited guests and spectators in uniform are to wear medals No berets to be worn |

| Serial (a) | Occasion (b) | Capacity of participant (c) | Orders of Dress (d) | Remarks (e) |
|---------------|---|---|--|--|
| 13 | Memorial Service – Outdoor | Troops on parade and other participants | Ceremonial parade orders of dress, ie Dress Orders No 1A, 2A and 2B ^{Note (a)} | |
| | | Invited guests and spectators | Ceremonial orders of dress, ie Dress Orders No 1B, 2C, 2D, 3A, SA1 and SO1 ^{Notes (b), (c) and (d)} | |
| | Memorial Service – Indoor | Invited guests and spectators | Ceremonial orders of dress, ie Dress Orders No 1B, 2C, 2D, 3A, SA1 and SO1 ^{Notes (b), (c) and (d)} | |
| 14 | Notification Team | CO/Padre/ Regimental Sergeant Major | General duty orders of dress, ie Dress Order No 4A | |
| | | Official on-call notification team | General duty orders of dress, ie Dress Order No 1C, 2E, 2F and 3A ^{Note (b)} | |
| 15 | Official function – State occasion, night-time | Invited guests | Mess Dress orders of dress, ie Dress Orders No 6A, 6B, 6C and 6D, as appropriate Dress Order No SA1–Patrol Blue White Jacket, or Dress Order No SO1–Patrol Blue White Jacket Senior Officer as indicated on invitation ^{Note (c)} | Dress Orders No 6A and 6B are not to be worn after 31 December 2021 Dress Orders No 6C and 6D are to be worn from 01 January 2022 |
| | Official function – State occasion, day-time | Invited guests | Ceremonial orders of dress, ie Dress Orders No 1B, 2C, 2D, 3A, SA1 and SO1 ^{Notes (b), (c) and (d)} | |
| | Official function – Other occasion | Invited guests | General duty orders of dress, ie Dress Order No 1C, 2E, 2F and 3A ^{Note (b)} | |

| Serial (a) | Occasion (b) | Capacity of participant (c) | Orders of Dress (d) | Remarks (e) |
|---------------|--|---|---|--|
| 16 | Remembrance Day | Troops on parade | Ceremonial parade orders of dress, ie Dress Orders No 1A, 2A and 2B Dress Orders No SD1A, SD2A and SD2B less nameplate | No berets to be worn When wearing Scottish Dress, the Bonnet Glengarry is only to be worn |
| | | Invited guests and spectators | Ceremonial orders of dress, ie Dress Orders No 1B, 2C, 2D and 3A <small>Note (b)</small> | No berets to be worn |
| | | Military spectators | Ceremonial orders of dress, ie Dress Orders No 1B, 2C, 2D and 3A <small>Note (b)</small> | No berets to be worn |
| 17 | Service function attended by the public | All personnel | General duty orders of dress, ie Dress Order No 1C, 2E, 2F, 3A and 4A <small>Note (b)</small> | No berets to be worn |
| 18 | Travelling on civilian aircraft on duty within Australia | All personnel | General duty orders of dress, ie Dress Order No 1C, 2E, 2F and 4A Civilian dress, ie ORs–Neat civilian attire, IAW Chapter 2 | |
| 19 | Travelling on civilian aircraft on duty outside Australia | All personnel | Civilian dress, ie Neat civilian attire | |
| 20 | United Nations Day, 24 October | Former members of the UN deployments attending commemorative ceremonies | Ceremonial orders of dress, ie Dress Orders No 1B, 2C, 2D and 3A <small>Note (b)</small> | UN blue beret may be worn with uniform on this day only |

| Serial (a) | Occasion (b) | Capacity of participant (c) | Orders of Dress (d) | Remarks (e) |
|---------------|--|-----------------------------------|--|--|
| 21 | Vice-Regal Occasion – Calling | As appropriate | Ceremonial orders of dress, ie Dress Orders No 1B, 2C, 2D and 3A <small>Note (b)</small> | |
| | Vice-Regal Occasion – Day function including garden party | Invited guests | General duty orders of dress, ie Dress Order No 1C, 2E, 2F, 3A and 4A <small>Note (b)</small> | |
| | Vice-Regal Occasion – Evening/night function | Invited guests | Mess Dress orders of dress, ie Dress Orders No 6A, 6B, 6C and 6D, as appropriate Dress Order No SA1– Patrol Blue White Jacket, or Dress Order No SO1–Patrol Blue White Jacket Senior Officer as indicated on invitation <small>Note (c)</small> | Dress Orders No 6A and 6B are not to be worn after 31 December 2021 Dress Orders No 6C and 6D are to be worn from 01 January 2022 |
| 22 | Walking outside when in contact with the public | All personnel | General duty orders of dress, ie Dress Order No 4A | Dress of the Day |
| | | All personnel | General duty orders of dress, ie Dress Order No 2E and 3A <small>Note (b)</small> | Attending meetings with business, government or foreign representatives outside of the unit or office |

| Serial (a) | Occasion (b) | Capacity of participant (c) | Orders of Dress (d) | Remarks (e) |
|---------------|--|-----------------------------------|---|---|
| 23 | Wedding— Military, when approval has been given | Official party | Ceremonial orders of dress, ie Dress Orders No 1B, 2C, 2D, 3A, SA1 and SO1 <small>Notes (b) and (c)</small> Mess Dress orders of dress, ie Dress Orders No 6A, 6B, 6C and 6D, as appropriate | While there is a requirement to seek approval for a military wedding the choice to wear uniform rests with the individual Dress Orders No 6A and 6B are not to be worn after 31 December 2021 Dress Orders No 6C and 6D are to be worn from 01 January 2022 |
| | | Service guests | Civilian dress or as for the official party | |

Notes:

- (a) Unless being received on parade, swords are not worn with ceremonial orders of dress other than Dress Order No SO2 'Ceremonial Service Dress General Officer'.
- (b) This order of dress is only to be worn by officers posted to Embassy positions and on representational duties in tropical areas outside of Australia.
- (c) Patrol Blue White Jacket and Patrol Blue White Jacket Senior Officer is worn only by those personnel authorised to do so, IAW [Annex 5B](#), [Annex 5C](#) and [Chapter 1](#).
- (d) Reviewing officers, invited guests and spectators wear the order of ceremonial dress equivalent to the order of ceremonial parade dress worn by personnel on parade.

SPECIAL ORDER OF DRESS FOR SPECIAL APPOINTMENTS/SELECTED PERSONNEL

ORDERS OF DRESS

General duty and ceremonial dress

1. The orders for General Duty and Ceremonial Dress worn by those special appointments and selected personnel in [Chapter 1](#) and [Chapter 5](#).

Patrol Blue orders of dress

2. Patrol Blue orders of dress are only worn by those selected personnel in [Chapter 1](#).

Mess Dress

3. The orders for Mess Dress, Mess Dress White Jacket, Senior Ranks Mess Dress and Mess Dress Army are in [Chapter 5](#) and [Annex 5O](#).

AIDE-DE-CAMP OFFICERS

4. Appointed Aides-de-Camp (ADCs) are to wear the same order of dress as the officer to which they represent. Unless otherwise requested or stated in an invitation to a ceremonial parade, the General or Senior officer and his/hers ADC will wear Ceremonial Parade Service Dress with aiguillette (in accordance with (IAW) [Chapter 3](#)), nameplate (IAW [Chapter 3](#)), and sword with accessories, if the sword is required to be worn on parade.

EQUERRY OFFICERS

5. Appointed Equerries to HRH or Extra Equerries to other members of the Royal Family are to wear at all times, regardless of season, Ceremonial Parade Service Dress with aiguillette (IAW [Chapter 3](#)), nameplate (IAW [Chapter 3](#)), and sword with accessories, if the sword is required to be worn on parade.

6. Appointed ADCs and Equerries are entitled to an ADC allowance, in order to be reimbursed for the maintenance and/or cost of hire of clothing, to meet the requirements of the member's duties, IAW the provisions of [Pay and Conditions Manual](#)²⁴.

²⁴ <http://www.defence.gov.au/PayAndConditions/ADF/Chapter-1/default.asp>

SWORDS AND OTHER CEREMONIAL ACCOUTREMENTS

7. Swords, accessories and other ceremonial accoutrements worn by officers holding special appointments and selected personnel are listed below:
 - a. sword with steel scabbard
 - b. waist sash crimson silk, 7 cm wide, with two tassels
 - c. two red leather gold embroidered sword slings, 2.5 cm wide, the front sling is 51 cm long and the rear sling 89 cm
 - d. gold embroidered crimson sword knot with gold acorn
 - e. shoulder cords
 - f. waist belt with shoulder suspender for use with ceremonial slung sword
 - g. aiguillette for those entitled personnel, IAW [Chapter 3](#).
8. The method of wearing items of dress and assembling and wearing sword equipment is in [Chapter 3](#).

SPECIAL ORDERS OF DRESS

9. The special orders of dress worn by special appointments are in Table 5B–1:

Table 5B–1: Special orders of dress worn by special appointments

| Dress Number | Dress Order Title | Table |
|--------------|--------------------------|-------|
| SA1 | Patrol Blue White Jacket | 5B–2 |
| SA2 | Patrol Blue Jacket | 5B–3 |

DRESS ORDER NO SA1 ‘PATROL BLUE WHITE JACKET’

10. This order of dress is a ceremonial uniform which may be worn by those personnel authorised by Block Scale 3002/24, whilst employed in the position for which the uniform was issued. This order is also worn as a parade dress by entitled personnel in [Chapter 1](#).
11. It consists of the following items of dress:

Table 5B–2: Dress Order No SA1 ‘Patrol Blue White Jacket’

| Serial | Items of Dress | Remarks |
|--------|---|--------------|
| 1 | Aiguillette | Note (a) |
| 2 | Australian Army Rising Sun Badge embroidered Gold and Red on white background | |
| 3 | Badge AIRN | If qualified |
| 4 | Badge commendation or soldiers medallion | If awarded |

| Serial | Items of Dress | Remarks |
|--------|--|--|
| 5 | Badge ACB/ICB/MIB/RIB | If presented/awarded |
| 6 | Belt hooks | Note (b) |
| 7 | Belt web white/airmen's with Rising Sun Badge | Note (c) |
| 8 | Blue Service cap | Line 20 Australian Army Rising Sun buttons Note (d) |
| 9 | Collar badges | |
| 10 | Emblems of unit citation and/or awards | If awarded |
| 11 | Gloves white cotton | Note (c) |
| 12 | Gloves white kid leather | Note (e) |
| 13 | Gorget patches | For COL and above. Line 20 Australian Army Rising Sun buttons Note (d) |
| 14 | Insignia shoulder, 'AUSTRALIA' | |
| 15 | Nameplate | Not to be worn on parade ^{Note (f)} |
| 16 | Patent leather black boots or R.M. Williams elastic sided, black leather boots | Note (g) |
| 17 | Patrol Blue White Jacket | Line 40 and line 30 Australian Army Rising Sun buttons ^{Note (d)} |
| 18 | Orders, decorations and medals | If awarded |
| 19 | Rank insignia | Officer rank to be pinned to shoulder cords |
| 20 | Sash scarlet | Note (h) |
| 21 | Shoulder board black with scarlet bordering | WO and SNCO only |
| 22 | Shoulder cords | For officers |
| 23 | Slacks blue | |
| 24 | Socks black | |
| 25 | Sword and sword accessories | Notes (i) and (j) |
| 26 | Trade/skill qualification badge | Note (k) |
| 27 | Trousers blue | |
| 28 | Waist sash | Note (l) |

Notes:

- (a) Worn by those entitled officers in [Chapter 3](#).
- (b) Two brass belt hooks are used to support the Belt web white/airmen and are positioned to the side of the body when wearing the Belt.

ADM

5B-4

- (c) Worn by Colour/Flag Party and members of the AFG, when ordered.
- (d) MAJGEN above are to wear General's buttons.
- (e) Worn by MAJGEN and above, and ADC/MA to General officers.
- (f) The nameplate may be worn only by General and Senior officers, ADCs and Equerries when on parade, IAW [Chapter 3](#) and paragraph 4-5 to this annex.
- (g) Patent leather black boots or the issued R.M. Williams elastic sided, black leather boots may be worn when with ceremonial orders of dress (on parade), General Duty Dress (polyesters), General Duty Service Dress and mess dress orders of dress.
- (h) RA Inf WO2 and SNCO, and authorised members of the Corps of Staff Cadets and OCDTs.
- (i) Swords are worn when being received on parade, when in attendance to a dignitary being received on parade or when attending a ceremonial activity where other spectators or guests would be wearing swords.
- (j) When swords are worn they are carried in a steel scabbard with sword/sabre as applicable to Corps.
- (k) Only worn by those qualified members, IAW [Annex 4O](#).
- (l) General officers wear the gold and crimson silk waist sash. BRIG and COL wear crimson silk waist sash.

Figure 5B-1: Dress Order No SA 1 'Patrol Blue White Jacket'



DRESS ORDER NO SA2 'PATROL BLUE JACKET'

12. This order of dress is a ceremonial uniform which may be worn by those personnel authorised by Block Scale 3002/24, whilst employed in the position for which the uniform was issued. This order is also worn as a parade dress by entitled personnel in [Chapter 1](#).

13. It consists of the following items of dress:

Table 5B-3: Dress Order No SA 2 'Patrol Blue Jacket'

| Serial | Items of Dress | Remarks |
|--------|--|---|
| 1 | Aiguillette | Note (f) |
| 2 | Army Badge – embroidered on blue background | |
| 3 | Badge AIRN | If qualified |
| 4 | Badge commendation or soldiers medallion | If awarded |
| 5 | Badge ACB/ICB/MIB/RIB | If presented/awarded |
| 6 | Belt hooks | Note (b) |
| 7 | Belt web white/airmen's with Rising Sun Badge | Note (c) |
| 8 | Blue Service cap | Line 20 Australian Army Rising Sun buttons ^{Note (d)} |
| 9 | Collar badges | |
| 10 | Emblems of unit citation and/or awards | If awarded |
| 11 | Gloves white cotton | Note (c) |
| 12 | Gloves white kid leather | Note (e) |
| 13 | Gorget patches | For COL and above. Line 20 Australian Army Rising Sun buttons ^{Note (d)} |
| 14 | Insignia shoulder, 'AUSTRALIA' | |
| 15 | Nameplate | Not to be worn on parade Note (f) |
| 16 | Patent leather black boots or R.M. Williams elastic sided, black leather boots | Note (g) |
| 17 | Patrol Blue Jacket | Line 40 and line 30 Australian Army Rising Sun buttons Note (d) |
| 18 | Orders, decorations and medals | If awarded |
| 19 | Rank insignia | Officer rank to be pinned to shoulder cords |
| 20 | Sash scarlet | Note (h) |
| 22 | Shoulder cords | For officers |
| 23 | Slacks blue | |
| 24 | Socks black | |
| 25 | Sword and sword accessories | Notes (i) and (j) |
| 26 | Trade/skill qualification badge | Note (k) |
| 27 | Trousers blue | |

| Serial | Items of Dress | Remarks |
|--------|----------------|----------|
| 28 | Waist sash | Note (l) |

Notes:

- (a) Worn by those entitled officers in [Chapter 3](#).
- (b) Two brass belt hooks are used to support the Belt web white/airmen and are positioned to the side of the body when wearing the Belt.
- (c) Worn by Colour/Flag Party and members of the AFG, when ordered.
- (d) MAJGEN above are to wear General's buttons.
- (e) Worn by MAJGEN and above, and ADC/MA to General officers.
- (f) (The nameplate may be worn only by General and Senior officers, ADCs and Equerries when on parade, IAW [Chapter 3](#) and paragraph 4-5 to this annex.
- (g) Patent leather black boots or the issued R.M. Williams elastic sided, black leather boots may be worn when with ceremonial orders of dress (on parade), General Duty Dress (polyesters), General Duty Service Dress and mess dress orders of dress.
- (h) RA Inf WO2 and SNCO, and authorised members of the Corps of Staff Cadets and OCDTs.
- (i) Swords are worn when being received on parade, when in attendance to a dignitary being received on parade or when attending a ceremonial activity where other spectators or guests would be wearing swords.
- (j) When swords are worn they are carried in a steel scabbard with sword/sabre as applicable to Corps.
- (k) Only worn by those qualified members, IAW [Annex 4O](#).
- (l) General officers wear the gold and crimson silk waist sash. BRIG and COL wear crimson silk waist sash.

Figure 5B-2: Dress Order No SA 2 'Patrol Blue Jacket'



SENIOR OFFICER DRESS

INTRODUCTION

1. This annex provides orders of dress, embellishments and accoutrements which are relevant to Senior officers of COL rank and above. The CA may, from time to time, direct that a particular order of dress be worn for particular occasions.

GENERAL OFFICERS AND SENIOR OFFICERS IN CORPS APPOINTMENTS

2. Senior officers who are performing the functions of HOC/HOR are to wear the Corps lanyard with the appropriate orders of dress. General officers who are performing the functions of HOC/HOR are to wear the aiguillette with the appropriate orders of dress. No other Corps embellishments are worn.

ORDERS OF DRESS

General Duty and Ceremonial Dress

3. The orders for General Duty Dress and Ceremonial Dress worn by Senior officers are the same as those in [Chapter 5](#), except that gorget patches are worn in lieu of collar badges and gold 'AUSTRALIA' titles are worn in lieu of Corps/Regiment shoulder titles. General officers are to wear gold General's buttons. Senior officers are to wear gold Australian Army Rising Sun Badge buttons, in accordance with (IAW) [Chapter 3](#). General officers and selected/appointed Senior officers are to wear the aiguillette, IAW [Chapter 3](#).

4. General officers wear Dress Order No SO3–Ceremonial Service Dress General Officer, IAW Table 5C–4, when Ceremonial Parade Service Dress is appropriate or ordered, or at any time a sword/sabre is worn with Service Dress. Brown leatherwork with brass buckles and fittings is to be worn by General and Senior officers.

Ceremonial Patrol Blue orders of dress

5. Ceremonial Patrol Blue orders of dress are only worn by General officers of MAJGEN rank and above, special appointments and other selected personnel, IAW [Chapter 1](#) and [Annex 5B](#).

Dress Order No 6A 'Mess Dress' and Dress Order No 6B 'Mess Dress White Jacket'

6. Mess Dress and Mess Dress White Jacket is in [Annex 5O](#).

7. An officer of COL rank and above is to wear Staff Corps Mess Dress with the following exception:

ADM

5C–2

- a. Initially on promotion to COL, an officer may continue to wear the Mess Dress of the officer's previous allotted Corps. The uniform is worn without Corps collar badges, but with gold Australian Army Rising Sun buttons, badges of rank, embellishments and Corps shoulder straps.
- b. Specialist Service Officers (SSO) and Chaplains continue to wear the Mess Dress of their Corps or department. The Mess Dress worn by Senior SSO officers has the shoulder straps edged with gold lace as for Staff Corps Mess Dress and bullion badges of rank are worn.

Dress Order No 6C 'Senior Ranks Mess Dress' and Dress Order No 6D 'Mess Dress Army'

8. Senior Ranks Mess Dress and Mess Dress Army is in [Annex 5O](#).
9. An officer of COL rank and above is to wear the Senior Ranks Mess Dress. Initially on promotion to COL, an officer may continue to wear the Mess Dress of the officer's previous allotted Corps without Corps collar badges until the Senior Officers Mess Dress is issued. The uniform is worn with gold Australian Army Rising Sun buttons, gold 'AUSTRALIA' shoulder titles, badges of rank, embellishments.

HEADDRESS

General Duty Dress

10. With general duty orders of dress, Senior officers may wear the General Duty Hat KFF or beret, IAW [Chapter 3](#).

Ceremonial Dress

11. When on parade in Ceremonial Service Dress or Ceremonial Parade Dress, the Ceremonial Hat KKF is to be worn, IAW [Chapter 3](#). When not on parade, the Ceremonial Hat KFF is worn by all Senior officers with Ceremonial Dress, IAW [Chapter 3](#). The beret **is not** to be worn with any form of ceremonial orders of dress.

Ceremonial Patrol Blue orders of dress

12. The Blue Service cap is the only headdress to be worn with these orders of dress.

HAT, CAP AND BERET BADGES

General officer

13. General officers, MAJGEN and above wear a badge depicting the Royal Crest with crossed sword and baton within a wreath, made of gold embroidery with the blade of the sword in silver. On the Blue Service cap, the badge is affixed to a cap band of an appropriate colour as indicated in Table 5C–1. On the Hat KFF the badge is worn centrally on the front of the puggaree. The badge is in Figure 5C–1. The positioning of the badge is in paragraph 16 to this annex and Figure 5C–3.

Figure 5C-1: Hat and Cap Badge – General Officer



Senior officer

14. BRIG and COL wear a badge depicting the Royal Crest, in gold embroidery. On the Hat KFF the badge is worn centrally on the front of the puggaree. The badge is in Figure 5C-2. The positioning of the badge is in paragraph 17 to this annex and Figure 5C-4.

Figure 5C-2: Hat and Cap Badge – General Staff Officer and Senior Officer



15. A General or Senior officer is to wear the appropriate hat badge so that the badge is directly above the left eye when the beret is worn, IAW [Chapter 3](#), Figure 5C-3 and Figure 5C-4. A General or Senior officer is to only wear the Army/Service Blue beret during the circumstances or occasions in [Chapter 3](#). However a General or Senior officer fulfilling Head of Corps/Head of Regiment/honorary Colonel/COLCOMDT and other honorary appointments may wear the designated colour beret appropriate to that appointment when attending activities of the Corps or Regiment. A commander of a Corps specialist HQ may wear the designated colour beret appropriate to that appointment for the duration of their tenure.
16. General officer badges are positioned on headdress as follows:
- a. **Hat KFF.** Centrally on the puggaree with the lower edge of the badge level with the lower edge of the puggaree, as shown in Figure 5C-3.
 - b. **Blue Service cap.** Centrally on the front of the cap with the lower edge of the badge 1 cm above the chin strap, as shown in Figure 5C-3.
 - c. **Beret.** The lower edge of the badge is to be 5 mm above the top of the beret band, as shown in Figure 5C-3.

Figure 5C-3: Positioning the General Officer Badge on headdress



a. Hat KFFG2



b. Hat KFFG1



c. Blues Cap



d. Beret

17. Senior officer badges are positioned on headdress as follows:
- a. **Hat KFF.** Centrally on the puggaree with the lower edge of the badge backing level with the lower edge of the puggaree, as shown in Figure 5C-4.
 - b. **Blue Service cap.** Centrally on the front of the cap with the lower edge of the badge, not the backing, 1 cm above the chin strap as shown in Figure 5C-4.
 - c. **Beret.** The lower edge of the badge backing is to be on the top of the beret band, as shown in Figure 5C-4.

Figure 5C-4: Positioning the Senior Officer Badge on headdress



a. Hat KFFG2



b. Hat KFFG1



c. Blues Cap



d. Beret

GORGET PATCHES

18. Gorget patches are worn on the collars of polyester shirts and jackets by Senior and General officers. The Senior officers gorget patches are produced in pairs and in two sizes:

- a. **Large.** 9 cm long by 3 cm wide, worn on the Service Dress jacket, Utility jacket and Patrol Blue Jacket and Patrol White Jacket, IAW Figure 5C-5.
- b. **Small.** 5 cm long by 2.5 cm wide, worn on shirts and Ceremonial Safari Suit jacket, IAW Figure 5C-6.

19. Gorget patches are not worn when the polyester long sleeve shirt is worn only with the neck tie, ie Dress Order No 2B-Ceremonial Parade Dress Cold Weather; Dress Order No 2D- Ceremonial Dress Cold Weather and Dress Order No 2F-General Duty Dress Cold Weather.

Figure 5C-5: Gorget patches (large left and right) for Senior officers



Figure 5C-6: Gorget patches (small right and left) for Senior officers, facing the wearer



20. The large gorget patches worn by General officers have a centre line of gold oakleaf embroidery. The patches are worn so that the side with two acorns faces outwards towards the shoulders, IAW Figure 5C-7. The small size gorget patches worn by General officers have gold braid substituted for the oakleaf embroidery, IAW Figure 5C-8.

Figure 5C-7: Gorget patches (large right and left) for General officers, facing the wearer



Figure 5C-8: Gorget patches (small right and left) for General officers, facing the wearer



21. The gorget patches worn by BRIG and COL have a central line of silk gimp, the same colour as the gorget patch, except with RAANC, the central line of silk gimp is silver.

22. All gorget patches are triangular at the upper points. They are issued unfinished so that they may be shaped to fit individual garments. On jackets they are to be shaped to fit the collar above the 'vee', as shown in Figure 5C-9.

23. The colour of cap bands and gorget patches are in Table 5C-1.

Table 5C-1: Colour of cap bands and gorget patches

| Serial | Worn By | Colour |
|--------|---|--------------|
| 1 | General officers, BRIG and COL, except Serial 2-4 | Scarlet |
| 2 | RAA Ch D | Purple |
| 3 | RAAMC | Dull cherry |
| 4 | RAADC | Burnt orange |

Positioning the gorget patches

24. On the Service Dress jacket and Utility jacket, the large gorget patches are positioned with the lower edge coincident with the upper edge of the 'vee' and the outer edge coincident with the outer edge of the collar, as shown in Figure 5C-9. On the Patrol Blue Jacket and Patrol White Jacket, the gorget patches are positioned with the edges parallel to and equidistant from the collar line, with the pointed end to the rear and the other end flush with the collar closure edge, as shown in Figure 5C-9.

25. When the polyester shirt is worn as an outer garment, gorget patches are attached by clips and positioned coincident with and centrally on the forward edge of the collar with the outer edge of the patch parallel to the outer edge of the collar, as shown in Figure 5C-9.

Figure 5C-9: Positioning the gorget patches on garments

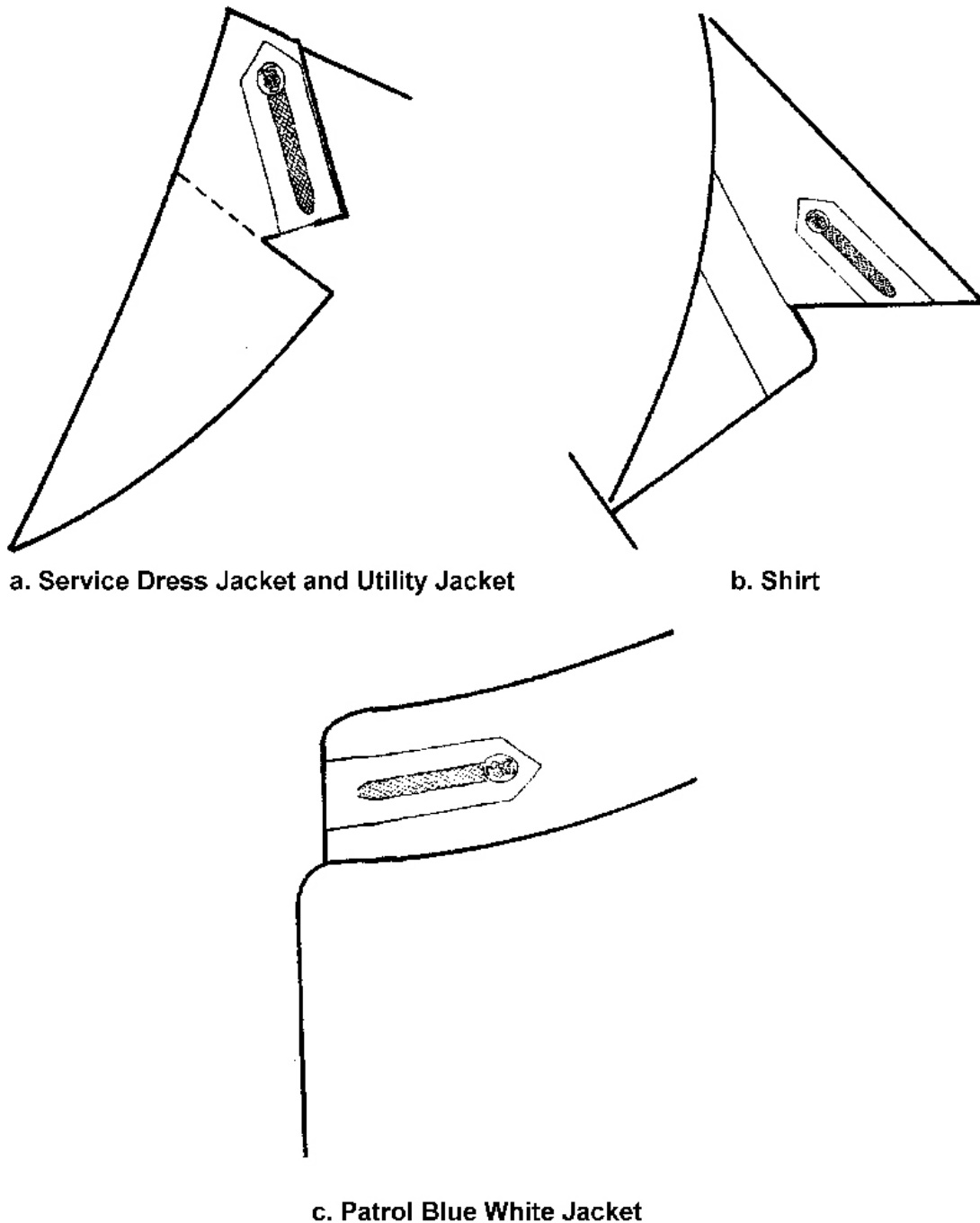

SHOULDER TITLES

26. General officers and Senior officers are to wear gold metal 'AUSTRALIA' shoulder titles at all times, with general duty (polyesters) and general duty Service dress, and ceremonial orders of dress, except when wearing embroidered rank slides. They are to be worn, IAW [Chapter 3](#).

RANK INSIGNIA

27. Rank insignia for General and Senior officers are in [Annex 4H](#). The crossed sword and baton insignia worn by General officers are worn with the points of the swords facing the front, IAW Figure 5C-10.

Figure 5C-10: Wearing crossed sword and baton insignia, facing the wearer



SWORDS AND OTHER CEREMONIAL ACCOUTREMENTS

28. Swords/Sabres, accessories and other ceremonial accoutrements worn by General and Senior officers are as follows:

a. **General officers:**

- (1) ceremonial sword (Mameluke), with steel scabbard
- (2) waist sash General officer gold and crimson silk, 5.5 cm wide, with 2 gold tassels
- (3) two red leather slings, 2.5 cm wide, faced with special pattern gold lace, the front sling is 51 cm long and the rear sling 89 cm
- (4) gold and crimson sword knot with acorn
- (5) shoulder cords General officer, but not worn with Ceremonial Service Dress
- (6) waist belt with shoulder suspender, for use with ceremonial slung sword.

b. Brigadier, Colonel and special appointments. IAW [Annex 5B](#).

29. The method of assembling and wearing sword equipment is in [Chapter 3](#).

SPECIAL ORDERS OF DRESS

30. The special orders of dress worn by General and Senior officers are in Table 5C-2.

Table 5C-2: Special Orders of Dress

| Dress Number | Dress Order Title | Table |
|--------------|--|-------|
| SO1 | Patrol Blue White Jacket Senior Officer | 5C-3 |
| SO2 | Patrol Blue Jacket Senior Officer | 5C-4 |
| SO3 | Ceremonial Service Dress General Officer | 5C-5 |
| SO4 | Staff Corps Senior Ranks Mess Dress | 5C-6 |

DRESS ORDER NO SO1 'PATROL BLUE WHITE JACKET SENIOR OFFICER'

31. Patrol Blue White Jacket Senior Officer is only worn by officers of MAJGEN rank and above, and entitled BRIG. Patrol Blue White Jacket Senior Officer may be ordered as an alternative to Mess Dress for Senior officers. It consists of the following items of dress:

Table 5C-3: Dress Order No SO1 'Patrol Blue White Jacket Senior Officer'

| Serial | Items of Dress | Remarks |
|--------|---|---|
| 1 | Aiguillette | Note (a) |
| 2 | Australian Army Rising Sun Badge embroidered Gold and Red on white background | |
| 3 | Badge AIRN | If qualified |
| 4 | Badge commendation or soldiers medallion | If awarded |
| 5 | Badge ACB/ICB/MIB/RIB | If presented/awarded |
| 6 | Blue Service cap with appropriate hat badge | Line 20 General's buttons |
| 7 | Emblems of unit citation and/or awards | If awarded |
| 8 | Gloves white kid leather | |
| 9 | Gorget patches | Line 20 General's buttons |
| 10 | Insignia shoulder, 'AUSTRALIA' | |
| 11 | Nameplate | Note (b) |
| 12 | Patent leather black boots, Black shoes or R.M. Williams elastic sided, black leather boots | Notes (c) and (d) |
| 13 | Patrol Blue White Jacket | Line 40 and line 30 General's buttons |
| 14 | Orders, decorations and medals | If awarded |
| 15 | Rank insignia | Officer rank to be pinned to shoulder cords |
| 16 | Shoulder cords | For officers |
| 17 | Slacks blue | |
| 18 | Socks black | |
| 19 | Sword and sword accessories | Notes (e) and (f) |
| 20 | Trade/skill qualification badge | Note (g) |
| 21 | Trousers blue | |
| 22 | Waist sash | Note (h) |

Notes:

(a) Worn by those entitled officers in [Chapter 3](#).

ADM

5C-13

- (b) The nameplate may be worn only by General and Senior officers, ADCs and Equerries when on parade, IAW [Chapter 3](#) and [Annex 5B](#).
- (c) Black shoes are no longer an IFI item and have been removed from the Block scale. Black shoes may be purchased from the area clothing store until current stocks are exhausted. Black shoes are optional and may continue to be worn until they become unserviceable. Black shoes may only be worn when worn as an alternative to Mess Dress.
- (d) Patent leather black boots or the issued R.M. Williams elastic sided, black leather boots may be worn when with ceremonial orders of dress (on parade), General Duty Dress (polyesters), General Duty Service Dress and mess dress orders of dress.
- (e) When worn as Ceremonial only.
- (f) General officers wear Mameluke sword. BRIG and COL wear steel scabbard and sword/sabre. A sword is not normally worn unless being received on parade or attending a ceremonial activity at which other spectators and guests would be wearing swords.
- (g) Only worn by those qualified members, IAW [Annex 4O](#).
- (h) General officers wear the gold and crimson silk waist sash. BRIG and COL wear crimson silk waist sash.

Figure 5C-11: Dress Order No SO1 'Patrol Blue White Jacket Senior Officer'



DRESS ORDER NO SO2 'PATROL BLUE JACKET SENIOR OFFICER'

32. Patrol Blue Jacket Senior Officer is only worn by officers of MAJGEN rank and above, and entitled BRIG. Patrol Blue Jacket Senior Officer may be ordered as an alternative to Mess Dress for Senior officers. It consists of the following items of dress:

Table 5C-4: Dress Order No SO2 'Patrol Blue Jacket Senior Officer'

| Serial | Items of Dress | Remarks |
|--------|--|---|
| 1 | Aiguillette | Note (a) |
| 2 | Australian Army Rising Sun Badge embroidered blue/black background | |
| 3 | Badge AIRN | If qualified |
| 4 | Badge commendation or soldiers medallion | If awarded |
| 5 | Badge ACB/ICB/MIB/RIB | If presented/awarded |
| 6 | Blue Service cap with appropriate hat badge | Line 20 General's buttons |
| 7 | Emblems of unit citation and/or awards | If awarded |
| 8 | Gloves white kid leather | |
| 9 | Gorget patches | Line 20 General's buttons |
| 10 | Insignia shoulder, 'AUSTRALIA' | |
| 11 | Nameplate | Note (b) |
| 12 | Patent leather black boots, Black shoes or R.M. Williams Elastic sided black leather boots | Notes (c) and (d) |
| 13 | Patrol Blue Jacket | Line 40 and line 30 General's buttons |
| 14 | Orders, decorations and medals | If awarded |
| 15 | Rank insignia | Officer rank to be pinned to shoulder cords |
| 16 | Shoulder cords | For officers |
| 17 | Slacks blue | |
| 18 | Socks black | |
| 19 | Sword and sword accessories | Notes (e) and (f) |
| 20 | Trade/skill qualification badge | Note (g) |
| 21 | Trousers blue | |
| 22 | Waist sash | Note (h) |

Notes:

- (a) Worn by those entitled officers in [Chapter 3](#).
- (b) The nameplate may be worn only by General and Senior officers, ADCs and Equerries when on parade, IAW [Chapter 3](#) and [Annex 5B](#).
- (c) Black shoes are no longer an IFI item and have been removed from the Block scale. Black shoes may be purchased from the area clothing store until current stocks are exhausted. Black shoes are optional and may continue to be worn until they become unserviceable. Black shoes may only be worn when worn as an alternative to Mess Dress.
- (d) Patent leather black boots or the issued R.M. Williams elastic sided, black leather boots may be worn when with ceremonial orders of dress (on parade), General Duty Dress (polyesters), General Duty Service Dress and mess dress orders of dress.
- (e) When worn as Ceremonial only.

ADM

5C–16

- (f) General officers wear Mameluke sword. BRIG and COL wear steel scabbard and sword/sabre. A sword is not normally worn unless being received on parade or attending a ceremonial activity at which other spectators and guests would be wearing swords.
- (g) Only worn by those qualified members, IAW [Annex 4O](#).
- (h) General officers wear the gold and crimson silk waist sash. BRIG and COL wear crimson silk waist sash.

Figure 5C–12: Dress Order No SO2 ‘Patrol Blue Jacket Senior Officer’

TBI

**DRESS ORDER NO SO3 ‘CEREMONIAL SERVICE DRESS
GENERAL OFFICER’**

33. Ceremonial Service Dress General Officer is only worn by officers of MAJGEN rank and above, and entitled BRIG. It consists of the following items of dress:

Table 5C–5: Dress Order No SO3 ‘Ceremonial Service Dress General Officer’

| Serial | Item of Dress | Remarks |
|--------|--|---|
| 1 | Aiguillette | Note (a) |
| 2 | Australian Army Rising Sun Badge embroidered on khaki background | |
| 3 | Badge AIRN | If qualified |
| 4 | Badge commendation or soldiers medallion | If awarded |
| 5 | Badge ACB/ICB/MIB/RIB | If presented/awarded |
| 6 | Belt Sam Browne, shoulder strap | Note (b) |
| 7 | Emblems of unit citation and/or awards | If awarded |
| 8 | Gorget patches | Line 20 General’s buttons |
| 9 | Hat KFF | Brim up |
| 10 | Insignia shoulder, ‘AUSTRALIA’ | |
| 11 | Jacket Service dress | Line 30 General’s buttons |
| 12 | Nameplate | Note (d) |
| 13 | Necktie khaki polyester | |
| 14 | Orders, decorations and medals | If awarded |
| 15 | Patent leather black boots or R.M. Williams elastic sided, black leather boots | Note (e) |
| 16 | Rank insignia | Officer rank to be pinned to shoulder cords |
| 17 | Shirt polyester long sleeve | |
| 18 | Slacks service dress | |

AL5

| Serial | Item of Dress | Remarks |
|--------|---------------------------------|-------------------|
| 19 | Socks khaki | |
| 20 | Sword and accessories | Notes (f) and (g) |
| 21 | Trade/skill qualification badge | Note (h) |
| 22 | Trousers service dress | |

Notes:

- (a) Worn by those entitled officers in [Chapter 3](#).
- (b) All General and Senior officers are to wear brown leatherwork with brass buckles and fittings.
- (c) The nameplate may be worn only by General and Senior officers, ADCs and Equerries when on parade, IAW [Chapter 3](#) and [Annex 5B](#).
- (d) Patent leather black boots or the issued R.M. Williams elastic sided, black leather boots may be worn when with ceremonial orders of dress (on parade), General Duty Dress (polyesters), General Duty Service Dress and mess dress orders of dress.
- (e) When worn as Ceremonial only.
- (f) A sword is not normally worn unless being received on parade or attending a ceremonial activity at which other spectators and guests would be wearing swords.
- (g) Only worn by those qualified members, IAW [Annex 4O](#).

Figure 5C-13: Dress Order No SO3 'Ceremonial Service Dress General Officer'



DRESS ORDER NO SO4 'STAFF CORPS SENIOR RANKS MESS DRESS'

34. Staff Corps Senior Ranks Mess Dress is worn by an officer of COL rank and above with the following exceptions:

- a. Initially on promotion to COL, an officer may continue to wear the Mess Dress of the officer's previous allotted Corps. The uniform is worn without Corps collar badges, but with Army buttons, badges of rank and embellishments.
- b. A senior General Staff Officer in a Corps appointment may wear Mess Dress with all Corps embellishments.

35. This order of dress is **not** to be worn from 01 January 2022. It consists of the following items of dress:

Table 5C-6: Dress Order No SO4 'Staff Corps Senior Ranks Mess Dress'

| Serial | Item of Dress | Remarks |
|--------|--|--|
| 1 | Australian Army Rising Sun Badge bullion embroidered on black/blue background | |
| 2 | Aiguillette | Note (a) |
| 3 | Badge commendation or soldiers medallion–miniature | If awarded |
| 4 | Badge ACB/ICB–miniature | If presented/awarded |
| 5 | Badge metal FFI PJI/PJI/PJM–miniature | If presented/awarded |
| 6 | Badge metal aircrew–miniature | If presented |
| 7 | Bow tie black | |
| 8 | Chain jacket | Note (b) |
| 9 | Emblems of unit citation and/or awards–miniature | If awarded |
| 10 | Insignia shoulder, 'AUSTRALIA' | |
| 11 | Jacket Staff Corps Senior Officer | Line 30 Australian Army Rising Sun buttons ^{Note (c)} |
| 12 | Orders, decorations and medals–miniature | If awarded |
| 13 | Patent leather black boots, Black shoes, black Court shoes or R.M. Williams elastic sided, black leather boots | Notes (d) and (e) |
| 14 | Rank insignia | Bullion rank to be sewn onto epaulette |
| 15 | Shirt white Marcella front | |
| 16 | Skirt blue | Note (f) |
| 17 | Slacks blue | Notes (f) and (g) |
| 18 | Socks black | |
| 19 | Stockings/pantihose black | |
| 20 | Studs shirt | Note (h) |
| 21 | Trade/skill qualification badge | Note (i) |
| 22 | Trousers blue | |

| Serial | Item of Dress | Remarks |
|--------|-----------------|---|
| 23 | Waistcoat Corps | Line 20 Australian Army Rising Sun buttons ^{Note (j)} |

Notes:

- (a) Worn by those entitled officers in [Chapter 3](#).
- (b) Members are to wear either the silver or gold chain appropriate to Corps, if applicable. MAJGEN and above wear gold General's buttons and gold chain, IAW [Annex 5O](#).
- (c) Collar badges are only worn by Senior officers when attending as HOC/HOR or Corps Honorary appointment. MAJGEN and above wear gold General's buttons.
- (d) Black shoes are no longer an IFI item and have been removed from the Block scale. Black shoes may be purchased from the area clothing store until current stocks are exhausted. Black shoes are optional and may continue to be worn until they become unserviceable.
- (e) Patent leather black boots or the issued R.M. Williams elastic sided, black leather boots may be worn when with ceremonial orders of dress (on parade), General Duty Dress (polyesters), General Duty Service Dress and mess dress orders of dress.
- (f) Women can wear Court shoes when the skirt, slacks or trousers are worn.
- (g) Women may purchase Slacks black as an optional item on repayment and may wear them in lieu of the Skirt black.
- (h) Shirt studs are to be plain gold or silver appropriate to Corps, if applicable, IAW [Annex 5O](#). MAJGEN and above wear gold buttons.
- (i) Only worn by those qualified members, IAW [Annex 4O](#).
- (j) Watch/fob chains are not to be worn.

Figure 5C-14: Dress Order No S04 'Staff Corps Senior Ranks Mess Dress'



BAND CEREMONIAL DRESS

GENERAL

1. Band ceremonial orders for dress, both military and pipe and drum bands are provided and maintained at public expense and/or via the additional IFI of items which thereafter, will be maintained by the member using uniform allowance. Uniforms of a historical pattern approved by Corps/Regimental committees and AHQ are to be procured and maintained at Unit/Regimental expense and are worn for ceremonial purposes by Army bands within Australia only.
2. Ceremonial Dress for pipes and drums are in [Annex 5E](#).

WEARING BAND CEREMONIAL DRESS

3. The appropriate band ceremonial orders for dress are a command decision by local AABC OC; however, the following guidance is provided.
 - a. a ceremonial activity includes a formed body of troops and at least one formal arrival
 - b. a concert that commences with the Australian National Anthem and/or fanfare is not considered a ceremonial activity
 - c. when playing a bugle call as part of a concert the bugler is to be given suitable time to change into Ceremonial Parade Service Dress or Ceremonial Parade Dress
 - d. non-ceremonial activities requiring the playing of a Vice-Regal salute as a precursor will not require headdress to be worn
 - e. when performing outdoors and headdress is required, for workplace health and safety and/or ceremonial reasons, the band ceremonial orders for dress will be those that include the Hat KFF.
4. Bands are to wear the following orders of dress for ceremonial activities:
 - a. Dress Order No 1A—Ceremonial Parade Service Dress.
 - b. Dress Order No 2A—Ceremonial Parade Dress.
5. The Band of RMC may continue to wear Dress Order No BC1—No 1 AABC Ceremonial Dress (RMC–D) with White or Blue Jacket and Blue Service cap, in accordance with (IAW) Table 5D–2, on specific occasions when the Corps of Staff Cadets are wearing Patrol Blue Orders of Dress, IAW [Annex 5J](#). This order of dress is not to be procured at public expense.
6. Bands are to wear the following orders of dress as appropriate to the occasion for outdoor concerts:

OFFICIAL

ADM

5D-2

- a. Dress Order No 1C 'General Duty Service Dress'
 - b. Dress Order No 2E 'General Duty Dress (polyesters)'
 - c. Dress Order No 4A 'General Duty Dress (AMCU).
7. Mess Dress Army may be worn by all AABC members whilst performing indoor concert activities. Mess Dress Army is to be procured and maintained at public expense for all AABC members.
8. Fanfare teams are to wear headdress when performing independently of the main ensemble. However, when the fanfare team is embedded within the ensemble as part of a larger performance, headdress is not to be worn.

Dress for travel

9. General Duty Dress (AMCU) is to be worn during the loading, unloading and set-up of band equipment.
10. Dress for local travel is to be General Duty Dress (AMCU). Neat civilian attire may be worn where security is assessed as being a risk to personnel. A unit polo shirt or jacket is to be worn in lieu of the Service Dress Jacket or polyester khaki shirt until arrival at the destination, where band members may continue to dress in the appropriate order of dress for the occasion, as required.
11. Travel in white T-shirts or another combination of non-military apparel is not permitted.

TECHNICAL PERSONNEL

12. Dress for personnel involved in technical support during rehearsals and concerts are to wear General Duty Dress (AMCU).

ITEMS OF DRESS

Blue Service cap

13. Bands are to wear the Blue Service cap with OR pattern and officer pattern, as appropriate. Officers of MAJ rank and above are to embellish the cap brim with gold braid.
14. Blue Service cap is worn by the Band of RMC, when Patrol Blue Orders of Dress is worn by the Corps of Staff Cadets. The Blue Service cap is worn by other bands when Mess Dress Army is worn. The wearing of the cap is in [Chapter 3](#). The position of the cap badge is in [Chapter 4](#) and [Annex 4D](#).

BC1—No 1 Australian Army Band Corps Ceremonial Dress (Royal Military College – Duntroon) with Blue/White Jacket

15. BC1—No 1 AABC Ceremonial Dress (RMC-D) with Blue/White Jacket is worn only by the Band of RMC, when Patrol Blue Orders of Dress is worn by the Corps of Staff Cadets. AABC officers are to wear rank insignia on gold shoulder cords on the jacket, IAW [Chapter 3](#). AABC ORs are to wear shoulder boards

AL5

OFFICIAL

appropriate to the uniform. AABC WOs of the Band of RMC are to wear embroidered badges appropriate to the uniform. AABC NCOs of the Band of RMC are to wear embroidered badges appropriate to the uniform.

16. The position of embellishments is in [Chapter 4](#). A plain white T-shirt is to be worn at all times under the jacket.

Trousers and slacks blue

17. Trousers blue for males only and slacks blue for females only are worn only by the Band of RMC, when Patrol Blue Order of Dress is worn by the Corps of Staff Cadets. Trousers and slacks blue is worn with a 1 cm scarlet stripe. Braces may be worn with trousers and white braces are to be worn under the white jacket.

Footwear

18. Bands are to wear patent leather black boots, elastic sided black leather boots or court shoes with Band Ceremonial Dress, IAW [Chapter 3](#).

Swords

19. Swords are worn, IAW [Chapter 3](#) and as follows:

- a. When bands are on Parade in ceremonial parade orders of dress, swords with leather equipment and the Sam Browne Belt are worn by officers and WO1, IAW the relevant orders for dress in [Chapter 5](#).
- b. Drum Major and WO2 Bandmasters wear swords appropriate to Corps with white slung equipment.

Gauntlets

20. Drum Major, cymbal players and bass drummers are to wear white leather gauntlets.

Drum Major Sash

21. The Drum Major Sash is worn when on parade with marching bands. Medals and other embellishments to which members are entitled to wear are worn on the left breast of the sash. Medals and badges are positioned, IAW Figure 5D-1.

Figure 5D-1: Positioning the medals on the Drum Major Sash



Mourners band

22. The mourners' band is to be worn by those persons performing the duties of Music Director, Bandmaster and the Drum Major, WO1 Band Sergeant Major, IAW [Chapter 3](#).

ROYAL MILITARY COLLEGE SPECIAL ORDERS OF BAND CEREMONIAL DRESS

23. The Band of RMC special orders for band ceremonial dress is in Table 5D-1.

Table 5D-1: Royal Military College Special Orders of Band Ceremonial Dress

| Dress Number | Dress Order Title | Table |
|--------------|-----------------------------------|-------|
| BC1 | No1 AABC Ceremonial Dress (RMC-D) | 5D-2 |

**DRESS ORDER NO BC1—NO 1 AUSTRALIAN ARMY BAND CORPS
CEREMONIAL DRESS (ROYAL MILITARY COLLEGE – DUNTROON)**

24. This order of dress is worn only by AABC members of the Band of RMC, when on parade with armed troops or when the occasion is appropriate, when the Patrol Blue Orders of Dress is worn by the Corps of Staff Cadets. It consists of the following items of dress:

Table 5D–2: Dress Order No BC1—No 1 AABC Ceremonial Dress (Royal Military College – Duntroon)

| Serial | Item of Dress | Remarks |
|--------|---|---|
| 1 | Australian Army Rising Sun Badge | |
| 2 | Badge AIRN | If qualified |
| 3 | Badge commendation or soldiers medallion | If awarded |
| 4 | Badge ACB/ICB/MIB/RIB | If presented/awarded |
| 5 | Blue Service cap with appropriate hat badge | Line 20 Australian Army Rising Sun buttons |
| 6 | Ceremonial waist sash, rifle green | For AABC officers only |
| 7 | Collar badges, AABC | |
| 8 | Dress cord, AABC | Note (a) |
| 9 | Emblems of unit citation and/or awards | If awarded |
| 10 | Gauntlets white | Note (b) |
| 11 | Patent leather black boots, Black shoes, black Court shoes or R.M. Williams Elastic sided black leather boots | Note (c) |
| 12 | Orders, decorations and medals | If awarded |
| 13 | Rank insignia | Officer rank to be pinned to shoulder cords ^{Note (d)} |
| 14 | Sash Drum Major | Note (e) |
| 15 | Shoulder boards, AABC pattern | For ORs only ^{Note (f)} |
| 16 | Shoulder cords | For officers only |
| 17 | Slacks blue, AABC pattern | |
| 18 | Socks black | |
| 19 | Sword and accessories | Note (g) |
| 20 | Trade/skill qualification badge | Note (h) |
| 21 | Trousers blue, AABC pattern | |
| 22 | White braces | |
| 23 | White T-shirt | |
| 24 | White or Blue jacket, AABC | Line 40 Australian Army Rising Sun buttons |

Notes:

- (a) Worn on order by OC Band or Music Director.
- (b) Worn by Drum Major, cymbal players and bass drummer.
- (c) Patent leather black boots or the issued R.M. Williams elastic sided, black leather boots may be worn when with ceremonial orders of dress (on parade), General Duty Dress (polyesters), General Duty Service Dress and mess dress orders of dress.
- (d) WOs embroidered gold on white background and NCOs on rifle green background.
- (e) Worn by Drum Major when performing with a marching band.
- (f) Shoulder boards are worn only on the white jackets.
- (g) Worn by designated personnel when on parade with armed troops. Worn by AABC officers and AABC WO1 performing the duties of Music Director.
- (h) Only worn by those qualified members, IAW [Annex 4O](#).

Figure 5D-2: Dress Order No BC1—No 1 Australian Army Band Corps Ceremonial Dress (Royal Military College – Duntroon)



Figure 5D-3: Dress Order No BC1—No 1 Australian Army Band Corps Ceremonial Dress (Royal Military College – Duntroon), with Dress Cord Australian Army Band Corps



SCOTTISH DRESS

GENERAL

1. Since 1788 when British Marines first stepped onto Australian soil there has been a close cultural and traditional link between the British and Australian Armies. The arrival of COL Lachlan Macquarie in 1809 with his Regiment, the 73rd Regiment of Foot and the Royal Highlanders embraced many of the Scottish traditions of the British forces including Highland uniforms and Pipes and Drums. Today these traditions continue within the 'kilted' companies of the ARes and the Pipes and Drums of the Australian Army.

RESPONSIBILITY FOR PROVISION OF TECHNICAL ADVICE

2. The Pipes and Drums Section of the Defence Force School of Music is responsible to provide advice to AHQ on historic and technical aspects of Scottish Dress and equipment.

AUTHORITY FOR WEARING SCOTTISH DRESS

3. Scottish Dress is authorised to be worn for identified positions of the following units:

- a. 2/17 RNSWR – Black Watch tartan
- b. the Scottish sub-unit of 41 RNSWR – Black Watch tartan with Argyle Sett
- c. 5/6 RVR – Gordon tartan
- d. 10/27 RSAR – Mackenzie Seaforth tartan
- e. B Coy, 16 RWAR – Cameron tartan and those personnel are to wear the Bonnet Glengarry with appropriate orders of dress
- f. ADFA Pipes and Drums – ADFA tartan
- g. RACT Pipes and Drums – Murray tartan
- h. AABC Pipes and Drums – Australian tartan
- i. individual RAR Battalion Pipes and Drums – Individual battalion tartan, when on parade as a single entity
- j. RAR Battalion Pipes and Drums – Australian tartan, when on parade as a regiment, en masse, or with other units.

4. The following identified positions are authorised to wear Scottish Dress:

ADM

5E-2

- a. Regimental ADJT (Directorate of Infantry) and the ADJT of authorised units
- b. an officer posted to HQ 2/17 RNSWR, HQ 41 RNSWR, HQ 5/6 RVR, HQ 10/27 RSAR or HQ 16 RWAR who has served in the Scottish sub-unit
- c. a member of ADFA Pipes and Drums, and only when performing those duties
- d. a member of RACT Pipes and Drums, and only when performing those duties
- e. a member of AABC Pipes and Drums, and only when performing those duties
- f. a member of RAR and RA Inf Pipes and Drums, and only when performing those duties
- g. a piper or drummer authorised by the Director of Music–Army (DMUS–A).

PROVISION OF SCOTTISH DRESS

5. The provision of Scottish Dress is in accordance with (IAW) Block Scales 3002/20 (part 4) and 3002/23. The provision of any other items of dress, worn IAW regimental or battalion custom is to be at the units or members' expense.

WEARING OF SCOTTISH DRESS

6. Scottish items of dress are to be worn IAW the customs and traditions of Scottish units.
7. Scottish orders of dress are to be worn by authorised units and sub-units during general duty, ceremonial and mess occasions. Scottish orders of dress are to conform to the Australian Army orders of dress, worn by the parent unit. When ceremonial orders of dress are worn by the unit, members authorised to wear Scottish Dress are to wear the ceremonial orders of that particular dress, similarly with general duty and mess dress orders of dress.
8. A member of a Scottish sub-unit is to conform to field dress orders of dress for the unit.
9. A member of a pipes and drums may wear mixed Scottish and Australian items of dress when only authorised by DGPERS–A.
10. Scottish Dress is embellished in the same manner as Service Dress, IAW [Chapter 4](#).

ITEMS OF DRESS

Bonnet Glengarry

11. The Bonnet Glengarry is a boat-shaped cap without a peak made of thick-milled woollen material, with a toorie (pompom) on top and ribbons hanging downwards behind, capable of being folded flat. The Bonnet Glengarry has a plain (for pipers) or chequered (for drummers) headband and is worn with the headband

2.5 cm above eyebrow, canted to the right slightly, and with point of Glengarry aligned with nose. Tapes are to be pressed and without creases.

12. The regimental headdress badge for the Bonnet Glengarry, is to be worn centrally on a rosette, or regimental tartan patch, approximately 9 cm square. The regimental badge may be backed by a coloured cloth, IAW regimental or battalion custom. The tartan patch may be fringed or frayed at the edges according to regimental custom. The tartan patch is positioned on the left side of the bonnet.

13. When performing band activities whilst wearing General Duty Dress (AMCU), Pipers and Drummers are to wear the Bonnet Glengarry.

Claymore and cross belt

14. The Claymore and cross belt is a leather, black web or PVC belt which is worn when wearing ceremonial orders of dress. The Claymore and cross belt is worn over the right shoulder, crossing the body with the bottom edge of the cross belt on the left hip. The Claymore and cross belt is fitted with silver buckles, and is worn by all pipers and drummers.

Dirk

15. The Scottish Dirk is a large double-edged knife that is a part of traditional Scottish Dress which is worn when wearing ceremonial orders of dress. The knife is approximately a 30 cm blade that is fitted with a scabbard which is attached to a 'frog' and is supported by the Regimental waist belt. The Dirk is worn on the right side of the body. The Dirk is an optional item of dress and is only worn by the Pipe Major and/or Drum Major.

Garter/Regimental flashes

16. Garter/Regimental flashes support hose-tops and are designed, IAW regimental or battalion custom. Both flashes are to be worn at equal length on both legs with the leading edge of the front flash is to be vertically up the front of leg, bisecting the top diamond of the hose or hose-top.

Gaiters highland

17. Gaiters highland were originally designed to protect the ankles of soldiers when operating in rugged terrain. The gaiters, also known as spats, should be a firm fit close to the ankle and calf of the legs. The points of gaiters are to be in line with the rear seam of the hose, centre-rear of the leg, with the buttons to the outside. The colour of gaiter buttons is to be, IAW regimental custom.

Gillie Brogues

18. Gillie Brogues are tongue-less shoes with long tasselled laces. Gillie Brogues are worn with general duty and mess dress orders of dress, IAW with regimental custom. Gillie Brogues laces are tied from the front of the shoe, pulling the laces reasonably tight then twisting them around each other 3 to 6 times. At the rear of the leg, pull the laces tight then again twist them around each other 2 to 4 times. It should wrap no more than 4 cm above the ankle bone and then tie the knot on the

outside of the leg. The dangling tassels on the knot should not be more than 7 cm long and should be of even length.

Highland Dress jacket

19. The Highland Dress jacket, including the Pipes and Drums pattern is worn with ceremonial and general duty orders of dress in the same manner, IAW [Chapter 5](#). The modified cut-away version of the Highland Dress jacket may be varied from an up-side-down 'U' shape cut-out or a rounded or taped corner cut-out.

Hose-tops

20. Hose-tops are diced socks that may be either full or half (footless). Hose-tops are worn with gaiters highland when wearing ceremonial orders of dress. The pattern of hose-tops is IAW regimental or battalion custom. Hose-tops are worn with the folded upper edge three fingers breadth below outside bone of the knee with the adjacent edges of the common two diamonds touching. The top of hose-top is worn level, side-to-side and front-to-back with the seam of the hose-top worn in the centre rear of the leg.

Kilt regimental

21. The Regimental kilt is worn with the apron, un-pleated, facing the front of the body. The Tartan Sett of the apron is to run vertically through the centre of the body with the fringe of the apron on the right side. The apron may be secured with a kilt pin. The bottom of the kilt is to rest just above the half way mark of the knee cap and the hem is to be even in height from front to rear and side to side. The inside and outside aprons are securely fastened by buckles and when buckled on the tightest holes of the straps, the kilt should not be so loose that the wearer can easily twist the kilt around the body; nor should it be so tight when buckled on the loosest holes of the straps that it causes 'scalloping' of the fabric where it is buckled.

22. The kilt will be made with four holes in the straps and it is made to fit on the second, tightest hole. If the holes on the straps are insufficient to accommodate size changes, extra adjustment can be achieved by moving the straps and buckles at the over-apron waist and hip and the under-apron strap. Kilts are often made with extra material in the kick pleats or an apron edge to accommodate alteration of the garment, although it is not advisable to reconstruct a kilt too much as it was made to a certain size originally. Kilts are to be dry cleaned and pressed ensuring the pleats are as straight as possible from the bottom of the fell to the bottom of the kilt, thus preserving the look of the sett when the kilt is worn.

23. To wear the kilt without underwear is often referred to as 'going regimental' and is considered by some to be the traditional practice; however, there is no official policy regarding the wearing of undergarments with kilts in the Army.

Regimental waist belt

24. The Regimental waist belt is a leather, black web or PVC belt which supports the dirk when wearing ceremonial orders of dress. The buckle may be embellished with the Army or Regimental Badge, IAW regimental or battalion custom. The belt is worn firm to body to allow only one finger to be inserted between the belt and body.

The top of the belt is to be level with the top of the kilt and the buckle is to be centred at the front of the body.

Sash Drum Major

25. The Drum Major Sash is embellished with regimental embellishments including badge and battle honours, and is worn when wearing ceremonial parade orders of dress. It is to be worn, IAW [Annex 5D](#).

Sash scarlet

26. The scarlet sash is worn by entitled RA Inf personnel, SCDTs and OCDTs when wearing ceremonial and mess dress orders of dress. When worn with pipes and drums ceremonial orders for dress, entitled RAR and RA Inf pipes and drums personnel are to wear the sash over the left shoulder, crossing the body with the bottom edge of the sash on the right hip. With all other orders for dress, the sash is worn, IAW [Chapter 3](#).

Sgian-dubh

27. The Sgian-dubh, pronounced 'skee-an-doo' is a small, single-edged knife that is a part of traditional Scottish Dress which is worn when wearing ceremonial orders of dress. The Sgian-dubh is tucked vertically into the top of the outer-right leg hose-top so the blade is pointing downwards, in between the skin and the stocking with only the upper portion of the hilt to be visible. If the wearer is left-handed, the Sgian-dubh may be worn on the left leg. The Sgian-dubh is an optional item of dress and is only worn by the Pipe Major and/or Drum Major.

Sporran Ceremonial, long hair

28. The regimental hair sporran was originally, an ammunition or ration pouch and is only worn when wearing ceremonial orders of dress. It usually has a metal clasp-top adorned with the regimental badge supporting two or more tassels according to regimental custom. The sporran strap is fitted snugly with the pointed end of strap, non-buckle end pointing to right hip and adjusted according to the size of the wearer. The top of the sporran is one hand's breadth below waist belt buckle; however, the hair of the sporran should not hang further than 2 cm below the kilt. The sporran should square the area between the hips and the knees, and hang at a natural arc from the hip. Hair sporrans are not trimmed to length and all parts are to be clean, in good order, and neatly brushed. When worn with a drum, the sporran is to be placed to the right hand side of the body, placed centrally on the right buttock.

Sporran dress

29. The sporran dress may be leather or imitation seal skin according to regimental custom. The regimental dress sporran is only worn when wearing general duty and mess dress orders of dress. It usually has a metal clasp-top adorned with the regimental badge supporting two or more tassels according to regimental custom. The sporran strap is fitted snugly with the pointed end of strap, non-buckle end pointing to right hip and adjusted according to the size of the wearer. The top of the sporran is one hand's breadth below waist belt buckle. The sporran should square the area between the hips and the knees and hang at a natural arc from the hip. When worn with a drum, the sporran is to be placed to the right hand side of the body, placed centrally on the right buttock.

Tartan Australian

30. When two or more RAR Battalion Pipes and Drums Bands are on parade as a regiment, en masse, or with other units, they are only authorised to wear the Australian tartan. For example, if 6 RAR and 7 RAR are together conducting a ceremonial parade or event, with or without other units, both battalion Pipes and Drums Bands are to wear the Australian tartan.

Tartan battalion

31. When an individual RAR Battalion Pipes and Drums Band is on parade, as a single entity, it is authorised to wear the respective battalion tartan. For example, if 8/9 RAR is conducting a unit ceremonial parade or event, the Pipes and Drums Band is authorised to wear the MacArthur tartan. If an individual RAR Battalion Pipes and Drums Band do not own a unique to battalion tartan, it is to wear the Australian tartan.

32. The individual RAR battalion tartan is as follows:

- a. 2 RAR – Australian tartan
- b. 3 RAR – Royal Stewart tartan (Scots Guards)
- c. 5 RAR – Australian tartan
- d. 6 RAR – Black Watch tartan
- e. 7 RAR – Gordon tartan (The Highlands)
- f. 8/9 RAR – MacArthur tartan.

SCOTTISH ORDERS OF DRESS

33. The Scottish orders of dress are in Table 5E-1.

Table 5E-1: Orders for Dress

| Dress Number | Dress Order Title | Table |
|--------------|--|-------|
| SD1A | Scottish Ceremonial Parade Service Dress | 5E-2 |
| SD1B | Scottish Ceremonial Service Dress | 5E-3 |
| SD1C | Scottish General Duty Service Dress | 5E-4 |
| SD2A | Scottish Ceremonial Parade Dress | 5E-5 |
| SD2B | Scottish Ceremonial Dress | 5E-6 |
| SD2C | Scottish General Duty Dress | 5E-7 |
| SD3 | Scottish Mess Dress | 5E-8 |
| 4A | General Duty Dress (Disruptive Pattern Camouflage Uniform)–Pipes and Drums | 5E-9 |
| SD5W | Scottish Ceremonial Dress White Jacket | 5E-10 |
| SD5G | Scottish Ceremonial Dress Green Jacket | 5E-11 |

DRESS ORDER NO SD1A 'SCOTTISH CEREMONIAL PARADE SERVICE DRESS'

34. This order of dress is worn by authorised personnel only on Scottish ceremonial parades, including mounted parades, other than AFV parades, when the wearing of a jacket is appropriate. It consists of the following items of dress:

Table 5E-2: Dress Order No SD1A 'Scottish Ceremonial Parade Service Dress'

| Serial | Item of Dress | Remarks |
|--------|--|---|
| 1 | Australian Army Rising Sun Badge embroidered on khaki background | |
| 2 | Badge AIRN | If qualified |
| 3 | Badge commendation or soldiers medallion | If awarded |
| 4 | Badge ACB/ICB/MIB/RIB | If presented/awarded |
| 5 | Belt black | Note (a) |
| 6 | Belt Sam Browne and shoulder strap | Note (b) |
| 7 | Bonnet Glengarry | Regimental or battalion custom pattern with appropriate hat badge |
| 8 | Claymore and cross belt | Pipers and drummers |
| 9 | Dirk | Optional, only worn by Pipe and/or Drum Major |
| 10 | Emblems of unit citation and/or awards | If awarded |
| 11 | Gaiters Highland with Patent leather black boots or R.M. Williams elastic sided, black leather boots | Note (c) |
| 12 | Garter/Regimental flashes | Regimental or battalion custom pattern |
| 13 | Gauntlets white | Note (d) |
| 14 | Hose-tops | Diced Australian tartan pattern, regimental or battalion custom pattern |
| 15 | Highland dress jacket modified cut-away | Line 40 Australian Army Rising Sun buttons |
| 16 | Kilt Australian, regimental or battalion tartan | Australian tartan pattern, regimental or battalion custom pattern |
| 17 | Lanyard, collar badges and insignia, 'AUSTRALIA' | |
| 18 | Necktie khaki polyester | |
| 19 | Orders, decorations and medals | If awarded |
| 20 | Rank insignia | Officer rank to be pinned to epaulette |

| Serial | Item of Dress | Remarks |
|--------|---------------------------------|---|
| 21 | Sash Drum Major | Note (e) |
| 22 | Sash Scarlet | Note (f) |
| 23 | Sgian-dubh, black | Optional, only worn by Pipe and/or Drum Major |
| 24 | Shirt polyester long sleeve | |
| 25 | Shirt khaki polyester | |
| 26 | Sporran Ceremonial, long hair | Note (g) |
| 27 | Sword and accessories | Note (h) |
| 28 | Trade/skill qualification badge | Note (i) |

Notes:

- (a) Pipes and Drums wear a black belt fitted with the Australian Army Rising Sun Badge gold buckle or regimental badge, IAW regimental or battalion custom.
- (b) Officers and WO1. For Senior officers, IAW [Annex 5C](#).
- (c) Patent leather black boots or the issued R.M. Williams Elastic sided black leather boots may be worn when with ceremonial orders of dress (on parade).
- (d) Worn by Drum Major cymbal players and bass drummer.
- (e) Worn by Drum Major when performing with a marching band.
- (f) RA Inf WO2 and SNCO, and authorised members of the Corps of Staff Cadets and OCDTs.
- (g) Pipes and Drums are to wear Sporran Ceremonial, long hair.
- (h) Worn by designated personnel when on parade with armed troops. Worn by AABC officers and AABC WO1 performing the duties of Music Director. Worn by officers and WO1 when not wearing Claymore and cross belt.
- (i) Only worn by those qualified members, IAW [Annex 4O](#)

**Figure 5E-1: Dress Order No SD1A 'Scottish Ceremonial Parade Service Dress'
(Royal Stewart tartan Tartan shown)**



DRESS ORDER NO SD1B ‘SCOTTISH CEREMONIAL SERVICE DRESS’

35. This order of dress is worn by authorised personnel only and may be worn by spectators at ceremonial parades and other occasions when Scottish Ceremonial Dress is appropriate. It consists of the following items of dress.

Table 5E-3: Dress Order No SD1B ‘Scottish Ceremonial Service Dress’

| Serial | Item of Dress | Remarks |
|--------|---|---|
| 1 | Australian Army Rising Sun Badge embroidered on khaki background | |
| 2 | Badge AIRN | If qualified |
| 3 | Badge commendation or soldiers medallion | If awarded |
| 4 | Badge ACB/ICB/MIB/RIB | If presented/awarded |
| 5 | Belt black | Note (a) |
| 6 | Belt Sam Browne and shoulder strap | Note (b) |
| 7 | Bonnet Glengarry | Regimental or battalion custom pattern with appropriate hat badge |
| 8 | Claymore and cross belt | Pipers and drummers |
| 9 | Dirk | Optional, only worn by Pipe and/or Drum Major |
| 10 | Emblems of unit citation and/or awards | If awarded |
| 11 | Gaiters Highland with Patent leather black boots or R.M. Williams Elastic sided black leather boots | Note (c) |
| 12 | Garter/Regimental flashes | Regimental or battalion custom pattern |
| 13 | Gauntlets white | Note (d) |
| 14 | Hose-tops | Diced Australian tartan pattern, regimental or battalion custom pattern |
| 15 | Highland dress jacket modified cut-away | Line 40 Australian Army Rising Sun buttons |
| 16 | Kilt Australian, regimental or battalion tartan | Australian tartan pattern, regimental or battalion custom pattern |
| 17 | Lanyard, collar badges and insignia, ‘AUSTRALIA’ | |
| 18 | Nameplate | |
| 19 | Necktie khaki polyester | |
| 20 | Orders, decorations and medals | If awarded |
| 21 | Rank insignia | Officer rank to be pinned to epaulette |

| Serial | Item of Dress | Remarks |
|---------------|---------------------------------|---|
| 22 | Sash Drum Major | Note (e) |
| 23 | Sash Scarlet | Note (f) |
| 24 | Sgian-dubh, black | Optional, only worn by Pipe and/or Drum Major |
| 25 | Shirt polyester long sleeve | |
| 26 | Shirt khaki polyester | |
| 27 | Sporran Ceremonial, long hair | Note (g) |
| 28 | Trade/skill qualification badge | Note (h) |

Notes:

- (a) Pipes and Drums wear a black belt fitted with the Australian Army Rising Sun Badge gold buckle or regimental badge, IAW regimental or battalion custom.
- (b) Officers and WO1. For Senior officers, IAW [Annex 5C](#).
- (c) Patent leather black boots or the issued R.M. Williams elastic sided, black leather boots may be worn when with ceremonial orders of dress (on parade).
- (d) Worn by Drum Major cymbal players and bass drummer.
- (e) Worn by Drum Major when performing with a marching band.
- (f) RA Inf WO2 and SNCO, and authorised members of the Corps of Staff Cadets and OCDTs.
- (g) Pipes and Drums are to wear Sporran Ceremonial, long hair.
- (h) Only worn by those qualified members, IAW [Annex 4O](#).

**Figure 5E-2: Dress Order No SD1B 'Scottish Ceremonial Service Dress'
(Australian Tartan shown)**



DRESS ORDER NO SD1C ‘SCOTTISH GENERAL DUTY SERVICE DRESS’

36. This order of dress is worn by authorised personnel only and may be worn as an optional duty dress when ordered. It consists of the following items of dress:

Table 5E-4: Dress Order No SD1C ‘Scottish General Duty Service Dress’

| Serial | Item of Dress | Remarks |
|--------|--|---|
| 1 | Australian Army Rising Sun Badge embroidered on khaki background | |
| 2 | Badge AIRN | If qualified |
| 3 | Badge commendation or soldiers medallion | If awarded |
| 4 | Badge ACB/ICB/MIB/RIB | If presented/awarded |
| 5 | Belt black | Note (a) |
| 6 | Belt Sam Browne and shoulder strap | Note (b) |
| 7 | Bonnet Glengarry | Regimental or battalion custom pattern with appropriate hat badge |
| 8 | Emblems of unit citation and/or awards | If awarded |
| 9 | Garter/Regimental flashes | Regimental or battalion custom pattern |
| 10 | Highland dress jacket modified cut-away | Line 40 Australian Army Rising Sun buttons |
| 11 | Kilt Australian, regimental or battalion tartan | Australian tartan pattern, regimental or battalion custom pattern |
| 12 | Lanyard, collar badges and insignia, ‘AUSTRALIA’ | |
| 13 | Nameplate | |
| 14 | Necktie khaki polyester | |
| 15 | Rank insignia | Officer rank to be pinned to epaulette |
| 16 | Ribbon of orders, decorations and medals | If awarded |
| 17 | Shirt polyester long sleeve | |
| 18 | Shirt khaki polyester | |
| 19 | Shoes Highland, Gillie Brogues, black | |
| 20 | Stockings cream | |
| 21 | Sporran dress leather or imitation seal skin | |
| 22 | Trade/skill qualification badge | Note (c) |

Notes:

- (a) Pipes and Drums wear a black belt fitted with the Australian Army Rising Sun Badge gold buckle or regimental badge, IAW regimental or battalion custom.
- (b) ADJTs and RSMs are to wear the Sam Browne Belt, IAW [Chapter 3](#).
- (c) Only worn by those qualified members, IAW [Annex 4O](#).

Figure 5E-3: Dress Order No SD1C 'Scottish General Duty Service Dress' (Australian Tartan shown)



DRESS ORDER NO SD2A ‘SCOTTISH CEREMONIAL PARADE DRESS’

37. This order of dress is worn by authorised personnel only on Scottish ceremonial parades, including mounted parades, other than AFV parades, when the wearing of a jacket is not appropriate. It consists of the following items of dress:

Table 5E-5: Dress Order No SD2A ‘Scottish Ceremonial Parade Dress’

| Serial | Item of Dress | Remarks |
|--------|--|---|
| 1 | Australian Army Rising Sun Badge embroidered on khaki background | |
| 2 | Badge AIRN | If qualified |
| 3 | Badge commendation or soldiers medallion | If awarded |
| 4 | Badge ACB/ICB/MIB/RIB | If presented/awarded |
| 5 | Belt black | Note (a) |
| 6 | Belt Sam Browne and shoulder strap | Note (b) |
| 7 | Bonnet Glengarry | Regimental or battalion custom pattern with appropriate hat badge |
| 8 | Claymore and cross belt | Pipers and drummers |
| 9 | Dirk | Optional, only worn by Pipe and/or Drum Major |
| 10 | Emblems of unit citation and/or awards | If awarded |
| 11 | Gaiters Highland with Patent leather black boots or R.M. Williams elastic sided, black leather boots | Note (c) |
| 12 | Garter/Regimental flashes | Regimental or battalion custom pattern |
| 13 | Gauntlets white | Note (d) |
| 14 | Hose-tops | Diced Australian tartan pattern, regimental or battalion custom pattern |
| 15 | Kilt Australian, regimental or battalion tartan | Australian tartan pattern, regimental or battalion custom pattern |
| 16 | Lanyard and appropriate insignia shoulder | |
| 17 | Necktie khaki polyester | |
| 18 | Orders, decorations and medals | If awarded |
| 19 | Rank insignia | Officer rank to be pinned to shoulder boards |
| 20 | Sash Drum Major | Note (e) |
| 21 | Sash Scarlet | Note (f) |

| Serial | Item of Dress | Remarks |
|--------|---------------------------------|---|
| 22 | Sgian-dubh, black | Optional, only worn by Pipe and/or Drum Major |
| 23 | Shirt polyester short sleeve | |
| 24 | Shoulder boards khaki | Officer |
| 25 | Shirt khaki polyester | |
| 26 | Sporran Ceremonial, long hair | Note (g) |
| 27 | Sword and accessories | Note (h) |
| 28 | Trade/skill qualification badge | Note (i) |

Notes:

- (a) Pipes and Drums wear a black belt fitted with the Australian Army Rising Sun Badge gold buckle or regimental badge, IAW regimental or battalion custom.
- (b) Officers and WO1. For Senior officers, IAW [Annex 5C](#).
- (c) Patent leather black boots or the issued R.M. Williams Elastic sided black leather boots may be worn when with ceremonial orders of dress (on parade).
- (d) Worn by Drum Major cymbal players and bass drummer.
- (e) Worn by Drum Major when performing with a marching band.
- (f) RA Inf WO2 and SNCO, and authorised members of the Corps of Staff Cadets and OCDTs.
- (g) Pipes and Drums are to wear Sporran Ceremonial, long hair.
- (h) Worn by designated personnel when on parade with armed troops. Worn by AABC officers and AABC WO1 performing the duties of Music Director. Worn by officers and WO1 when not wearing Claymore and cross belt.
- (i) Only worn by those qualified members, IAW [Annex 4O](#).

**Figure 5E-4: Dress Order No SD2A 'Scottish Ceremonial Parade Dress'
(Australian Tartan shown)**



DRESS ORDER NO SD2B ‘SCOTTISH CEREMONIAL DRESS’

38. This order of dress is worn by authorised personnel only and may be worn by spectators at ceremonial parades and other occasions when Scottish Ceremonial Dress is appropriate. It consists of the following items of dress:

Table 5E-6: Dress Order No SD2B ‘Scottish Ceremonial Dress’

| Serial | Item of Dress | Remarks |
|--------|--|---|
| 1 | Australian Army Rising Sun Badge embroidered on khaki background | |
| 2 | Badge AIRN | If qualified |
| 3 | Badge commendation or soldiers medallion | If awarded |
| 4 | Badge ACB/ICB/MIB/RIB | If presented/awarded |
| 5 | Belt black | Note (a) |
| 6 | Belt Sam Browne and shoulder strap | Note (b) |
| 7 | Bonnet Glengarry | Regimental or battalion custom pattern with appropriate hat badge |
| 8 | Claymore and cross belt | Pipers and drummers |
| 9 | Dirk | Optional, only worn by Pipe and/or Drum Major |
| 10 | Emblems of unit citation and/or awards | If awarded |
| 11 | Gaiters Highland with Patent leather black boots or R.M. Williams elastic sided, black leather boots | Note (c) |
| 12 | Garter/Regimental flashes | Regimental or battalion custom pattern |
| 13 | Gauntlets white | Note (d) |
| 14 | Hose-tops | Diced Australian tartan pattern, regimental or battalion custom pattern |
| 15 | Kilt Australian, regimental or battalion tartan | Australian tartan pattern, regimental or battalion custom pattern |
| 16 | Lanyard and appropriate insignia shoulder | |
| 17 | Nameplate | |
| 18 | Necktie khaki polyester | |
| 19 | Orders, decorations and medals | If awarded |
| 20 | Rank insignia | Officer rank to be pinned to shoulder boards |
| 21 | Sash Drum Major | Note (e) |
| 22 | Sash Scarlet | Note (f) |

| Serial | Item of Dress | Remarks |
|--------|---------------------------------|---|
| 23 | Sgian-dubh, black | Optional, only worn by Pipe and/or Drum Major |
| 24 | Shirt polyester short sleeve | |
| 25 | Shoulder boards khaki | Officer |
| 26 | Shirt khaki polyester | |
| 27 | Sporran Ceremonial, long hair | Note (g) |
| 28 | Trade/skill qualification badge | Note (h) |

Notes:

- (a) Pipes and Drums wear a black belt fitted with the Australian Army Rising Sun Badge gold buckle or regimental badge, IAW regimental or battalion custom.
- (b) Officers and WO1. For Senior officers, IAW [Annex 5C](#).
- (c) Patent leather black boots or the issued R.M. Williams Elastic sided black leather boots may be worn when with ceremonial orders of dress.
- (d) Worn by Drum Major cymbal players and bass drummer.
- (e) Worn by Drum Major when performing with a marching band.
- (f) RA Inf WO2 and SNCO, and authorised members of the Corps of Staff Cadets and OCDTs.
- (g) Pipes and Drums are to wear Sporran Ceremonial, long hair.
- (h) Only worn by those qualified members, IAW [Annex 4O](#).

Figure 5E-5: Dress Order No SD2B 'Scottish Ceremonial Dress' (Royal Stewart Tartan shown)



DRESS ORDER NO SD2C ‘SCOTTISH GENERAL DUTY DRESS’

39. This order of dress is worn by authorised personnel only and may be worn as an optional duty dress when ordered. It consists of the following items of dress:

Table 5E-7: Dress Order No SD2C ‘Scottish General Duty Dress’

| Serial | Item of Dress | Remarks |
|--------|--|---|
| 1 | Australian Army Rising Sun Badge embroidered on khaki background | |
| 2 | Badge AIRN | If qualified |
| 3 | Badge commendation or soldiers medallion | If awarded |
| 4 | Badge ACB/ICB/MIB/RIB | If presented/awarded |
| 5 | Belt black | Note (a) |
| 6 | Belt Sam Browne and shoulder strap | Note (b) |
| 7 | Bonnet Glengarry | Regimental or battalion custom pattern with appropriate hat badge |
| 8 | Emblems of unit citation and/or awards | If awarded |
| 9 | Embroidered rank slides | Officer |
| 10 | Garter/Regimental flashes | Regimental or battalion custom pattern |
| 11 | Kilt Australian, regimental or battalion tartan | Australian tartan pattern, regimental or battalion custom pattern |
| 12 | Lanyard and appropriate insignia shoulder | |
| 13 | Nameplate | |
| 14 | Necktie khaki polyester | |
| 15 | Rank insignia | |
| 16 | Ribbon of orders, decorations and medals | If awarded |
| 17 | Shirt polyester short sleeve | |
| 18 | Shirt khaki polyester | |
| 19 | Shoes Highland, Gillie Brogues, black | |
| 20 | Stockings cream | |
| 21 | Sporran dress leather or imitation seal skin | |
| 22 | Trade/skill qualification badge | Note (c) |

Notes:

- (a) Pipes and Drums wear a black belt fitted with the Australian Army Rising Sun Badge gold buckle or regimental badge, IAW regimental or battalion custom.
- (b) ADJTs and RSMs are to wear the Sam Browne Belt, IAW [Chapter 3](#).

ADM

5E-22

(c) Only worn by those qualified members, IAW [Annex 4O](#).

Figure 5E-6: Dress Order No SD2C 'Scottish General Duty Dress' (Australian Tartan shown)



DRESS ORDER NO SD3 ‘SCOTTISH MESS DRESS’

40. This order of dress is worn by officers, WOs and SNCOs at mess functions, and by all members of Pipes and Drums, when in concert. It consists of the following items of dress:

Table 5E-8: Dress Order No SD3 ‘Scottish Mess Dress’

| Serial | Item of Dress | Remarks |
|--------|--|---|
| 1 | Australian Army Rising Sun Badge embroidered on black background | |
| 2 | Badge commendation or soldiers medallion–miniature | If awarded |
| 3 | Badge ACB/ICB–miniature | If presented/awarded |
| 4 | Badge metal FFI PJI/PJI/PJM–miniature | If presented/awarded |
| 5 | Badge metal aircrew–miniature | If presented |
| 6 | Bow tie black | |
| 7 | Chain jacket | Note (a) |
| 8 | Cummerbund Corps or non-Corps | Note (b) |
| 9 | Emblems of unit citation and/or awards–miniature | If awarded |
| 10 | Garter/Regimental flashes | Regimental or battalion custom pattern |
| 11 | Insignia shoulder, ‘AUSTRALIA’ | |
| 12 | Jacket black with collar badges | Line 30 Australian Army Rising Sun buttons ^{Note (c)} |
| 13 | Kilt Australian, regimental or battalion tartan | Australian tartan pattern, regimental or battalion custom pattern |
| 14 | Orders, decorations and medals–miniature | If awarded |
| 15 | Rank insignia | Officer and WO1 rank to be pinned to shoulder board |
| 16 | Sash scarlet | Note (d) |
| 17 | Shirt white Marcella front | Note (e) |
| 18 | Shoes Highland, Gillie Brogues, black | |
| 19 | Shoulder boards black curved | WO and SNCO embroidered |
| 20 | Stockings cream | |
| 21 | Sporran dress leather or imitation seal skin | |
| 22 | Trade/skill qualification badge | Note (f) |

Notes:

(a) Members are to wear either the silver or gold chain appropriate to Corps, IAW [Annex 50](#).

OFFICIAL

ADM

5E-24

- (b) Corps colours are in [Annex 5O](#).
- (c) All members are to wear the Australian Army Rising Sun Badge and full size qualification badges (if qualified) on the jacket. Jacket mess white may be worn in lieu, if Jacket black has not been issued.
- (d) Worn under the jacket by RA Inf WO2 and SNCO and authorised members of the Corps of Staff Cadets and OCDTs.
- (e) Members are to wear either the silver or gold studs appropriate to Corps, IAW [Annex 5O](#).
- (f) Only worn by those qualified members, IAW [Annex 4O](#).

AL5

OFFICIAL

**Figure 5E-7: Dress Order No SD3 'Scottish Mess Dress' (Black Jacket)
(Australian Tartan shown)**



Figure 5E-8: Dress Order No SD3 'Scottish Mess Dress' (White Jacket)
(Australian Tartan shown)



DRESS ORDER NO 4A 'GENERAL DUTY DRESS (AUSTRALIAN MULTI-CAM CAMOUFLAGE UNIFORM) PIPES AND DRUMS'

41. This order of dress is worn by authorised Pipes and Drums personnel only as dress of the day when performing band activities in the barracks environment; however, it is not to be worn when travelling in public including domestic civil aircraft. It consists of the following items of dress:

Table 5E-9: Dress Order No 4A 'General Duty Dress (Australian Multi-cam Camouflage Uniform) Pipes and Drums'

| Serial | Item of Dress | Remarks |
|--------|--|---|
| 1 | Australian Army Rising Sun Badge embroidered on AMCU background | |
| 2 | Boots combat | Note (a) |
| 3 | Bonnet Glengarry | Regimental or battalion custom pattern with appropriate hat badge |
| 4 | AMCU General Purpose jacket | AMCU rank slide |
| 5 | Shirt AMCU field | Notes (b) and (c) |
| 6 | Issued T-Shirt green, Army logo green T-shirt or purchased prescribed colour T-shirt | Note (d) |
| 7 | Name tag AMCU | |
| 8 | Rank insignia AMCU | |
| 9 | Sign ANF patch and USP/Trade qualification patch/identification arm patch | High visibility only ^{Note (e)} |
| 10 | Socks khaki | |
| 11 | Trousers AMCU | Note (f) |
| 12 | Wet weather ensemble | Optional |

Notes:

- (a) Boots Combat are to be worn, IAW [Chapter 3](#).
- (b) Sleeves are to be worn down and buttoned and/or fastened with velcro.
- (c) The shirt is to be worn outside the trousers. If the shirt is required to be tucked in, a pistol belt is to be worn, with the exception of recruits at training establishments who may, as required by the CO, wear black belts. Black belts may be ordered for training.
- (d) T-shirt green, Army Logo green T-shirt or purchased prescribed coloured T-shirt must be worn if the AMCU shirt is removed. The T-shirt green, Army logo green T-shirt or purchased prescribed coloured T-shirt is to be tucked in at all times, IAW [Chapter 3](#).
- (e) The ANF patch and USP/trade qualification patch/identification arm patch is to be worn, IAW [Chapter 3](#). The FSP is not worn with this order of dress.
- (f) Trousers are bloused over boots.

Figure 5E-1: Dress Order No 4A 'General Duty Dress (Disruptive Pattern Camouflage Uniform) Pipes and Drums' (8/9 Royal Australian Regiment Pipes and Drums shown)

TBI

DRESS ORDER NO SD5W 'SCOTTISH CEREMONIAL DRESS WHITE JACKET'

42. This order of dress is worn by authorised Pipes and Drums personnel when performing band duties in a mess environment or when a similar occasion is appropriate. This order of dress may also be worn when troops are on parade wearing Patrol Blue White Jacket; however, it is not worn when troops are on parade wearing other orders of ceremonial dress. It consists of the following items of dress:

Table 5E-10: Dress Order No SD5W 'Scottish Ceremonial Dress White Jacket'

| Serial | Item of Dress | Remarks |
|--------|--|---|
| 1 | Australian Army Rising Sun Badge embroidered on white background | |
| 2 | Badge AIRN | If qualified |
| 3 | Badge commendation or soldiers medallion | If awarded |
| 4 | Badge ACB/ICB/MIB/RIB | If presented/awarded |
| 5 | Belt black | Note (a) |
| 6 | Bonnet Glengarry | Regimental or battalion custom pattern with appropriate hat badge |
| 7 | Collar badges | |
| 8 | Claymore and cross belt | Pipers and drummers |
| 9 | Dirk | Optional, only worn by Pipe and/or Drum Major |
| 10 | Emblems of unit citation and/or awards | If awarded |
| 11 | Gaiters Highland with Patent leather black boots or R.M. Williams elastic sided, black leather boots | Note (b) |
| 12 | Garter/Regimental flashes | Regimental or battalion custom pattern |
| 13 | Gauntlets white | Note (c) |
| 14 | Hose-tops | Diced Australian tartan pattern, regimental or battalion custom pattern |
| 15 | Insignia shoulder, 'AUSTRALIA' | |
| 16 | Kilt Australian, regimental or battalion tartan | Australian tartan pattern, regimental or battalion custom pattern |
| 17 | Orders, decorations and medals | If awarded |

| Serial | Item of Dress | Remarks |
|--------|---------------------------------|--|
| 18 | Rank insignia | |
| 19 | Sash Drum Major | Note (e) |
| 20 | Sgian-dubh, black | Optional, only worn by Pipe and/or Drum Major |
| 21 | Shoulder boards, AABC pattern | |
| 22 | Sporran Ceremonial, long hair | Note (f) |
| 23 | Trade/skill qualification badge | Note (g) |
| 24 | White Jacket modified cut-away | Line 30 Australian Army Rising Sun buttons ^{Note (d)} |
| 25 | White T-shirt | |

Notes:

- (a) The Pipes and Drums wear a black belt fitted with Australian Army Rising Sun Badge silver buckle or regimental badge, IAW regimental or battalion custom.
- (b) Patent leather black boots or the issued R.M. Williams elastic sided, black leather boots may be worn when with ceremonial orders of dress.
- (c) Worn by the Drum Major, cymbal players and bass drummer.
- (d) All members are to wear full size qualification badges (if qualified) on the jacket.
- (e) Worn by Drum Major when performing with a marching band.
- (f) Pipes and Drums are to wear Sporran Ceremonial, long hair.
- (g) Only worn by those qualified members, IAW [Annex 40](#).

**Figure 5E-9: Dress Order No SD5W 'Scottish Ceremonial Dress White Jacket'
(8/9 Royal Australian Regiment Piper shown)**



DRESS ORDER NO SD5G ‘SCOTTISH CEREMONIAL DRESS GREEN JACKET’

43. This order of dress is worn by authorised Pipes and Drums personnel when performing band duties during civilian engagements; however, it is not worn when troops are conducting a unit parade. It consists of the following items of dress:

Table 5E-11: Dress Order No SD5G ‘Scottish Ceremonial Dress Green Jacket’

| Serial | Item of Dress | Remarks |
|--------|--|---|
| 1 | Australian Army Rising Sun Badge embroidered on white background | |
| 2 | Badge AIRN | If qualified |
| 3 | Badge commendation or soldiers medallion | If awarded |
| 4 | Badge ACB/ICB/MIB/RIB | If presented/awarded |
| 5 | Belt black | Note (a) |
| 6 | Bonnet Feather | Fitted with appropriate regimental accoutrements and hat badge |
| 7 | Collar badges | |
| 8 | Claymore and cross belt | Pipers and drummers |
| 9 | Dirk | Optional, only worn by Pipe and/or Drum Major |
| 10 | Emblems of unit citation and/or awards | If awarded |
| 11 | Gaiters Highland with Patent leather black boots or R.M. Williams elastic sided, black leather boots | Note (b) |
| 12 | Garter/Regimental flashes | Regimental or battalion custom pattern |
| 13 | Gauntlets white | Note (c) |
| 14 | Green Jacket modified cut-away | Line 30 Australian Army Rising Sun buttons ^{Note (d)} |
| 15 | Hose-tops | Diced Australian tartan pattern, regimental or battalion custom pattern |
| 16 | Insignia shoulder, ‘AUSTRALIA’ | |
| 17 | Kilt Australian, regimental or battalion tartan | Australian tartan pattern, regimental or battalion custom pattern |
| 18 | Orders, decorations and medals | If awarded |
| 19 | Pipe Major Association ‘rank’ insignia | Optional, only worn by Pipe and/or Drum Major |
| 20 | Plaid with Australian Army Rising Sun Badge or regimental badge | Note (e) |

| Serial | Item of Dress | Remarks |
|--------|---------------------------------|---|
| 21 | Rank insignia | |
| 22 | Sash Drum Major | Note (f) |
| 23 | Sgian-dubh, black | Optional, only worn by Pipe and/or Drum Major |
| 24 | Shoulder boards, AABC pattern | |
| 25 | Sporran Ceremonial, long hair | Note (g) |
| 26 | Trade/skill qualification badge | Note (h) |

Notes:

- (a) The Pipes and Drums wear a black belt fitted with Australian Army Rising Sun Badge silver buckle or regimental badge, IAW regimental or battalion custom.
- (b) Patent leather black boots or the issued R.M. Williams elastic sided, black leather boots may be worn when with ceremonial orders of dress.
- (c) Worn by the Drum Major, cymbal players and bass drummer.
- (d) All members are to wear full size qualification badges (if qualified) on the jacket.
- (e) Worn by Pipe Major and Drum Major.
- (f) Worn by Drum Major when performing with a marching band.
- (g) Pipes and Drums are to wear Sporran Ceremonial, long hair.
- (h) Only worn by those qualified members, IAW [Annex 4O](#).

**Figure 5E-10: Dress Order No SD5G 'Scottish Ceremonial Dress Green Jacket'
(8/9 Royal Australian Regiment Drum Major shown)**



CHAPLAIN DRESS

DRESS EMBELLISHMENTS

1. Chaplains are to wear either a gold metal cross, Christian or Star of David–Jewish, in Figure 5F–1 on all Australian Army uniforms, except AMCU, the insignia is to be embroidered black on AMCU background, as shown in Figure 5F–2. The positioning of the insignia is in a line bisecting the point of the shirt collar, with the lowest point of the insignia 1 cm from the point of the collar or on the rank slide. Metal insignia is positioned on jackets in the same manner as Corps/Regiment collar badges, in accordance with (IAW) [Annex 4D](#). With Mess Dress, the insignia is positioned in the same manner as Corps/Regiment badges, IAW [Annex 4D](#) and [Annex 5Q](#). With open neck shirts and jackets, the insignia is positioned on the line bisecting the point of the shirt collar, with the lowest point of the insignia 1 cm from the point of the collar, as shown in Figure 5F–3. When the insignia is sewn on shirt collars, they are to be in the same position and alignment as the metal insignia on shirts, Service Dress jacket and Ceremonial Safari Suit jacket.

Figure 5F–1: Metal Christian cross and Star of David–Jewish badges



ECCLESIASTICAL DRESS

4. For conduct of worship or other liturgical ceremonial occasions, Christian Chaplains are to wear over a prescribed Army order of dress, the robes of the denominational stream to which they belong, ie Anglican, Roman Catholic, Protestant and other Denominations. The prescribed order of dress is to be consistent with that worn by other participants in the ceremony or service. On ceremonial occasions, chaplains may wear medals on the scarf or stole.
5. When chaplains are attending ceremonial occasions and are not officiating, and therefore, not robed, they may wear the Sam Browne Belt with ceremonial orders of dress.
6. Clerical collars with a black stock may be worn instead of the polyester shirt and tie with Service dress orders of dress, Utility jacket or the white shirt and bow tie with mess dress orders of dress.

ARMY EMERGENCY RESPONSE DRESS

GENERAL

1. Army Emergency Response (AER) personnel are required to respond to immediately emergencies. They must be dressed in protective equipment which is determined by the Senior AER member.
2. The AER Badge is issued to provide ready identification of AER personnel at emergency sites. The logo provides identification for members not currently qualified to wear the AER trade qualification badge. It is a legislative requirement for AER personnel to be identifiable to Commonwealth, State and military emergency services at all emergency sites. This identification is provided by the AER Badge worn on a brassard on the right sleeve or fire fighters' helmet, in accordance with (IAW) Figure 5G-1.

Figure 5G-1: Army Emergency Response Badge



3. When engaged on AER duties outside military areas, AER Working/Protective Dress is to be worn. While on AER duty within barracks, AER Working Dress is to be worn as a barrack dress.

ORDERS OF DRESS

4. The special orders of dress for AER personnel are in Table 5G-1.

Table 5G-1: Orders of Dress

| Dress Number | Dress Order Title | Table |
|--------------|--------------------------------------|-------|
| ER1 | Emergency Response Working Dress | 5G-2 |
| ER2 | Emergency Response Emergency Dress 1 | 5G-3 |
| ER3 | Emergency Response Emergency Dress 2 | 5G-4 |

DRESS ORDER NO ER1 ‘EMERGENCY RESPONSE WORKING DRESS’

5. This order of dress is worn by AER personnel while on AER duty in both barracks and in the field. This order of dress is not to be worn on non-trade related promotion courses. It consists of the following items of dress:

Table 5G-2: Dress Order No ER1 ‘Emergency Response Working Dress’

| Serial | Item of Dress | Remarks |
|--------|--|---|
| 1 | Australian Army Rising Sun Badge embroidered on AMCU background | |
| 2 | Badge identification AER | Note (a) |
| 3 | Beret Corps/Regiment/Unit with appropriate hat badge | Note (b) |
| 4 | Boots fire fighter/Boots combat | Note (c) |
| 5 | General Purpose Jacket | Optional but with AMCU rank slide |
| 6 | Hat KFF with UCP with appropriate hat badge or field hat | Note (d) Brim down |
| 7 | Issued T-Shirt green, Army logo green T-shirt or purchased prescribed colour T-shirt | Note (e) |
| 8 | Shirt AMCU field | Note (f) and (g) |
| 9 | Name Tag AMCU | |
| 10 | Rank insignia AMCU | |
| 11 | Sign ANF patch and USP/Trade qualification patch/Identification arm patch | High visibility only Note (f) and (g) |
| 12 | Socks khaki | High visibility only. Note (h) and (i) |
| 13 | Trousers over garment with suspenders | Note (j) |
| 14 | Trousers AMCU | |

Notes:

- (a) To be worn at all times during AER operational activities
- (b) Berets are to be worn, IAW [Chapter 3](#).

ADM

5G–3

- (c) Boots fire fighter is provided as protective equipment and is only to worn during AER operational activities. Boots combat is to be worn outside these periods IAW [Chapter 3](#).
- (d) Hat KFF is worn with puggaree, including approved UCP, IAW [Chapter 3](#), chin strap and Corps hat badge only. The brim is to be turned down.
- (e) T-shirt green, Army Logo green T-shirt or purchased prescribed coloured T-shirt must be worn if the AMCU shirt is removed. The T-shirt green, Army logo green T-shirt or purchased prescribed coloured T-shirt is to be tucked in at all times, IAW [Chapter 3](#).
- (f) Sleeves are to be worn down and buttoned and/or fastened with Velcro. They are not to cut off, rolled-up or folded.
- (g) The shirt is to be worn outside the trousers. If the shirt is required to be tucked in, a pistol belt is to be worn.
- (h) The ANF patch and USP/Trade qualification patch/Identification arm patch is to be worn IAW [Chapter 3](#). The FSP is not worn with this order of dress.
- (i) Only worn by those qualified members, IAW [Annex 4O](#).
- (j) May be worn as directed by the Senior AER, IAW AER operating procedures to enable a rapid response.

Figure 5G–2: Dress Order No ER1 ‘Emergency Response Working Dress’

TBA

DRESS ORDER NO ER2 ‘EMERGENCY RESPONSE EMERGENCY DRESS’

6. This order of dress is worn by AER personnel while on emergency AER duty. It consists of the following items of dress:

Table 5G–3: Dress Order No ER2 ‘Emergency Response Emergency Dress’

| Serial | Item of Dress | Remarks |
|--------|--|---|
| 1 | Australian Army Rising Sun Badge embroidered on AMCU background | |
| 2 | Badge identification AER | Note (a) |
| 3 | Boots Fireman’s | Note (b) |
| 4 | Coat Fireman’s Structural | Note (c) |
| 5 | Gloves Fireman’s Structural | |
| 6 | Helmet Fireman’s Structural | Badge helmet AER and name tag affixed to helmet. Notes (d) and (e) |
| 7 | Hood Firefighter | |
| 8 | Issued T-Shirt green, Army logo green T-shirt or purchased prescribed colour T-shirt | Note (f) |
| 9 | Shirt AMCU Field | Notes (g), (h) and (i) |

| Serial | Item of Dress | Remarks |
|--------|---|--|
| 10 | Name Tag AMCU | |
| 11 | Rank insignia AMCU | |
| 12 | Socks khaki | |
| 13 | Sign ANF patch and USP/Trade qualification patch/Identification arm patch | High visibility only. Notes (j) and (k) |
| 14 | Trousers AMCU | |
| 15 | Trousers Fireman's Structural | |
| 16 | Vest high visibility | Note (l) |

Notes:

- (a) To be worn at all times during AER operational activities.
- (b) Boots fireman's are provided as protective equipment and are only to worn during AER operational activities. Boots combat is to be worn outside these periods IAW [Chapter 3](#).
- (c) No rank insignia or badges of any kind are to worn on this garment.
- (d) May be removed at incident scenes, as directed by the Senior AER member, IAW AER operating procedures.
- (e) Not to be worn whilst riding in a vehicle.
- (f) T-shirt green, Army Logo green T-shirt or purchased prescribed coloured T-shirt must be worn if the AMCU shirt is removed. The T-shirt green, Army logo green T-shirt or purchased prescribed coloured T-shirt is to be tucked in at all times, IAW [Chapter 3](#).
- (g) Sleeves are to be worn down and buttoned and/or fastened with Velcro. They are not to cut off, rolled-up or folded.
- (h) The shirt is to be worn outside the trousers. If the shirt is required to be tucked in, a pistol belt is to be worn.
- (i) May be removed whilst wearing Coat Fireman's.
- (j) The ANF patch and USP/Trade qualification patch/Identification arm patch is to be worn IAW [Chapter 3](#). The FSP is not worn with this order of dress.
- (k) Only worn by those qualified members, IAW [Annex 4O](#).
- (l) As directed by the senior AER member, IAW AER operating procedures.

Figure 5G-3: Dress Order No ER2 'Emergency Response Emergency Dress'



DRESS ORDER NO ER3 'EMERGENCY RESPONSE EMERGENCY DRESS'

7. This order of dress is worn by AER personnel while on emergency AER duty. It consists of the following items of dress:

Table 5G-4: Dress Order No ER3 'Emergency Response Emergency Dress'

| Serial | Item of Dress | Remarks |
|--------|---|---------|
| 1 | Australian Army Rising Sun Badge embroidered on AMCU background | |

| Serial | Item of Dress | Remarks |
|--------|--|--|
| 2 | Badge identification AER | Note (a) |
| 3 | Boots Fireman's | Note (b) |
| 4 | Coat Fireman's Wildfire | Note (c) |
| 5 | Gloves Fireman's Wildfire | |
| 6 | Helmet, Fireman's Wildfire | Badge helmet AER and name tag affixed to helmet. Notes (d) and (e) |
| 7 | Issued T-Shirt green, Army logo green T-shirt or purchased prescribed colour T-shirt | Note (f) |
| 8 | Shirt AMCU Field | Note (g),(h) and (i) |
| 9 | Name Tag AMCU | |
| 10 | Rank insignia AMCU | |
| 11 | Socks khaki | |
| 12 | Sign ANF patch and USP/Trade qualification patch/Identification arm patch | High visibility only. Note (j) and (k) |
| 13 | Trousers AMCU | |
| 14 | Trousers Fireman's Wildfire | |

Notes:

- (a) To be worn at all times during AER operational activities.
- (b) Boots fireman's are provided as protective equipment and are only to worn during AER operational activities. Boots combat is to be worn outside these periods IAW [Chapter 3](#).
- (c) No rank insignia or badges of any kind are to worn on this garment.
- (d) May be removed at incident scenes, as directed by the senior AER member, IAW AER operating procedures.
- (e) Not to be worn whilst riding in a vehicle.
- (f) T-shirt green, Army Logo green T-shirt or purchased prescribed coloured T-shirt must be worn if the AMCU shirt is removed. The T-shirt green, Army logo green T-shirt or purchased prescribed coloured T-shirt is to be tucked in at all times, IAW [Chapter 3](#).
- (g) Sleeves are to be worn down and buttoned and/or fastened with Velcro. They are not to cut off, rolled-up or folded.
- (h) The shirt is to be worn outside the trousers. If the shirt is required to be tucked in, a pistol belt is to be worn.
- (i) May be removed whilst wearing Coat Fireman's.
- (j) The ANF patch and USP/Trade qualification patch/Identification arm patch is to be worn IAW [Chapter 3](#). The FSP is not worn with this order of dress.
- (k) Only worn by those qualified members, IAW [Annex 4O](#).
- (l) As directed by the senior AER member, IAW AER operating procedures.

Figure 5G-4: Dress Order No ER3 'Emergency Response Emergency Dress'



MILITARY EQUESTRIAN DRESS

GENERAL

1. The wearing of Military Equestrian Dress by members of the Army maintains the tradition of the Australian Light Horse. This tradition is fostered by Heritage Troops sponsored by RAAC units, riders of equine mascots and soldiers participating in equestrian sports. It is essential that high standards of dress and appearance, and historical authenticity are maintained by these members on ceremonial parades and other formal occasions.

RESPONSIBILITY FOR PROVISION OF TECHNICAL ADVICE

2. The Committee of the Australian Army Equestrian Association (AAEA) is responsible to provide AHQ advice on historic and technical aspects of equestrian uniforms and equipment.

WEARING OF MILITARY EQUESTRIAN UNIFORM

3. A CO may authorise a member to wear Equestrian Dress for unit ceremonial parades or other appropriate occasions. The Committee of the AAEA may authorise a member to wear Military Equestrian Dress when representing the Army in equestrian sports.

SADDLECLOTHS AND EQUIPMENT

Saddlecloth

4. The Army saddlecloth colours are red with white trim. The Australian Army Rising Sun Badge is to be mounted on the lower rear panels of the saddlecloth. The Army saddlecloth is to be used on all occasions, unless otherwise authorised by the Committee of the AAEA.

Heritage colours

5. Units with approved heritage saddlecloth colours may display these on single unit ceremonial parades which do not include other Corps or Services. If parades do include representatives of other Corps or Services, the Army saddlecloth is to be used.

Equipment

6. Other items of equipment, such as horse show rugs are to incorporate the Australian Army colours and the Australian Army Rising Sun Badge.

ENTITLEMENT

7. Members who wear Military Equestrian Dress do not have an entitlement for this order of dress and are not to be issued with items of dress, such as breeches. All items of Military Equestrian Dress are to be purchased at the members' expense.

ORDERS OF DRESS

8. This order of dress to be worn is determined by the nature of the activity. Certain items of dress are essential to conform to agreed international equestrian protocols. The orders of Military Equestrian Dress are in Table 5H-1.

Table 5H-1: Orders of Dress

| Dress Number | Dress Order Title | Table |
|---------------------|--------------------------------------|--------------|
| ME1A | Ceremonial Equestrian Dress | 5H-2 |
| ME1B | Ceremonial Equestrian Service Dress | 5H-3 |
| ME2 | General Duty Equestrian Dress | 5H-4 |
| ME3 | Heritage Light Horse Dress (1915-18) | 5H-5 |

DRESS ORDER NO ME1A 'CEREMONIAL EQUESTRIAN DRESS'

9. Ceremonial Equestrian Dress is to be worn by riders of equine mascots, members mounted on horseback, other than Heritage Troops on ceremonial parades and other occasions when Ceremonial Dress is ordered. It consists of the following items of dress:

Table 5H-2: Dress Order No ME1A 'Ceremonial Equestrian Dress'

| Serial | Item of Dress | Remarks |
|---------------|--|---|
| 1 | Australian Army Rising Sun Badge embroidered on khaki background | |
| 2 | Badge AIRN | If qualified |
| 3 | Badge commendation or soldiers medallion | If awarded |
| 4 | Badge ACB/ICB/MIB/RIB | If presented/awarded |
| 5 | Belt black and belt hooks | |
| 6 | Belt Sam Browne, shoulder strap and belt hooks | Note (a) |
| 7 | Boards shoulder khaki | Officer and OCDT/SCDT |
| 8 | Breeches fawn | |
| 9 | Emblems of unit citation and/or awards | If awarded |
| 10 | Gloves leather | |
| 11 | Hat KFF with appropriate hat badge | Worn with emu plumes and brim worn up ^{Note (c)} |
| 12 | Lanyard and appropriate insignia shoulder | |

| Serial | Item of Dress | Remarks |
|--------|---------------------------------|---|
| 13 | Orders, decorations and medals | If awarded |
| 14 | Rank insignia | Officer rank to be pinned to board shoulder khaki |
| 15 | Sash scarlet | Note (d) |
| 16 | Shirt polyester short sleeved | |
| 17 | Socks khaki | |
| 18 | Spurs Prince of Wales | As directed |
| 19 | Top boots black | High gloss only |
| 20 | Trade/skill qualification badge | Note (e) |

Notes:

- (a) Officers and WO1. For Senior officers, in accordance with (IAW) [Annex 5C](#).
- (b) Hat KFF may be replaced by an Australian Standard approved safety helmet. To conform to equestrian discipline regulations, this helmet is to be covered in Service Dress material. A Corps/Regiment badge is to be fixed centrally to the front of the helmet.
- (c) RA Inf WO2 and SNCO, and authorised members of the Corps of Staff Cadets and OCDTs.
- (d) Only worn by those qualified members, IAW [Annex 4O](#).

Figure 5H-1: TBI

TBI

DRESS ORDER NO ME1B 'CEREMONIAL EQUESTRIAN SERVICE DRESS'

10. Ceremonial Equestrian Service Dress is to be worn by riders of equine mascots, members mounted on horseback, other than Heritage Troops on ceremonial parades and other occasions when ceremonial dress is ordered. It consists of the following items of dress:

Table 5H-3: Dress Order No ME1B 'Ceremonial Equestrian Service Dress'

| Serial | Item of Dress | Remarks |
|--------|--|-----------------------|
| 1 | Australian Army Rising Sun Badge embroidered on khaki background | |
| 2 | Badge AIRN | If qualified |
| 3 | Badge commendation or soldiers medallion | If awarded |
| 4 | Badge ACB/ICB/MIB/RIB | If presented/awarded |
| 5 | Belt black | |
| 6 | Belt Sam Browne and shoulder strap | Note (a) |
| 7 | Boards shoulder khaki | Officer and OCDT/SCDT |
| 8 | Breeches fawn | |
| 9 | Emblems of unit citation and/or awards | If awarded |

| Serial | Item of Dress | Remarks |
|--------|---|---|
| 10 | Emblems of unit awards and individual commendations | |
| 11 | Gloves leather | |
| 12 | Hat KFF with appropriate hat badge | Worn with emu plumes and brim worn up ^{Note (c)} |
| 13 | Jacket Service dress | Line 30 Australian Army Rising Sun buttons |
| 14 | Lanyard, collar badges and insignia shoulder, 'AUSTRALIA' | |
| 15 | Necktie khaki polyester | |
| 16 | Orders, decorations and medals | If awarded |
| 17 | Rank insignia | Officer rank to be pinned to epaulette |
| 18 | Sash scarlet | Note (d) |
| 19 | Shirt polyester long sleeve | |
| 20 | Socks khaki | |
| 21 | Spurs Prince of Wales | As directed |
| 22 | Top boots black | High gloss only |
| 23 | Trade/skill qualification badge | Note (e) |

Notes:

- (a) Officers and WO1. For Senior officers, IAW [Annex 5C](#).
- (b) Hat KFF may be replaced by an Australian Standard approved safety helmet. To conform to equestrian discipline regulations this helmet is to be covered in Service Dress material. A Corps/Regiment badge is to be fixed centrally to the front of the helmet.
- (c) RA Inf WO2 and SNCO, and authorised members of the Corps of Staff Cadets and OCDTs.
- (d) Only worn by those qualified members, IAW [Annex 4O](#).

Figure 5H-2: TBI

TBI

DRESS ORDER NO ME2 ‘GENERAL DUTY EQUESTRIAN DRESS’

11. This is an order of dress which may be worn as an optional general duty dress at the discretion of individuals. It consists of the following items of dress:

Table 5H-4: Dress Order No ME2 ‘General Duty Equestrian Dress’

| Serial | Item of Dress | Remarks |
|--------|--|--|
| 1 | Australian Army Rising Sun Badge embroidered on khaki background | |
| 2 | Badge AIRN | If qualified |
| 3 | Badge commendation or soldiers medallion | If awarded |
| 4 | Badge ACB/ICB/MIB/RIB | If presented/awarded |
| 5 | Belt khaki 32 mm | |
| 6 | Belt Sam Browne, shoulder strap and belt hooks | Note (a) |
| 7 | Beret Corps/Regiment/Unit with appropriate hat badge | Note (b) |
| 8 | Breeches fawn | |
| 9 | Emblems of unit citation and/or awards | If awarded |
| 10 | Gloves leather | |
| 11 | Hat KFF with appropriate hat badge | Worn with emu plumes brim down Note (c) |
| 12 | Lanyard and appropriate insignia shoulder | |
| 13 | Nameplate | |
| 14 | Rank insignia | |
| 15 | Ribbons of orders, decorations and medals | |
| 16 | Shirt short sleeve polyester | |
| 17 | Socks khaki | |
| 18 | Spurs Prince of Wales | As directed |
| 19 | Trade/skill qualification badge | Note (d) |
| 20 | Top boots black | May be brush polished |

Notes:

- (a) ADJTs and RSMs are to wear the Sam Browne Belt, IAW [Chapter 3](#).
- (b) Berets are to be worn, IAW [Chapter 3](#).
- (c) Hat KFF may be replaced by an Australian Standard approved safety helmet. To conform to equestrian discipline regulations this helmet is to be covered in Service Dress material. A Corps/Regiment badge is to be fixed centrally to the front of the helmet.
- (d) Only worn by those qualified members, IAW [Annex 4O](#).

Figure 5H-3: TBI

TBI

DRESS ORDER NO ME3 'HERITAGE LIGHT HORSE DRESS' (1915-18)

12. Heritage Light Horse Dress (1915-18) is worn by riders engaged in field exercises or training activities. This order of dress is to be worn by members, mounted on horseback representing Light Horse troops on ceremonial parades, displays and other occasions when ceremonial dress is ordered Note (a). When this order of dress is worn, it is essential to ensure that historical accuracy is maintained. It consists of the following items of dress:

Table 5H-5: Dress Order No ME3 'Heritage Light Horse Dress' (1915-18)

| Serial | Item of Dress | Remarks |
|--------|---|--|
| 1 | Australian Army Rising Sun Badge – Badge General Duty (Black/Brass) | |
| 2 | Bandolier brown/tan – 1903 pattern | |
| 3 | Breeches khaki – Bedford cord | |
| 4 | Boots, leather brown, cap less toe, lace up ankle boot | High gloss only |
| 5 | Hat KFF with appropriate hat badge | Worn with emu plumes brim up for ceremonial and brim down for training |
| 6 | Insignia shoulder, 'AUSTRALIA' (Black/Brass) | |
| 7 | Leggings leather brown – Stowasser pattern | |
| 8 | Orders, decorations and medals | If awarded |
| 9 | Rank insignia | Note (b) |
| 10 | Regimental/Unit Colour Patch | Worn on both shoulders, 3 cm below the epaulette |
| 11 | Socks khaki | |
| 12 | Spurs Prince of Wales | |
| 13 | Tunic Service light drab – 1912 pattern | Buttons brown flat – cellulose/celluloid |
| 14 | Waist belt leather brown – 1903 pattern 1¾ inch | Note (c) |

Notes:

- (a) A civilian Heritage Troop does not need to comply with this order of dress. This order of dress applies to unit serving members wearing Heritage Light Horse Dress (1915-18) at official functions, events and ceremonies.
- (b) To preserve authenticity, rank insignia is not to be worn, irrespective of the participating ranks. If a Heritage Troop parades as a troop, one member acting as Troop SGT is to wear the appropriate rank insignia.
- (c) Light Horse pattern ammunition pouches (10 or 15 rounds) may be worn on the belt, if required.

Figure 5H-4: Dress Order No ME3 'Heritage Light Horse Dress' (1915-18)



AUSTRALIAN DEFENCE FORCE ACADEMY DRESS

AUTHORITY FOR WEARING

1. ADFA Dress is to be worn by members posted to ADFA as instructional staff and OCDTs.

PROVISIONS OF AUSTRALIAN DEFENCE FORCE ACADEMY DRESS

2. ADFA orders of dress are approved for issue to authorised ADFA staff and OCDTs. The provision for ADFA dress is at Block Scale 3002/27.

WEARING OF AUSTRALIAN DEFENCE FORCE ACADEMY ITEMS OF DRESS

3. ADFA orders of dress are to be worn during ceremonial and mess occasions.

Blue Service cap

4. The Regimental Sergeant Major Officer Training College (RSM OTC) and Band Master are authorised to wear the Blue Service cap as dress of the day with ceremonial orders of dress and General Duty Dress (polyesters). All Army members on parade, when wearing Patrol Blue White Jacket, are authorised to wear the Blue Service cap.

Boots

5. Baxter patent leather black boots with plates are to be worn by the Academy Sergeant Major (ASM), ADJT, RSM OTC and Band Master with General Duty Dress (polyesters), General Duty Service Dress, ceremonial and mess dress orders of dress. OCDTs are to wear Baxter patent leather black boots without plates fitted when wearing ceremonial orders of dress. The issued R.M. Williams elastic sided, black leather boots are authorised to be worn with General Duty Dress (polyesters), General Duty Service Dress, ceremonial and mess dress orders of dress, when ordered.

Buttons

6. Line 30 Australian Army Rising Sun buttons are worn on the Patrol Blue White Jacket and by OCDTs when wearing Mess Dress White Jacket.

Cap badge

7. The miniature sized Australian Army Rising Sun Badge is to be worn on the Blue Service cap by OCDTs and the Corps badge is worn by authorised ADFA staff, with the respective badge placed centrally on the front of the cap, and the base of the badge positioned 1 cm above the top of the chin strap. The position of the badge is in accordance with (IAW) [Chapter 3](#), [Chapter 4](#) and [Annex 4D](#).

Collar badges

8. Australian Army Rising Sun Collar Badges are worn by OCDTs and Corps collar badges are worn by authorised ADFA staff with the Patrol Blue White Jacket, IAW [Annex 4D](#) and mess dress orders of dress, IAW [Annex 5O](#).

Court shoes

9. Black Court shoes may be worn when wearing skirts. They may also be worn with slacks and trousers except Ceremonial Parade Dress, IAW [Chapter 3](#).

General Duty Dress (polyesters)

10. ADFA staff and OCDTs are to wear General Duty Dress (polyesters) as dress of the day.

Gold chain

11. The Gold chain is to be worn on the Mess Dress White Jacket, when worn by OCDTs and with Mess Dress Army. The chain is worn attached to the back of the inside front line 30 Australian Army Rising Sun buttons, IAW [Annex 5O](#). The chain is to be secured inside jacket, level with the top row of line 30 Australian Army Rising Sun buttons.

Pace stick

12. The pace stick is carried by the RSM OTC with all orders of dress, except field and mess dress orders of dress. RSM OTC is to carry the pace stick, IAW [Chapter 3](#).

Patrol Blue White Jacket

13. The Patrol Blue White Jacket is authorised to be worn on ceremonial parades by the following members:

- a. ASM
- b. ADJT
- c. RSM OTC
- d. Band Master
- e. Staff members of the ADFA Band
- f. ADFA OCDTs.

Rank slides for Disruptive Pattern Camouflage Uniform/Protective Dress

14. Cadets are to wear AMCU rank slides with a 10 mm white stripe positioned 20 mm from the lower edge of the slide, as shown in Figure 5I-1.

Figure 5I-1: Rank slide for Australian Multi-cam Camouflage Uniform/Protective Dress

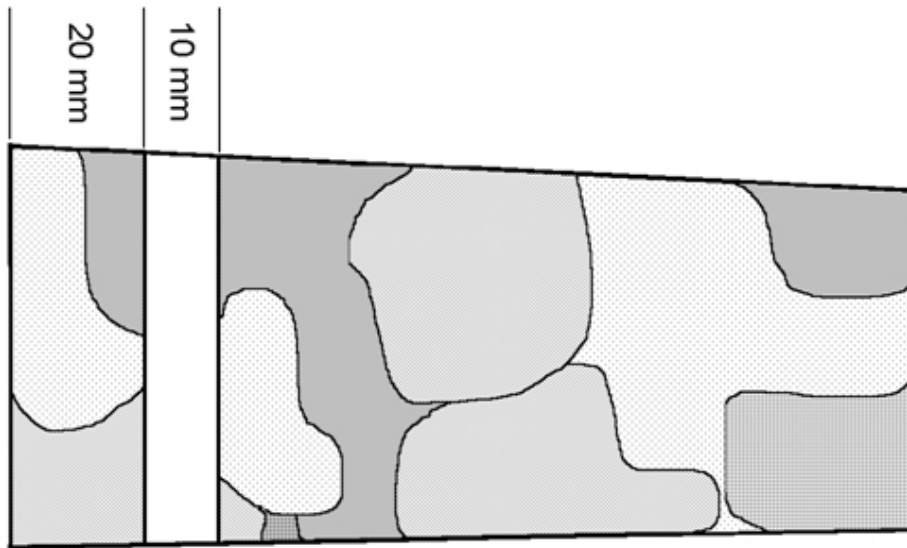

Shoulder boards

15. OCDTs are to wear khaki shoulder boards with polyester ceremonial orders of dress but without rank affixed.

Shoulder slides

16. OCDTs are to wear khaki shoulder slides with General Duty Dress (polyesters) with the embroidered 'AUSTRALIA' titles and a 10 mm white stripe which is positioned 20 mm from the lower edge of the slide.

Shoulder titles

17. The 'AUSTRALIA' shoulder titles are to be worn on khaki shoulder boards when worn with polyester ceremonial orders of dress, shoulder boards black with scarlet bordering when worn with Patrol Blue White Jacket and on Mess Dress White Jacket. The 'AUSTRALIA' shoulder titles are to be positioned IAW [Chapter 3](#).

Skirts

18. Skirts are an optional alternative to trousers in ceremonial and general duty orders of dress, except Ceremonial Parade Dress. When worn with Mess Dress, the bottom of the skirt is to touch the toe of the black Court shoes, IAW [Chapter 3](#) and [Annex 5O](#).

19. Pantihose or stockings are optional with General Duty Dress (polyesters); and ceremonial orders of dress. If they are not worn with General Duty Dress (polyesters) or ceremonial orders of dress, footlets are to be worn with the issued footwear. Pantihose, stockings and footlets must be plain and in matching flesh tones, when worn with ceremonial and general duty orders of dress. Stockings or pantihose when worn with Mess Dress is to be plain black.

Socks khaki

20. Socks khaki are to be worn with boots and shoes when wearing trousers, IAW [Chapter 3](#).

Swagger Stick

21. The Swagger stick is authorised to be carried by the ADJT ADFA but only when the ADJT position is filled by an Army officer. The Swagger stick is not a Block Scale item and is to be purchased at the unit's expense. The Swagger stick is to be carried in the same manner as the cane.

Trousers and slacks

22. Trousers and slacks are to be worn by all members when side arms are carried. The front of the cuff or hem of the trousers and slacks is IAW [Chapter 3](#).

White web belt

23. The white web belt is worn with Patrol Blue White Jacket. The belt alignment is IAW [Chapter 3](#).

ORDERS OF DRESS

24. The ADFA orders of dress are in Table 5I-1.

Table 5I-1: Orders of Dress

| Dress Number | Dress Order Title | Table |
|--------------|---------------------------|-------|
| ADFA 1 | Patrol Blue White Jacket | 5I-2 |
| ADFA 2 | Mess Dress White Jacket | 5I-3 |
| ADFA 3 | Scottish Ceremonial Dress | 5I-4 |
| ADFA 4 | Scottish Mess Dress | 5I-5 |

DRESS ORDER NO ADFA 1 'PATROL BLUE WHITE JACKET'

25. This order of dress is worn by authorised ADFA personnel on ceremonial parades and other occasions when the wearing of the jacket is appropriate. It consists of the following items of dress:

Table 5I-2: Dress Order No ADFA 1 'Patrol Blue White Jacket'

| Serial | Items of Dress | Remarks |
|--------|---|--------------|
| 1 | Aiguillette | Note (a) |
| 2 | Australian Army Rising Sun Badge embroidered Gold and Red on white background | |
| 3 | Badge AIRN | If qualified |

| Serial | Items of Dress | Remarks |
|--------|---|--|
| 4 | Badge commendation or soldiers medallion | If awarded |
| 5 | Badge ACB/ICB/MIB/RIB | If presented/awarded |
| 6 | Belt hooks | Note (b) |
| 7 | Belt web white | Note (c) |
| 8 | Blue Service cap with Australian Army Rising Sun Badge–miniature | Line 20 Australian Army Rising Sun buttons |
| 9 | Collar badges, Australian Army Rising Sun–miniature | Note (d) |
| 10 | Emblems of unit citation and/or awards | If awarded |
| 11 | Gloves white kid leather | Note (b) |
| 12 | Gorget patches | For COL above Line 20 Australian Army Rising Sun buttons |
| 13 | Insignia shoulder, 'AUSTRALIA' | |
| 14 | Nameplate | Not to be worn on parade |
| 15 | Patent leather black Baxter boots or R.M. Williams elastic sided, black leather boots | Note (e) |
| 16 | Patrol Blue White Jacket | Line 40 Australian Army Rising Sun buttons ^{Note (f)} |
| 17 | Orders, decorations and medals | If awarded ^{Note (g)} |
| 18 | Rank insignia | Officer rank to be pinned to shoulder cords |
| 19 | Sash scarlet | Note (h) |
| 20 | Shoulder boards black with scarlet bordering | |
| 21 | Shoulder cords | For officers |
| 22 | Slacks blue | |
| 23 | Socks black | |
| 24 | Sword and sword accessories | Notes (i) and (j) |
| 25 | Trade/skill qualification badge | Note (k) |
| 26 | Trousers blue | |
| 27 | Waist sash | Note (l) |
| 28 | White slung equipment | Note (b) |

Notes:

- (a) Worn by those entitled officers in [Chapter 3](#).
- (b) Worn by Colour/Flag Party.
- (c) The belt is to be worn with brass buckles and keepers.
- (d) Staff are to wear Corps collar badges.

- (e) Baxter patent leather black boots with plates may be worn by authorised ADFA members. Baxter patent leather black boots without plates fitted or the issued R.M. Williams elastic sided, black leather boots may be worn when with ceremonial orders of dress (on parade), General Duty Dress (polyesters), General Duty Service Dress and mess dress orders of dress, when ordered.
- (f) All members are to wear full size qualification badges (if qualified) on the jacket.
- (g) When worn as Ceremonial only.
- (h) RA Inf WO2 and SNCO only.
- (i) Swords are worn only by parade appointments. When swords are worn they are carried in a steel scabbard with sword/sabre as applicable to Corps.
- (j) General officers wear Mameluke sword. BRIG and COL wear steel scabbard and sword/sabre. A sword is not normally worn unless being received on parade or attending a ceremonial activity at which other spectators and guests would be wearing swords.
- (k) Only worn by those qualified members, IAW [Annex 4O](#).
- (l) General officers wear the gold and crimson silk waist sash. BRIG and COL wear crimson silk waist sash. Crimson silk is to be 7cm with two tassels for other officers only.

ADM

OFFICIAL

5I-7

Figure 5I-2: Patrol Blue White Jacket



AL5

OFFICIAL

DRESS ORDER NO ADFA 2 ‘MESS DRESS WHITE JACKET’

26. This order of dress is worn by authorised ADFA OCDTs for formal mess functions and other occasions of a formal nature when the wearing of this dress order is appropriate. ADFA staff are to wear mess dress orders of dress, IAW [Annex 5O](#). It consists of the following items of dress:

Table 5I-3: Dress Order No ADFA 2 ‘Mess Dress White Jacket’

| Serial | Item of Dress | Remarks |
|--------|---|--|
| 1 | Australian Army Rising Sun Badge embroidered on white background | |
| 2 | Badge commendation or soldiers medallion–miniature | If awarded |
| 3 | Badge ACB/ICB–miniature | If presented/awarded |
| 4 | Badge metal FFI PJI/PJI/PJM–miniature | If presented/awarded |
| 5 | Badge metal aircrew–miniature | If awarded |
| 6 | Bow tie black | |
| 7 | Chain jacket | Note (a) |
| 8 | Cummerbund scarlet | |
| 9 | Emblems of unit citation and/or awards–miniature | If awarded |
| 10 | Insignia shoulder, ‘AUSTRALIA’ | |
| 11 | Jacket mess white RAN with Australian Army Rising Sun collar Badges–miniature | Line 30 Australian Army Rising Sun buttons ^{Notes (b), (c) and (d)} |
| 12 | Orders, decorations and medals–miniature | If awarded |
| 13 | Patent leather black Baxter boots, Black shoes, black Court shoes or R.M. Williams elastic sided, black leather boots | Notes (e) and (f) |
| 14 | Rank insignia | Rank to be pinned to shoulder boards |
| 15 | Shoulder boards black with scarlet bordering | |
| 16 | Shirt white plain front | |
| 17 | Skirt blue | Note (g) |
| 18 | Slacks blue | Note (h) |
| 19 | Socks black | |
| 20 | Stockings/pantihose black | |
| 21 | Trade/skill qualification badge | Note (j) |
| 22 | Trousers blue | Note (i) |

Notes:

(a) Members are to wear gold chain, IAW [Annex 5O](#).

- (b) The Australian Army Rising Sun Badge (gold embroidered on white background) is worn on the upper left sleeve.
- (c) All ODCTs are to wear the miniature Australian Army Rising Sun Badge and full size qualification badges (if qualified) on the jacket.
- (d) Line 30 Australian Army Rising Sun buttons are to be positioned, IAW Navy Mess Manual, S4 Mess Dress.
- (e) Women can wear Court shoes when the skirt, slacks or trousers are worn.
- (f) Baxter patent leather black boots with plates may be worn by authorised ADFA members. Baxter patent leather black boots without plates fitted or the issued R.M. Williams elastic sided, black leather boots may be worn when with ceremonial orders of dress (on parade), General Duty Dress (polyesters), General Duty Service Dress and mess dress orders of dress, when ordered.
- (g) Skirts may not be an option for ADFA ODCTs, subject to COMDT ADFA approval. Court shoes are worn when the skirt is worn.
- (h) Slacks may not be an option for ADFA ODCTs, subject to COMDT ADFA approval.
- (i) When the Trousers black is worn, Court shoes (women only), Baxter patent leather black boots without plates fitted, Black shoes or the issued R.M. Williams elastic sided, black leather boots may be worn.
- (j) Only worn by those qualified members, IAW [Annex 4O](#).

Figure 5I-3: Mess Dress White Jacket for female



Figure 5I-4: Mess Dress White Jacket for male



DRESS ORDER NO ADFA 3 ‘SCOTTISH CEREMONIAL DRESS’

27. This order of dress is worn by authorised ADFA Pipes and Drums personnel only. This dress order is to be worn IAW [Annex 5E](#). The Drum Major will only wear this dress order whilst performing the duties of Pipes and Drums, without the band. It consists of the following items of dress:

Table 5I-4: Dress Order No ADFA 3 ‘Scottish Ceremonial Dress’

| Serial | Item of Dress | Remarks |
|--------|---|---|
| 1 | Australian Army Rising Sun Badge embroidered on white background | |
| 2 | Badge AIRN | If qualified |
| 3 | Badge commendation or soldiers medallion | If awarded |
| 4 | Badge ACB/ICB/MIB/RIB | If presented/awarded |
| 5 | Belt web white | Note (a) |
| 6 | Bonnet Balmoral | Note (b) |
| 7 | Collar badges | |
| 8 | Emblems of unit citation and/or awards | If awarded |
| 9 | Fly plaid with Australian Army Rising Sun Badge | Note (c) |
| 10 | Gaiters Highland with Patent leather black Baxter boots or R.M. Williams elastic sided, black leather boots | Note (d) |
| 11 | Garment flashes | |
| 12 | Gauntlets white | Note (e) |
| 13 | Hose Lovett green | |
| 14 | Insignia shoulder, ‘AUSTRALIA’ | |
| 15 | Kilt Tartan | Registered ADFA tartan pattern |
| 16 | Patrol Blue White Jacket modified cut-away | Line 30 Australian Army Rising Sun buttons ^{Notes (f) and (g)} |
| 17 | Orders, decorations and medals | If awarded |
| 18 | Rank insignia | |
| 19 | Sash Drum Major | Note (h) |
| 20 | Shoulder boards black with scarlet bordering | |
| 21 | Sporran Ceremonial, long hair | |
| 22 | Trade/skill qualification badge | Note (i) |

Notes:

- (a) The Pipes and Drums wear a white web belt fitted with Australian Army Rising Sun Badge gold buckle.

ADM

5I-13

- (b) The Pipe Major is to wear the Bonnet Glengarry.
- (c) Worn by the Pipe Major.
- (d) Baxter patent leather black boots with plates may be worn by authorised ADFA members. Baxter patent leather black boots without plates fitted or the issued R.M. Williams elastic sided, black leather boots may be worn when with ceremonial orders of dress (on parade), General Duty Dress (polyesters), General Duty Service Dress and mess dress orders of dress, when ordered.
- (e) Worn by the Drum Major, cymbal players and bass drummer.
- (f) All members are to wear full size qualification badges (if qualified) on the jacket.
- (g) Staff are to wear Corps badges.
- (h) Worn by Drum Major when performing with a marching band.
- (i) Only worn by those qualified members, IAW [Annex 4O](#).

Figure 5I-5: Dress Order No ADFA 3 'Scottish Ceremonial Dress'



Figure 5I-6: Dress Order No ADFA 3 'Scottish Ceremonial Dress' (Drum Major)



DRESS ORDER NO ADFA 4 ‘SCOTTISH MESS DRESS’

28. This order of dress is worn by authorised ADFA Pipers at mess functions when piping is required to be performed. It consists of the following items of dress:

Table 5I-5: Dress Order No ADFA 4 ‘Scottish Mess Dress’

| Serial | Item of Dress | Remarks |
|--------|--|--|
| 1 | Australian Army Rising Sun Badge embroidered on white background | |
| 2 | Badge commendation or soldiers medallion–miniature | If awarded |
| 3 | Badge ACB/ICB/MIB/RIB–miniature | If presented/awarded |
| 4 | Badge metal FFI PJI/PJI/PJM–miniature | If presented/awarded |
| 5 | Badge metal aircrew–miniature | If awarded |
| 6 | Bonnet Balmoral | Note (a) |
| 7 | Bow tie black | |
| 8 | Chain jacket | Note (b) |
| 9 | Cummerbund scarlet | |
| 10 | Emblems of unit citation and/or awards | If awarded |
| 11 | Gaiters Highland with Patent leather black Baxter boots, Black shoes or R.M. Williams elastic sided, black leather boots | Notes (c) and (d) |
| 12 | Garter flashes | |
| 13 | Hose Lovett green | |
| 14 | Insignia shoulder, ‘AUSTRALIA’ | |
| 15 | Jacket mess white RAN with Australian Army Rising Sun collar Badges–miniature | Line 30 Australian Army Rising Sun buttons ^{Notes (e), (f) and (g)} |
| 16 | Kilt Tartan | Registered ADFA tartan pattern |
| 17 | Orders, decorations and medals | If awarded |
| 18 | Rank insignia | Note (h) |
| 19 | Shoulder boards black with scarlet bordering | |
| 20 | Shirt white plain front | |
| 21 | Sporran dress imitation seal skin | |
| 22 | Trade/skill qualification badge | Note (i) |

Notes:

- (a) Worn when forming part of the Colour/Flag Party.
- (b) Members are to wear gold chain, IAW [Annex 5O](#).
- (c) Shoes Highland, Gillie Brogues, black may be worn in lieu.

ADM

5I-17

- (d) Baxter patent leather black boots with plates may be worn by authorised ADFA members. Baxter patent leather black boots without plates fitted or the issued R.M. Williams elastic sided, black leather boots may be worn when with ceremonial orders of dress (on parade), General Duty Dress (polyesters), General Duty Service Dress and mess dress orders of dress, when ordered.
- (e) The Australian Army Rising Sun Badge (gold embroidered on white background) is worn on the upper left sleeve.
- (f) All ODCTs are to wear the miniature Australian Army Rising Sun Badge and full size qualification badges (if qualified) on the jacket.
- (g) Line 30 Australian Army Rising Sun buttons are to be positioned, IAW Navy Mess Manual, S4 Mess Dress.
- (h) OCDTs do not wear rank insignia. Staff are to wear appropriate rank insignia, IAW [Annex 5O](#).
- (i) Only worn by those qualified members, IAW [Annex 4O](#).

Figure 5I-7: Dress Order No ADFA 4 'Scottish Mess Dress'



ADM

OFFICIAL

51-19

AL5

OFFICIAL

ROYAL MILITARY COLLEGE—DUNTROON DRESS

AUTHORITY FOR WEARING

1. RMC–D Dress is to be worn by members of the Corps of Staff Cadets. Members of the Corps of Staff Cadets has the meaning of members posted to RMC–D as Corps of Staff Cadets staff and Staff Cadets (SCDTs) in any of the following positions:
 - a. CO of the Corps of Staff Cadets
 - b. 2IC of the Corps of Staff Cadets
 - c. SO2 Protocol of the Corps of Staff Cadets
 - d. SO3 Cadets
 - e. ADJT of the Corps of Staff Cadets
 - f. RSM of the Corps of Staff Cadets
 - g. OC of a Corps of Staff Cadets Company
 - h. Drill Wing staff
 - i. SCDTs of the following sub-units:
 - (1) Alamein Company
 - (2) Gallipoli Company
 - (3) Kapyong Company
 - (4) Kokoda Company
 - (5) Long Tan Company
 - (6) Neville Howse, VC Platoon
 - j. Band of RMC.
2. Special appointments and selected personnel in [Chapter 1](#) holding appointments at HQ RMC–A, are not covered in this annex. All personnel posted to RMC–D as staff are to comply with [Chapter 5](#).
3. All RMC–D orders of dress are approved for issue to members of the Corps of Staff Cadets. The provisions for RMC–D Dress are in Block Scale 3002/27.

ITEMS OF ROYAL MILITARY COLLEGE–DUNTROON DRESS

Army Individual Readiness Notice badge

4. Whilst at RMC–D, SCDTs are not entitled to wear the AIRN Badge; however, they are entitled to wear all other awards.

Boots

5. Baxter patent leather black boots with plates are to be worn by members of the Corps of Staff Cadets when on a ceremonial parade. Members of the Corps of Staff Cadets are authorised to wear Baxter boots with General Duty Dress (polyesters).

Canes

6. Canes are authorised to be carried by the following members:

- a. ADJT of the Corps of Staff Cadets
- b. SCDT CSM
- c. SCDT Bn Orderly SGT

Cap badge

7. The RMC–D Corps of Staff Cadets badge is to be worn by SCDTs with the Blue Service cap and Hat KFF. Staff are to wear their Corps/Regiment hat badge. The position of the badge is in accordance with (IAW) [Chapter 3](#), [Chapter 4](#) and [Annex 4D](#).

Chinstrap

8. Members of the Corps of Staff Cadets are to wear the buckle on the right cheek when wearing the Hat KFF, worn with the brim down. It has become a tradition because GEN Bridges was wearing his slouch hat this way when he was wounded at Gallipoli. The tradition was commenced at RMC in 1932 and only applies when the brim is turned down. When the brim is turned up, the buckle is worn on the left cheek, IAW [Chapter 3](#).

Collar badge

9. The RMC–D Corps of Staff Cadets collar badge is the same badge as the cap badge and is worn by SCDTs on the Patrol Blue Jacket/White Jacket and Mess Dress White Jacket. Staff are to wear their Corps/Regiment collar badge. The position of the badge on Patrol Blue Jacket/White Jacket is IAW [Annex 4D](#). The position of the badge with Mess Dress orders of dress is IAW [Annex 5O](#). The collar badge, when worn on the Patrol Blue White Jacket, is to be backed with scarlet felt, which is trimmed 3 mm around the badge, IAW Figure 5J–1.

Figure 5J-1: Collar badge trimmed with scarlet felt



Colour Sergeant

10. Cadet Colour SGTs within the Corps of Staff Cadets are to wear the rank in Figure 5J-2, when dressed in Patrol Blue Jacket/White Jacket and Mess Dress White Jacket with the relevant backing colour to match the jacket worn.

Figure 5J-2: Colour Sergeant Rank



Gold piping

11. The following members are to wear gold piping on the sleeves of the Patrol Blue Jacket/White Jacket and Mess Dress White Jacket, IAW Figure 5J-3:

- a. Senior Under Officer – Double Piping
- b. Under Officer – Single Piping.

Figure 5J-3: Jacket gold piping



Lanyard

12. SCDTs of Sovereigns' Company are authorised to wear the scarlet lanyard. All other SCDTs are authorised to wear the khaki lanyard.

Mess Dress

13. Members of the Corps of Staff Cadets are entitled to wear Mess Dress White Jacket. Members eligible to wear the gold piping on the sleeves of the jacket are in paragraph 11 to this annex.

Patrol Blue Jacket/White Jacket and Blue Service cap

14. Members of the Corps of Staff Cadets are authorised to wear the Patrol Blue Jacket/White Jacket and Blue Service cap. Staff of The Corp of Staff Cadets are authorised to wear the Blue Service cap in General Duty Dress (polyesters) in the course of their duties accompanying the same dress order of the day for the SCDT.

Puggaree

15. Members of the Corps of Staff Cadets are to wear the distinctive olive drab puggaree, with the UCP worn centrally on the right side of the puggaree, with the Hat KFF. The puggaree has eight pleats instead of the standard seven on the khaki puggaree. The eight pleats represent each state and territory of Australia as well as New Zealand.

Rank slides

16. AMCU Ranks slides are to be worn by all SCDTs at RMC-D. The rank slide consists of an AMCU standard slide, with the letters 'RMC' embroidered in black in place of the 'AUSTRALIA', and the RMC-D UCP embroidered at the top of the slide, as shown in Figure 5J-4.

Figure 5J-4: Royal Military College–Duntroon Australian Multi-cam Camouflage Uniform Rank slide



Sam Browne Belt

17. The Sam Browne Belt, shoulder strap and belt hooks are authorised to be worn by the Cadet Orderly Officer, IAW [Chapter 3](#) and this annex.

Scarlet shoulder sash

18. The following SCDTs are authorised to wear the scarlet shoulder sash, IAW [Chapter 3](#):

- a. Colour SGTs
- b. SGTs
- c. Bn Orderly SGT.

Shoulder boards

19. On appointment as SCDT, cadets are to wear khaki shoulder boards with insignia shoulder title 'RMC'. They are not to be worn with the Jacket Service dress or Utility Jacket. The position of the insignia is IAW [Chapter 3](#).

20. Foreign Cadets posted to RMC–D do not wear insignia on shoulder boards.

21. Black shoulder boards with scarlet bordering and insignia shoulder title 'AUSTRALIA' is to be worn with the Patrol Blue White Jacket. The position of the insignia is IAW [Chapter 3](#).

22. Officers are to wear shoulder cords on the Patrol Blue White Jacket, IAW [Chapter 3](#).

Shoulder Flash

23. The RMC-D Shoulder Flash, in Figure 5J-5 is to be worn on a khaki brassard by SCDTs that hold rank, when wearing Dress Orders No CSC 3, CSC 4, CSC 5, CSC 6, CSC 7 and CSC 8.

Figure 5J-5: Shoulder Flash



FOREIGN CADETS

24. On the AMCU Shirt, Foreign cadets are to wear their country's name embroidered in black on an AMCU background in place of the Australian Army Rising Sun Badge. Foreign cadets are to wear a velcro patch of their country's national flag in place of the ANF.

25. On the polyester khaki shirt, foreign cadets are to wear a patch of their country's national flag in place of the Australian Army Rising Sun Badge.

26. Foreign cadets issued the Patrol Blue Jacket/White Jacket and Mess Dress White Jacket, are to wear a patch of their country's national flag in place of the Australian Army Rising Sun Badge.

27. Foreign cadets are authorised to wear their General Duty Dress (AMCU) equivalent whilst in the barracks environment only; they are to wear Field Dress (AMCU) or Combat Dress (AMCU) whilst in the field environment.

28. When the dress of the day is General Duty Dress (polyesters), or a ceremonial order of dress, foreign cadets are to wear their equivalent order of dress.

FOREIGN STAFF

29. Foreign staff are to wear their General Duty Dress (AMCU) and Field Dress (AMCU) equivalent as dress of the day whilst in barracks or field environments respectively.

30. When the dress of the day is General Duty Dress (polyesters), or a ceremonial order of dress, foreign staff are to wear their equivalent order of dress.

ROYAL AUSTRALIAN AIR FORCE CADETS

31. RAAF cadets are authorised to wear General Duty Dress (AMCU) and Field Dress (AMCU) as dress of the day whilst in barracks and field environments respectively.

32. When the dress of the day is General Duty Dress (polyesters), or a ceremonial order of dress, RAAF cadets are to wear their single service equivalent order of dress.

33. RAAF cadets are to wear the Patrol Blue order of dress when required for ceremonial parades.

ROYAL MILITARY COLLEGE BAND

34. The Band of RMC may continue to wear Dress Order No BC1–No 1 AABC Ceremonial Dress (RMC–D) on specific occasions when the Corps of Staff Cadets are wearing Patrol Blue order of dress and Blue Service cap, IAW [Annex 5D](#).

ROYAL MILITARY COLLEGE–DUNTROON ORDERS OF DRESS

35. The orders of dress specific to members of the Corps of Staff Cadets are in Table 5J-1.

Table 5J-1: Orders of Dress

| Dress Number | Dress Order Title | Table |
|---------------------|---|--------------|
| CSC 1 | Patrol Blue White Jacket | 5J-2 |
| CSC 2 | Patrol Blue Jacket | 5J-3 |
| CSC 3 | Polyester Dress–CO's Order White Dress | 5J-4 |
| CSC 4 | Polyester Dress–Corps of Staff Cadets General Duty Dress | 5J-5 |
| CSC 5 | Polyester Dress–Orderly Dress | 5J-6 |
| CSC 6 | Polyester Dress–CO's Order White Dress Cold Weather | 5J-7 |
| CSC 7 | Polyester Dress–Corps of Staff Cadets General Duty Dress Cold Weather | 5J-8 |
| CSC 8 | Polyester Dress–Orderly Dress Cold Weather | 5J-9 |

DRESS ORDER NO CSC 1 'PATROL BLUE WHITE JACKET'

36. This order of dress is worn on ceremonial parades and when ordered. It consists of the following items of dress:

Table 5J-2: Dress Order No CSC 1 'Patrol Blue White Jacket'

| Serial | Items of Dress | Remarks |
|---------------|--|--|
| 1 | Blue Service cap with RMC-D cap badge | Line 20 Australian Army Rising Sun buttons |
| 2 | Braces white | Note (a) |
| 3 | Patrol Blue White Jacket | Line 40 and line 30 Australian Army Rising Sun buttons |
| 4 | Collar badges with scarlet felt background | |
| 5 | Shoulder boards black with scarlet bordering | |

| Serial | Items of Dress | Remarks |
|--------|---|---|
| 6 | Insignia shoulder, 'AUSTRALIA' | Note (b) |
| 7 | Badge commendation or soldiers medallion | If presented/awarded |
| 8 | Emblems of unit citation and/or awards | If awarded |
| 9 | Trade/skill qualification badge | Note (c) |
| 10 | Nameplate | Not to be worn on parade |
| 11 | Australian Army Rising Sun Badge embroidered Gold and Red on white background | |
| 12 | Badge ACB/ICB/MIB/RIB | If presented/awarded |
| 13 | Orders, decorations and medals | If awarded |
| 14 | Rank insignia | |
| 15 | Sash scarlet | Note (d) |
| 16 | Belt web white with brass | |
| 17 | Belt hooks | |
| 18 | Sword and sword accessories | Notes (e) and (f) |
| 19 | Sling rifle white | |
| 20 | Gloves white kid leather | |
| 21 | Trousers blue | |
| 22 | Socks black | |
| 23 | Baxter patent leather black boots with plates or R.M. Williams elastic sided, black leather boots | Note (g) |
| 24 | Aiguillette | Note (h) |
| 25 | Badge AIRN | Note (i) |
| 26 | Waist sash crimson silk | Note (j) |
| 27 | Shoulder cords | Officer rank to be pinned to shoulder cords |
| 28 | Gorget patches | For COL above Line 20 Australian Army Rising Sun buttons |

Notes:

- (a) Worn when required.
- (b) Australian SCDTs only.
- (c) Only worn by those qualified members, IAW [Annex 40](#).
- (d) RA Inf WO2 and SNCO, and authorized members of the Corps of Staff Cadets and OCDTs, such as Guides SGT, Colour/Banner Escorts.
- (e) When worn as Ceremonial only.
- (f) Swords are worn only by parade appointments. When swords are worn they are carried in a steel scabbard with sword/sabre as applicable to Corps.

ADM

5J-9

- (g) Baxter patent leather black boots with plates may be worn by authorised RMC-D members. Baxter patent leather black boots or the issued R.M. Williams elastic sided, black leather boots may be worn when with ceremonial orders of dress (on parade), General Duty Dress (polyesters), General Duty Service Dress and Mess Dress orders of dress, when ordered.
- (h) Worn by those entitled officers in [Chapter 3](#).
- (i) Not worn by SCDTs.
- (j) General officers wear the gold and crimson silk waist sash. BRIG and COL wear crimson silk waist sash. Crimson silk is to be 7cm with two tassels for other officers only.

Figure 5J-6: Dress Order No CSC 1 'Patrol Blue White Jacket', with Rifle



Figure 5J-7: Dress Order No CSC 1 'Patrol Blue White Jacket', with Sword



DRESS ORDER NO CSC 2 'PATROL BLUE JACKET'

37. This order of dress is worn on ceremonial parades and when ordered. It consists of the following items of dress:

Table 5J-3: Dress Order No CSC 2 'Patrol Blue Jacket'

| Serial | Items of Dress | Remarks |
|---------------|---|--|
| 1 | Blue Service cap with RMC-D cap badge | Line 20 Australian Army Rising Sun buttons |
| 2 | Braces white | Note (a) |
| 3 | Patrol Blue White Jacket | Line 40 and line 30 Australian Army Rising Sun buttons |
| 4 | Collar badges with scarlet felt background | |
| 5 | Shoulder boards black with scarlet bordering | |
| 6 | Insignia shoulder, 'AUSTRALIA' | Note (b) |
| 7 | Badge commendation or soldiers medallion | If presented/awarded |
| 8 | Emblems of unit citation and/or awards | If awarded |
| 9 | Trade/skill qualification badge | Note (c) |
| 10 | Nameplate | Not to be worn on parade |
| 11 | Australian Army Rising Sun Badge embroidered Gold and Red on white background | |
| 12 | Badge ACB/ICB/MIB/RIB | If presented/awarded |
| 13 | Orders, decorations and medals | If rewarded |
| 14 | Rank insignia | |
| 15 | Sash scarlet | Note (d) |
| 16 | Belt web white with brass | |
| 17 | Belt hooks | |
| 18 | Sword and sword accessories | Notes (e) and (f) |
| 19 | Sling rifle white | |
| 20 | Gloves white kid leather | |
| 21 | Trousers blue | |
| 22 | Socks black | |
| 23 | Baxter patent leather black boots with plates or R.M. Williams elastic sided, black leather boots | Note (g) |
| 24 | Aiguillette | Note (h) |
| 25 | Badge AIRN | Note (i) |
| 26 | Waist sash crimson silk | Note (j) |

Notes:

(a) Worn when required.

ADM

5J-13

- (b) Australian SCDTs only.
- (c) Only worn by those qualified members, IAW [Annex 4O](#).
- (d) RA Inf WO2 and SNCO, and authorized members of the Corps of Staff Cadets and OCDTs, such as Guides SGT, Colour/Banner Escorts.
- (e) When worn as Ceremonial only.
- (f) Swords are worn only by parade appointments. When swords are worn they are carried in a steel scabbard with sword/sabre as applicable to Corps.
- (g) Baxter patent leather black boots with plates may be worn by authorised RMC-D members. Baxter patent leather black boots or the issued R.M. Williams elastic sided, black leather boots may be worn when with ceremonial orders of dress (on parade), General Duty Dress (polyesters), General Duty Service Dress and Mess Dress orders of dress, when ordered.
- (h) Worn by those entitled officers in Chapter 3.
- (i) Not worn by SCDTs.
- (j) General officers wear the gold and crimson silk waist sash. BRIG and COL wear crimson silk waist sash. Crimson silk is to be 7cm with two tassels for other officers only.

Figure 5J-8: Dress Order No CSC 2 'Patrol Blue Jacket', with Rifle



Figure 5J-9: Dress Order No CSC 2 'Patrol Blue Jacket', with Sword



DRESS ORDER NO CSC 3 'POLYESTER DRESS-CO'S ORDER WHITE DRESS'

38. This order of dress is worn on ceremonial parades in lieu of Dress Order No CSC 1 'Patrol Blue White Jacket' and CSC 2 'Patrol Blue Jacket', when ordered. It consists of the following items of dress:

Table 5J-4: Dress Order No CSC 3 'Polyester Dress-CO's Order White Dress'

| Serial | Item of Dress | Remarks |
|--------|---|-----------------------|
| 1 | Australian Army Rising Sun Badge embroidered on khaki background | |
| 2 | Badge AIRN | If qualified Note (a) |
| 3 | Badge commendation or soldiers medallion | If awarded |
| 4 | Badge ACB/ICB/MIB/RIB | If presented/awarded |
| 5 | Belt hooks | |
| 6 | Belt white | |
| 7 | Belt Sam Browne, shoulder strap and belt hooks | Officers and RSM only |
| 8 | Blue Service cap with RMC-D cap badge | Note (b) |
| 9 | Boards shoulder khaki | |
| 10 | Brassard | Note (c) |
| 11 | Emblems of unit citation and/or awards | If awarded |
| 12 | Gloves white kid leather | |
| 13 | Lanyard and 'RMC' insignia shoulder | |
| 14 | Nameplate | Not worn on parade |
| 15 | Patent leather black Baxter boots or R.M. Williams elastic sided, black leather boots | Note (d) |
| 16 | Rank insignia | |
| 17 | Orders, decorations and medals | If awarded |
| 18 | Sash scarlet | Note (e) |
| 19 | Shirt short sleeve polyester | |
| 20 | Trousers polyester | |
| 21 | Socks khaki | |
| 22 | Sling rifle white | |
| 23 | Sword and sword accessories | Note (f) |
| 24 | Trade/skill qualification badge | Note (g) |

Notes:

- (a) Not worn by SCDTs.
- (b) Staff wear CORPs/Regimental badge
- (c) For SCDTs holding rank only.

ADM

5J-17

- (d) Baxter patent leather black boots with plates may be worn by authorised RMC-D members. Baxter patent leather black boots or the issued R.M. Williams Elastic sided black leather boots may be worn when with ceremonial orders of dress (on parade), General Duty Dress (polyesters), General Duty Service Dress and Mess Dress orders of dress, when ordered.
- (e) RA Inf WO2 and SNCO, and authorised members of the Corps of Staff Cadets and OCDTs, such as Guides SGT, Colour/Banner Escorts.
- (f) Only worn by Ensigns of Colours and Banners, SUO, UOs and RSM, IAW Chapter 3.
- (g) Only worn by those qualified members, IAW [Annex 40](#).

Figure 5J-10: Dress Order No CSC 3 'Polyester Dress-CO's Order White Dress', with Rifle



AL5

Figure 5J-11: Dress Order No CSC 3 'Polyester Dress-CO's Order White Dress', with Sword



**DRESS ORDER NO CSC 4 'POLYESTER DRESS-CORPS OF STAFF
CADETS GENERAL DUTY DRESS'**

39. This order of dress is the Corps of Staff Cadets dress of the day. It consists of the following items of dress:

**Table 5J-5: Dress Order No CSC 4 'Polyester Dress-Corps of Staff Cadets
General Duty Dress'**

| Serial | Item of Dress | Remarks |
|--------|---|------------------------|
| 1 | Australian Army Rising Sun Badge embroidered on khaki background | |
| 2 | Badge AIRN | If qualified Note (a) |
| 3 | Badge commendation or soldiers medallion | If awarded |
| 4 | Badge ACB/ICB/MIB/RIB | If presented/awarded |
| 5 | Belt khaki 32 mm | |
| 6 | Blue Service cap with RMC-D cap badge | Note (b) |
| 7 | Boards shoulder khaki | Officer and SCDT only |
| 8 | Brassard | Note (c) |
| 9 | Emblems of unit citation and/or awards | If awarded |
| 10 | Hat KFF with RMC-D hat badge | Brim down |
| 11 | Lanyard and 'RMC' insignia shoulder | |
| 12 | Nameplate | |
| 13 | Patent leather black Baxter boots, Black shoes, black Court shoes or R.M. Williams elastic sided, black leather boots | Notes (d), (e) and (f) |
| 14 | Puggaree distinctive colour | |
| 15 | Rank insignia | |
| 16 | Ribbons of orders, decorations and medals | If awarded |
| 17 | Shirt short sleeve polyester | |
| 18 | Socks khaki | |
| 19 | Trade/skill qualification badge | Note (g) |
| 20 | Trousers polyester | |

Notes:

- (a) Not worn by SCDTs.
- (b) Only worn by Drill Wing staff.
- (c) For SCDTs holding rank only.
- (d) When trousers are worn, women can either wear Court shoes, the issued R.M. Williams elastic sided, black leather boot or Baxter patent leather black boots with plates.

ADM

5J-20

- (e) Baxter patent leather black boots with plates may be worn by authorised RMC-D members. Baxter patent leather black boots or the issued R.M. Williams Elastic sided black leather boots may be worn when with ceremonial orders of dress (on parade), General Duty Dress (polyesters), General Duty Service Dress and Mess Dress orders of dress, when ordered.
- (f) Not worn by SCDTs.
- (g) Only worn by those qualified members, IAW [Annex 4O](#).

Figure 5J-12: Dress Order No CSC 4 'Polyester Dress-Corps of Staff Cadets General Duty Dress'



DRESS ORDER NO CSC 5 'POLYESTER DRESS-ORDERLY DRESS'

40. This order of dress is worn by the Battalion Orderly Officer, Battalion Orderly SGT, Company Orderlies and when ordered. It consists of the following items of dress:

Table 5J-6: Dress Order No CSC 5 'Polyester Dress-Orderly Dress'

| Serial | Item of Dress | Remarks |
|--------|---|----------------------|
| 1 | Australian Army Rising Sun Badge embroidered on khaki background | |
| 2 | Badge AIRN | Note (a) |
| 3 | Badge commendation or soldiers medallion | If awarded |
| 4 | Badge ACB/ICB/MIB/RIB | If presented/awarded |
| 5 | Belt black and belt hooks | |
| 6 | Belt Sam Browne, shoulder strap and belt hooks | Note (b) |
| 7 | Brassard | Note (c) |
| 8 | Blue Service cap with hat badge | |
| 9 | Emblems of unit citation and/or awards | If awarded |
| 10 | Boards shoulder khaki | SCDT |
| 11 | Embroidered rank slides | Officer |
| 12 | Lanyard and 'RMC' insignia shoulder | |
| 13 | Ribbons of orders, decorations and medals | If awarded |
| 14 | Shirt short sleeve polyester | |
| 15 | Trousers polyester | |
| 16 | Socks khaki | |
| 17 | Trade/skill qualification badge | Note (d) |
| 18 | Nameplate | Not worn on parade |
| 19 | Baxter patent leather black boots with plates or R.M. Williams elastic sided, black leather boots | Note (e) |

Notes:

- (a) Not worn by SCDTs.
- (b) Only worn by the Battalion Orderly Officer.
- (c) For SCDTs holding rank only.
- (d) Only worn by those qualified members, IAW [Annex 4O](#).
- (e) Baxter patent leather black boots with plates may be worn by authorised RMC-D members. Baxter patent leather black boots or the issued R.M. Williams elastic sided, black leather boots may be worn when with ceremonial orders of dress (on parade), General Duty Dress (polyesters), General Duty Service Dress and mess dress orders of dress, when ordered.

**Figure 5J-13: Dress Order No CSC 5 'Polyester Dress-Orderly Dress',
Company Orderly**



**Figure 5J-14: Dress Order No CSC 5 'Polyester Dress- Orderly Dress',
Battalion Orderly SGT**

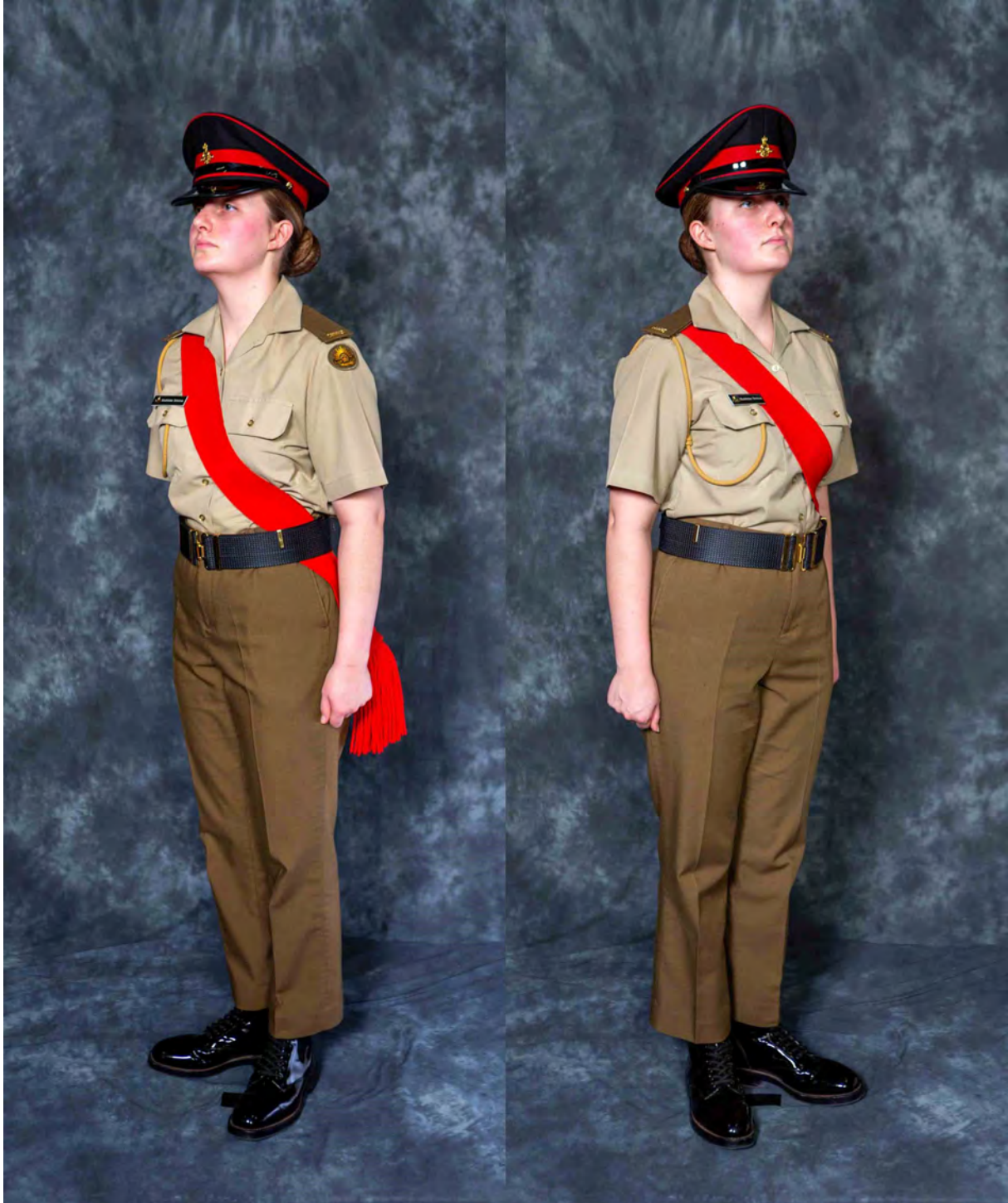

**Figure 5J-15: Dress Order No CSC 5 'Polyester Dress- Orderly Dress',
Battalion Orderly Officer**



DRESS ORDER NO CSC 6 'POLYESTER DRESS-CO'S ORDER WHITE DRESS COLD WEATHER'

41. This order of dress is worn on ceremonial parades in lieu of Dress Order No CSC 1 'Patrol Blue White Jacket' and CSC 2 'Patrol Blue Jacket', when ordered. It consists of the following items of dress:

Table 5J-7: Dress Order No CSC 6 'Polyester Dress-CO's Order White Dress Cold Weather'

| Serial | Item of Dress | Remarks |
|--------|---|--|
| 1 | Australian Army Rising Sun Badge embroidered on khaki background | |
| 2 | Badge AIRN | If qualified Note (a) |
| 3 | Badge commendation or soldiers medallion | If awarded |
| 4 | Badge ACB/ICB/MIB/RIB | If presented/awarded |
| 5 | Belt hooks | |
| 6 | Belt white | |
| 7 | Belt Sam Browne, shoulder strap and belt hooks | Officers and RSM only |
| 8 | Blue Service cap with RMC-D cap badge | Note (b) |
| 9 | Boards shoulder khaki | |
| 10 | Brassard | Note (c) |
| 11 | Emblems of unit citation and/or awards | If awarded |
| 12 | Gloves white kid leather | |
| 13 | Lanyard and 'RMC' insignia shoulder | |
| 14 | Nameplate | Not worn on parade |
| 15 | Patent leather black Baxter boots or R.M. Williams elastic sided, black leather boots | Note (d) |
| 16 | Rank insignia | |
| 17 | Orders, decorations and medals | If awarded |
| 18 | Sash scarlet | Note (e) |
| 19 | Shirt Long sleeve polyester | |
| 20 | Necktie Khaki polyester | |
| 21 | Jacket Service Dress | Line 40 and line 30 Australian Army Rising Sun buttons |
| 22 | Trousers polyester | |
| 23 | Socks khaki | |
| 24 | Sling rifle white | |
| 25 | Sword and sword accessories | Note (f) |
| 26 | Trade/skill qualification badge | Note (g) |

Notes:

- (a) For SCDTs holding rank only.
- (b) Baxter patent leather black boots with plates may be worn by authorised RMC-D members. Baxter patent leather black boots or the issued R.M. Williams Elastic sided black leather boots may be worn when with ceremonial orders of dress (on parade), General Duty Dress (polyesters), General Duty Service Dress and Mess Dress orders of dress, when ordered.
- (c) Only worn by Ensigns of Colours and Banners, SUO, UOs and RSM, IAW Chapter 3.

Figure 5J-16: Dress Order No CSC 6 'Polyester Dress-CO's Order White Dress Cold Weather', with Rifle



Figure 5J-17: Dress Order No CSC 6 'Polyester Dress-CO's Order White Dress Cold Weather', with Sword



**DRESS ORDER NO CSC 7 'POLYESTER DRESS-CORPS OF STAFF
CADETS GENERAL DUTY DRESS COLD WEATHER'**

42. This order of dress is the Corps of Staff Cadets dress of the day. It consists of the following items of dress:

**Table 5J-8: Dress Order No CSC 7 'Polyester Dress-Corps of Staff Cadets
General Duty Dress Cold Weather'**

| Serial | Item of Dress | Remarks |
|---------------|---|---|
| 1 | Dress Order No 2F | Table 5-10 |
| 2 | Blue Service cap with cap badge | Note (a) |
| 3 | Boards shoulder khaki | Officer and SCDT only |
| 4 | Brassard | Note (b) |
| 5 | Jacket Service dress | Line 40 and line 30 Australian Army Rising Sun buttons Note (c) |
| 6 | Baxter patent leather black boots with plates, Black shoes, black Court shoes or R.M. Williams elastic sided, black leather boots | Notes (d) and (e) |

Notes:

- (a) Only worn by Drill Wing staff.
- (b) For SCDTs holding rank only.
- (c) Optional or when ordered, IAW Dress Order No 1C.
- (d) When trousers are worn, women can either wear Court shoes, the issued R.M. Williams elastic sided, black leather boot or Baxter patent leather black boots with plates.
- (e) Baxter patent leather black boots with plates may be worn by authorised RMC-D members. Baxter patent leather black boots or the issued R.M. Williams Elastic sided black leather boots may be worn when with ceremonial orders of dress (on parade), General Duty Dress (polyesters), General Duty Service Dress and Mess Dress orders of dress, when ordered.

**Figure 5J-18: Dress Order No CSC 7 'Polyester Dress-Corps of Staff Cadets
General Duty Dress Cold Weather'**



Figure 5J-19: Dress Order No CSC 7 'Polyester Dress-Corps of Staff Cadets General Duty Dress Cold Weather', with Jacket Service Dress



**DRESS ORDER NO CSC 8 'POLYESTER DRESS-ORDERLY DRESS
COLD WEATHER'**

43. This order of dress is worn by Battalion Orderly Officer, Battalion Orderly SGT, Company Orderlies and when ordered. It consists of the following items of dress:

Table 5J-9: Dress Order No CSC 8 'Polyester Dress-Orderly Dress Cold Weather'

| Serial | Item of Dress | Remarks |
|---------------|---|--------------------|
| 1 | Dress Order No 1B | Table 5-3 |
| 2 | Belt Sam Browne, shoulder strap and belt hooks | Note (a) |
| 3 | Brassard | Note (b) |
| 4 | Blue Service cap with hat badge | |
| 5 | Nameplate | Not worn on parade |
| 6 | Patent leather black Baxter boots or R.M. Williams elastic sided, black leather boots | Note (c) |

Notes:

- (a) Only worn by the Battalion Orderly Officer.
- (b) For SCDTs holding rank only.
- (c) Baxter patent leather black boots with plates may be worn by authorised RMC-D members. Baxter patent leather black boots or the issued R.M. Williams elastic sided, black leather boots may be worn when with ceremonial orders of dress (on parade), General Duty Dress (polyesters), General Duty Service Dress and mess dress orders of dress, when ordered.

Figure 5J-20: Dress Order No CSC 8 'Polyester Dress-Orderly Dress Cold Weather', Company Orderly



Figure 5J-21: Dress Order No CSC 8 'Polyester Dress-Orderly Dress Cold Weather', Orderly Sergeant



Figure 5J-22: Dress Order No CSC 8 'Polyester Dress-Orderly Dress Cold Weather', Orderly Officer



PHYSICAL TRAINING INSTRUCTOR DRESS

GENERAL

1. This annex details the special items of dress to be worn by Army Physical Training Instructor (PTI) and Fitness Leader (FL) when performing administrative and instructional duties. Note: the term Fitness Leader (FL) incorporates ADF Fitness Leaders (ADFFL) Sub unit PT Leader and Combat Fitness Leader (CFL).

ELIGIBILITY

2. Distinctive red and white PTI Dress IAW Table 5K-2 is authorised to be worn by NCOs, SNCOs and Warrant Officers qualified PTI posted to authorised ECN 185 establishment positions and IAW para 1.7. Qualified FL are authorised to wear specific PT Dress IAW Table 5K-3 when conducting PT sessions and or PT related administrative activities.

ENTITLEMENT

3. Entitled personnel are issued with the range of garments, in accordance with (IAW) Block Scale 3004/05.

WEARING OF PHYSICAL TRAINING INSTRUCTOR DRESS

4. The following provisions are to be adhered to when wearing PTI Dress:
- a. T-shirt, Grey (short or long sleeve) with Army PTI trade qualification badge centre front and red athletic shorts are only to be worn when conducting PT sessions or preparing lessons.
 - b. Athletic shorts red are not to be worn in lieu of the red dress shorts when wearing the white collared PTI shirt.
 - c. PTI headdress (white Kepi cap) is to be worn in accordance with ADM Chap 3 when wearing the PTI Dress.

EMBELLISHMENT OF PHYSICAL TRAINING INSTRUCTOR DRESS

5. The only embellishments worn on PTI Dress are badges of rank, embroidered red on white background, PTI trade qualification badge and embroidered red on white background name tag. (Nameplates are not to be worn)
6. Badges of rank, PTI trade qualification badge and name tag are to be positioned on the shirt and jacket, athletic track and wet weather as detailed below and shown in figure 5K-1 and 5K-2.
- a. Shirt - left-hand edge of the name tag is positioned 6 cm from the centre of the shirt and the top of the badges of rank is positioned 14 cm from top of the shirt shoulder seam.

ADM

5K-2

- b. Jacket - left-hand edge of the name tag is positioned 6 cm from the centre of the zipper of the jacket and the badges of rank is positioned half-on-red and half-on-white on the jacket sleeves, so that the top rank bar sits level with the top edge of the red strip, 14 cm from the shirt shoulder seam.
7. The provisions for the PTI trade qualification badge is In [Appendix 4O14](#). The PTI trade qualification badge is embroidered directly onto PT garments during manufacture. Officers who have qualified as a PTI are entitled to wear the PTI trade qualification badge on approved garments only.

Figure 5K-1: Positioning of embellishments on the Shirt, White with Collar



Figure 5K-2: Positioning of embellishments on the Suit, Athletic Track



ORDERS OF DRESS

8. The orders of dress worn by PTI, and FL are in Table 5K-1.

Table 5K-1: Dress Order No PT 1 ‘Physical Training Dress’

| Dress Number | Dress Order Title | Table |
|--------------|----------------------------|-------|
| PT 1 | Physical Training Dress | 5K-2 |
| PT 2 | FL Physical Training Dress | 5K-3 |

DRESS ORDER NO PT 1 ‘PHYSICAL TRAINING DRESS’

9. This order of dress is to be worn only by qualified PTI when engaged in PT instructional or administrative duties. Garments are worn as appropriate to the activity being performed. It consists of the following items of dress:

Table 5K-2: Dress Order No PT 1 ‘Physical Training Dress’

| Serial | Item of Dress | Remarks |
|--------|---|-----------------------|
| 1 | Cap kepi white PTI, with PTI trade badge | Note (a) |
| 2 | Jacket inclement weather | Note (b) |
| 3 | Name tag red on white background | Note (c) |
| 4 | Rank insignia | |
| 5 | Shirt white, with collar two bottom buttons done up | Note (d) |
| 6 | Shorts athletic, red | Notes (e) and (f) |
| 7 | Shorts dress PTI, red | Note (d) |
| 8 | Shoes running | |
| 9 | Shoes gymnasium | |
| 10 | Skirt red PTI | Note (h) |
| 11 | Socks athletic white | Note (i) |
| 12 | Suit athletic track | Note (j) |
| 13 | Trousers wet weather | Note (b) |
| 14 | Trunks swimming | Note (k) |
| 15 | T-Shirt Grey (Long or Short Sleeve), with PTI trade qualification badge | Note (e), (f) and (g) |

Notes:

- (a) The PTI cap is to be worn, IAW [Chapter 3](#). PTI cap is not to be worn for indoor instruction. PTI may remove the cap during rope climbing or other outdoor activities where headdress may compromise safety.
- (b) To be worn as an inclement weather garment. It may be worn instead of or in addition to the tracksuit in times of inclement weather for outside instructional/administrative duties. It is to be removed when indoors.

OFFICIAL

ADM

5K-6

- (c) Initial issue of six name tags for PTI.
- (d) Worn for all administrative duties when not conducting PT. May also be worn for classroom instruction and assessments where physical demonstrations are not required. The shirt is to be tucked in at all times.
- (e) Not to be worn in messes.
- (f) Only to be worn when performing instructional duties. Not to be worn in lieu of shorts, dress PTI, red.
- (g) Both T-Shirt Grey (long and short sleeve) can be worn as Battle PT dress with boots or runners. T-shirt Grey (Long sleeve) may be worn with body armour in a Physical Training setting.
- (h) Optional as ordered for female PTIs.
- (i) Must cover the ankle (medial & lateral malleolus). Socks may have 1 or 2 visible small embellished logos. When wearing running shoes with Battle PT dress the wearing of either white, black or khaki socks is permitted.
- (j) The top and bottom can be worn separately except when on parade. It can be worn in combination with T-shirt Grey for instructional duties, or with collared shirt for administrative duties.
- (k) Only to be worn when conducting activities involving swimming. Female PTIs are also entitled to wear, at their own expense, a plain black, navy blue or dark green two-piece sports/triathlon swimming costume. This includes a crop-top and *'boy shorts'* or *'speedo'* type bathers.

AL5

OFFICIAL

ADM

OFFICIAL

5K-7

Figure 5K-3: Physical Training Dress, with Cap Kept



AL5

OFFICIAL

Figure 5K-4: Physical Training Dress, with Top, Athletic Track



ADM

OFFICIAL

5K-9

Figure 5K-5: Physical Training Dress, with Suit, Athletic Track



AL5

OFFICIAL

Figure 5K-6: Physical Training Dress, with suit, Inclement Weather



ADM

OFFICIAL

5K-11

Figure 5K-7: Physical Training Dress, with T-shirt grey



AL5

OFFICIAL

ADM

OFFICIAL

5K-12

Figure 5K-8: Battle Physical Training Dress



AL5

OFFICIAL

OFFICIAL

ADM

5K-13

Figure 5K-9: Battle Physical Training Dress, top track athletic



AL5

OFFICIAL

OFFICIAL

ADM

5K-14

Figure 5K-10: Battle Physical Training Dress, jacket inclement weather



AL5

OFFICIAL

Figure 5K-11: Battle Physical Training Dress with runners



DRESS ORDER NO PT 2 ‘COMBAT FITNESS LEADER/ADF FITNESS LEADER—PHYSICAL TRAINING DRESS’

10. This order of dress is only to be worn by qualified CFL or ADF FL personnel when engaged in PT instructional or administrative duties. Garments are worn as appropriate to the activity being performed. It consists of the following items of dress:

Table 5K-3: Dress Order No PT 2 ‘Combat Fitness Leader/ ADF Fitness Leader—Physical Training Dress’

| Serial | Item of Dress | Remarks |
|--------|--|----------|
| 1 | Cap legionnaires green | Note (a) |
| 2 | Shirt gymnasium | Note (b) |
| 3 | Shorts athletic black lined with or without embroidered Australian Army Rising Sun badge on black background | |
| 4 | Socks athletic white or black | |
| 5 | Shoes gymnasium or shoes running | |

Notes:

- (a) The cap must be worn at all times out doors when carrying out instructional duties as required. The Hat KFF is not to be worn with PT Dress. If the Hat KFF is required to be worn, CFL/ADF FL is to change into the appropriate dress.
- (b) The T-shirt is to be worn when performing instructional or administrative duties. It is not to be worn in messes.
- (c) This T-shirt and Logo is currently under review as part of the PTI clothing project. Until this project is complete both CFL and ADF FL qualified personnel are authorised to wear this shirt and logo.

Figure 5K-12: Dress Order No PT 2 'Combat Fitness Leader/ADF Fitness Leader—Physical Training Dress'



Figure 5K-13: Dress Order No PT 2 'Combat Fitness Leader/ADF Fitness Leader—Physical Training Dress'



ADM

UNCLASSIFIED

AL5

UNCLASSIFIED

MEDICAL, DENTAL AND NURSING WORKING DRESS

GENERAL

1. This annex details the Working Dress and Protective Dress requirements for medical, dental and nursing personnel employed in a hospital ward, medical centre, barracks regimental aid post, dental surgery and laboratory environments.

WEARING AND POSITIONING OF EMBELLISHMENTS

The only embellishments worn with medical, dental and nursing Working Dress are embroidered badges of rank and embroidered name tags. No embellishment is worn on coats protective.

ORDERS OF DRESS

Table 5L: Dress Order No CD1 Clinical Dress

| Serial | Item of Dress | Remarks |
|--------|-------------------------|--|
| 1 | Gown Green | Note (a) (e) |
| 2 | Undershirt (round neck) | Note (b) |
| 3 | Trousers AMCU | Note (c) |
| 4 | Boots combat | |
| 5 | Socks Khaki | |
| 6 | Rank insignia AMCU | |
| 7 | Sign ANF patch | Note (d) Low visibility when in field hospital |
| 8 | Name tag AMCU | |

Notes:

- (a) Not to be worn outside of clinical areas. To be replaced with Shirt AMCU when outside of clinical areas
- (b) T-shirt green, Army Logo green T-shirt or purchased prescribed coloured T-shirt must be worn if the Gown Green shirt is removed. The T-shirt green, Army logo green T-shirt or purchased prescribed coloured T-shirt is to be tucked in at all times, IAW [Chapter 3](#)
- (c) As an alternative form of dress, Trouser AMCU Combat maybe worn.
- (d) The ANF patch and FSP/trade qualification patch/ identification arm patch is to be worn, IAW [Chapter 3](#). The USP is not worn with this order of dress.
- (e) Clinical dress must be laundered daily.

Figure 5L-1: Dress Order No CD 1 'Clinical Dress'



Figure 5L-2: Dress Order No CD 1 'Clinical Dress'



MILITARY POLICE DRESS

MILITARY POLICE EMBELLISHMENTS AND ACCOUTREMENTS

Military Police brassard/identification arm patch

1. MP brassards and identification arm patch are a form of identification for MP and as such, are to be worn when performing MP roles and tasks in uniform. They are worn with RACMP orders of dress and the design of the MP identification arm patch is in [Chapter 3](#). The MP brassard is worn in accordance with (IAW) [Chapter 3](#).

Royal Australian Corps of Military Police beret

2. The RACMP scarlet beret is worn by qualified personnel, IAW [Chapter 3](#).

General Duty Dress (Australian Multi-cam Camouflage Uniform) and Field Dress (Australian Multi-cam Camouflage Uniform)

3. When wearing General Duty Dress (AMCU) the scarlet MP identification arm patch is worn. When wearing Field Dress (AMCU) the drab green, low visibility MP identification arm patch is worn.

ORDERS OF DRESS

4. The orders of dress for RACMP personnel are in Table 5M-1.

Table 5M-1: Orders of Dress

| Dress Number | Dress Order Title | Table |
|--------------|--|-------|
| MP 1 | RACMP Patrol Order General Duty Dress (polyesters) | 5M-2 |
| MP 2 | RACMP Patrol Order Service Dress | 5M-3 |
| MP 3 | RACMP Patrol Order General Duty Dress (DPCU) | 5M-4 |

DRESS ORDER NO MP 1 'RACMP PATROL ORDER GENERAL DUTY DRESS (POLYESTERS)'

5. This order of dress is to be worn by MPs when General Duty Dress (polyesters) is required. It consists of the following items of dress:

Table 5M-2: Dress Order No MP 1 'Royal Australian Corps of Military Police Patrol Order General Duty Dress (polyesters)'

| Serial | Item of Dress | Remarks |
|--------|--|--------------|
| 1 | Australian Army Rising Sun Badge embroidered on khaki background | |
| 2 | Badge AIRN | If qualified |

| Serial | Item of Dress | Remarks |
|--------|--|---|
| 3 | Badge commendation or soldiers medallion | If awarded |
| 4 | Badge ACB/ICB/MIB/RIB | If presented/awarded |
| 5 | Belt white and belt hooks | |
| 6 | Belt Sam Browne and shoulder strap | Note (a) |
| 7 | Beret RACMP with appropriate hat badge | Note (b) |
| 8 | Brassard polyester MP | Complete with rank. |
| 9 | Emblems of unit citation and/or awards | If awarded |
| 10 | Hat KFF with appropriate hat badge | Brim down during prolonged outdoor duties |
| 11 | Holster pistol | Note (c) |
| 12 | Lanyard and appropriate insignia shoulder | |
| 13 | Nameplate | |
| 14 | Patent leather black boots, Black shoes, black Court shoes or R.M. Williams elastic sided, black leather boots | Notes (d) and (e) |
| 15 | Pouch handcuff/ASP tactical baton/OC spray white | Note (f) |
| 16 | Rank insignia | |
| 17 | Ribbons of orders, decorations and medals | If awarded |
| 18 | Shirt khaki short sleeve polyester | |
| 19 | Skirt polyester | |
| 20 | Slacks polyester | |
| 21 | Socks khaki | |
| 22 | Trade/skill qualification badge | Note (g) |
| 23 | Trousers polyester | |

Notes:

- (a) ADJTs and RSMs are to wear the Sam Browne Belt, IAW [Chapter 3](#).
- (b) Berets are to be worn, IAW [Chapter 3](#).
- (c) Worn for the purpose of MP duties, when ordered.
- (d) Patent leather black boots or the issued R.M. Williams elastic sided, black leather boots may be worn when with ceremonial orders of dress (on parade), General Duty Dress (polyesters), General Duty Service Dress and mess dress orders of dress.
- (e) When trousers are worn, women can either wear Court shoes or the issued R.M. Williams elastic sided, black leather boot.
- (f) Worn when ordered to carry handcuffs and/or ASP tactical baton.
- (g) Only worn by those qualified members, IAW [Annex 40](#).

Figure 5M-1: Dress Order No MP 1 'Royal Australian Corps of Military Police Patrol Order General Duty Dress (polyesters)'

TBA

AL5

DRESS ORDER NO MP 2 'ROYAL AUSTRALIAN CORPS OF MILITARY POLICE PATROL ORDER SERVICE DRESS'

6. This order of dress is only to be worn whilst carrying out MP patrol duties when Service Dress is required. It consists of the following items of dress:

Table 5M-3: Dress Order No MP 2 'Royal Australian Corps of Military Police Patrol Order Service Dress'

| Serial | Item of Dress | Remarks |
|--------|--|--|
| 1 | Australian Army Rising Sun Badge embroidered on khaki background | |
| 2 | Armlet MP | |
| 3 | Badge AIRN | If qualified |
| 4 | Badge commendation or soldiers medallion | If awarded |
| 5 | Badge ACB/ICB/MIB/RIB | If presented/awarded |
| 6 | Belt Sam Browne and shoulder strap | Note (a) |
| 7 | Beret RACMP with appropriate hat badge | Note (b) |
| 8 | Emblems of unit citation and/or awards | If awarded |
| 9 | Hat KFF with appropriate hat badge | Brim down during prolonged outdoor duties |
| 10 | Holster pistol | Note (c) |
| 11 | Jacket Service dress | Line 40 Australian Army Rising Sun buttons |
| 12 | Lanyard, collar badges and insignia shoulder, 'AUSTRALIA' | |
| 13 | Nameplate | |
| 14 | Necktie khaki polyester | |
| 15 | Patent leather black boots, Black shoes, black Court shoes or R.M. Williams elastic sided, black leather boots | Notes (d) and (e) |
| 16 | Patrol belt white | |
| 17 | Pouch handcuff/ASP tactical baton/OC spray white | Note (f) |
| 18 | Rank insignia | Officer rank to be pinned to epaulette |
| 19 | Ribbons of orders, decorations and medals | If awarded |
| 20 | Shirt khaki polyester long sleeve | |
| 21 | Skirt Service dress | |
| 22 | Slacks Service dress | |
| 23 | Socks khaki | |
| 24 | Trade/skill qualification badge | Note (g) |
| 25 | Trousers Service dress | |

Notes:

- (a) ADJTs and RSMs are to wear the Sam Browne Belt, IAW [Chapter 3](#).
- (b) Berets are to be worn, IAW [Chapter 3](#).
- (c) Worn for the purpose of MP duties, when ordered.
- (d) Patent leather black boots or the issued R.M. Williams elastic sided, black leather boots may be worn when with ceremonial orders of dress (on parade), General Duty Dress (polyesters), General Duty Service Dress and mess dress orders of dress.
- (e) When trousers are worn, women can either wear Court shoes or the issued R.M. Williams elastic sided, black leather boot.
- (f) Worn when ordered to carry handcuffs and/or ASP tactical baton.
- (g) Only worn by those qualified members, IAW [Annex 4O](#).

Figure 5M-2: Dress Order No MP 2 ‘Royal Australian Corps of Military Police Patrol Order Service Dress’

TBA

DRESS ORDER NO MP 3 ‘ROYAL AUSTRALIAN CORPS OF MILITARY POLICE PATROL ORDER GENERAL DUTY DRESS (AUSTRALIAN MULTICAM CAMOUFLAGE UNIFORM)’

7. This order of dress is only worn whilst carrying out MP patrols in barracks. It consists of the following items of dress:

Table 5M-4: Dress Order No MP 3 ‘Royal Australian Corps of Military Police Patrol Order General Duty Dress (Australian Multi-cam Camouflage Uniform)’

| Serial | Item of Dress | Remarks |
|--------|--|---|
| 1 | Australian Army Rising Sun Badge embroidered on AMCU background | |
| 2 | Boots combat | |
| 3 | Brassard/identification arm patch | Low visibility MP patch |
| 4 | Beret RACMP with appropriate hat badge | Note (a) |
| 5 | AMCU General Purpose jacket | AMCU rank slide |
| 6 | Hat KFF with UCP with appropriate hat badge | Brim down during prolonged outdoor duties |
| 7 | Holster pistol | Note (b) |
| 8 | Shirt AMCU | Notes (c) and (d) |
| 9 | Issued T-Shirt green, Army logo green T-shirt or purchased prescribed colour T-shirt | Note (e) |
| 10 | Name tag AMCU | |
| 11 | Patrol belt black | |
| 12 | Pouch handcuff/ASP tactical baton/OC spray black | Note (f) |
| 13 | Rank insignia AMCU | |

| Serial | Item of Dress | Remarks |
|--------|---|--|
| 14 | Sign ANF patch and USP/Trade qualification patch/Identification arm patch | High visibility only ^{Note (g)} |
| 15 | Socks khaki | |
| 16 | Trousers AMCU field | Note (h) |
| 17 | Wet weather ensemble | Optional |

Notes:

- (a) Berets are to be worn, IAW [Chapter 3](#).
- (b) Worn for the purpose of MP duties, when ordered.
- (c) Sleeves are to be worn down and buttoned and/or fastened with velcro.
- (d) The shirt is to be worn outside the trousers. If the shirt is required to be tucked in, a pistol belt is to be worn, with the exception of recruits at training establishments who may, as required by the CO, wear black belts. Black belts may be ordered for training.
- (e) T-shirt green, Army Logo green T-shirt or purchased prescribed coloured T-shirt must be worn if the AMCU shirt is removed. The T-shirt green, Army logo green T-shirt or purchased prescribed coloured T-shirt is to be tucked in at all times, IAW [Chapter 3](#).
- (f) Worn when ordered to carry handcuffs and/or ASP tactical baton.
- (g) The ANF patch and USP/trade qualification patch/identification arm patch is to be worn, IAW [Chapter 3](#).
- (h) Trousers are bloused over boots.

Figure 5M-3: Dress Order No MP 3 'Royal Australian Corps of Military Police Patrol Order General Duty Dress (Australian Multi-cam Camouflage Uniform)'

TBA

CATERING TRADE DRESS

GENERAL

1. Protective Dress for personnel employed in the catering trades is to be worn, in accordance with (IAW) this annex.

ITEMS OF DRESS

Apron

2. The apron is a lightweight protective garment worn over all Protective Dress when working in the kitchen and/or dining room environment, and is to be worn at full length. The apron is to be worn by all AACC personnel or other personnel employed in the preparation of food. The apron is to be worn whilst undertaking meal service outside the Mess environment.
3. The black apron is also to be worn in the field environment.

Cook jacket, white

4. The cook jacket white is a lightweight jacket with a bib front, long sleeves and white buttons. The jacket is to be worn with the right bib over left. Cook jacket white is to be worn by all cooks. The jacket is not to be worn in the field environment.
5. The jacket sleeves are to be ironed flat with no crease down the centre of the sleeve. The jacket is worn with a neckerchief. Cook jacket white is not worn by officers.

Footwear, cooks

6. All cooks are to wear Safety Boots fawn, protective cap while working in the Mess environment. Trousers are not to be bloused when Safety Boots are worn.

Headdress

7. The cook hat or cap black is to be worn by all cooks when wearing Protective Dress in the kitchen environment. They are also to be worn whilst undertaking meal service outside the Mess environment. The Hat KFF or beret is to be worn outside the barracks kitchen environment.

ORDERS OF DRESS

8. The orders of dress worn by personnel employed in the catering trades are in Table 5N-1.

Table 5N-1: Orders of Dress

| Dress Number | Dress Order Title | Table |
|--------------|----------------------|-------|
| CT 1 | Catering Dress, Cook | 5N-2 |

DRESS ORDER NO CT 1 'CATERING DRESS, COOK'

9. This order of dress is to be worn by all cooks. It consists of the following items of dress:

Table 5N-2: Dress Order No CT 1 'Catering Dress, Cook'

| Serial | Item of Dress | Remarks |
|--------|--|-------------------|
| 1 | Australian Army Rising Sun Badge embroidered on white background | |
| 2 | Apron cook black | Note (a) |
| 3 | Belt black 32 mm | |
| 4 | Beret Corps/Regiment/Unit with appropriate hat badge | Note (b) |
| 5 | Boots safety fawn, protective cap | Note (c) |
| 6 | Cook jacket white | Notes (d) and (e) |
| 7 | Cap cook black | Notes (c) and (d) |
| 8 | Hat KFF with appropriate hat badge | Note (f) |
| 9 | Name tag with white background | |
| 10 | Neckerchief white | |
| 11 | Rank insignia | |
| 12 | Socks khaki | |
| 13 | Trade/skill qualification badge | Note (g) |
| 14 | Trousers cook check | Notes (h) and (i) |

Notes:

- (a) Apron is to be worn at full length, IAW [Defence Safety Manual \(SafetyMan\)](#)²⁵.
- (b) Berets are to be worn, IAW [Chapter 3](#).
- (c) Worn at all times while in the kitchen and field environment.

²⁵ <http://drnet/People/WHS/WHS-Governance-Legislation-and-Policy/Pages/WHS-Manual.aspx>

OFFICIAL

ADM

5N-3

- (d) Worn at all times when employed in food preparation and/or service.
- (e) Buttons are to be white.
- (f) Not worn when preparing or serving food. Worn when outdoors within the barracks environment.
- (g) Only worn by those qualified members, IAW [Annex 4O](#).
- (h) Worn by all ranks, except officers.
- (i) Trousers are to be worn un-bloused, IAW [SafetyMan](#).

AL5

OFFICIAL

Figure 5N-1: Dress Order No CT 1 'Catering Dress, Cook'



MESS DRESS

INTRODUCTION

1. The CA approved the Re-introduction into service – Army's Corp Coloured Mess Dress 6A and 6B to replace the existing mess dress orders of 6D.
2. Dress Order 6D will continue to be worn by members until their current issued mess dress 6D has been re-issued for those entitled (Senior Officers, Officers, Tier C RSMs and SNCOs who have previously received an initial free issue of the All Seasons Mess Dress). Dress Order 6B will be issued to all entitled members, both ARA and ARes on initial promotion or commission from December 2020 as an initial free issue.
3. ARA members who have already received their initial issue of Dress Order No 6A or 6B and replaced it with Dress Order 6C or 6D will need to purchase 6A or 6B using uniform allowance.
4. The positioning of embellishments and the wearing of Dress Order No 6C and 6D is in Appendix 5O1. All trade, parachute, aircrew, parachute instructor and military skills badges for Mess Dress No 6C and 6D is in Appendix 5O2. The positioning of embellishments and the wearing of Dress Order No 6A and Mess Dress Order No 6B is in Appendix 5O3. Appendix 5O3
5. Dress Order No 6A, 6B 6C and 6D are to be worn for formal Mess functions and other occasions of a formal nature when the wearing of those orders of dress is appropriate. Those occasions are considered to be when the wearing of decorations is appropriate and civilian guests would be expected to wear a dinner suit. The tables detailing the requirements for mess dress orders of dress is in Chapter 5. The positioning of embellishments and the wearing of Dress Order No 6C and 6D is in [Appendix 5O1](#). All trade, parachute, aircrew, parachute instructor and military skills badges for Mess Dress No 6C and 6D is in [Appendix 5O2](#). The positioning of embellishments and the wearing of Dress Order No 6A and Mess Dress Order No 6B is in [Appendix 5O3](#). [Appendix 5O3](#) will be removed once the transition to the new Mess Dress is complete.

DEFINITIONS

6. The Mess Dress is to be referred to using the dress numbers below and designed to be worn throughout the year if the occasion warrants the wearing of mess dress orders of dress. The terminology used for mess dress orders of dress is as follows:
 - a. **Dress Order No 6A 'Mess Dress Army'**. This order of dress is worn by all officers to LTCOL rank.
 - b. **Dress Order No 6B 'Mess Dress Army'**. This order of dress is worn by all officers, WOs and SNCOs from SGT to LTCOL rank, excluding RSM-A and Tier C RSMs.

- c. **Dress Order No 6C 'Senior Ranks Mess Dress'**. This order of dress is worn by all Senior Officers, COL and above, RSM-A and Tier C RSMs with the following exceptions:
- (1) Initially on promotion to COL, an officer may continue to wear their current issued Mess Dress without Corps collar badges, but with badges of rank and other embellishments, until the Senior Ranks Mess Dress is issued.
 - (2) A senior General Staff Officer in a Corps appointment, ie HOC/HOR, when performing the duties of HOC/HOR, may wear the Senior Ranks Mess Dress with Corps embellishments.
- d. **Dress Order No 6D 'Mess Dress Army'**. This order of dress is worn by all officers, WOs and SNCOs from SGT to LTCOL rank, excluding RSM-A and Tier C RSMs.

PROCEDURE ON PROMOTION/CORPS TRANSFER

7. If a member is promoted, with the exception of the promotion to a Senior officer, RSM-A or an appointment as a Tier C RSM, there is no entitlement to a replacement Mess Dress after the initial issue. On approval of a promotion, the member is issued replacement rank boards for their new rank. On promotion to Senior officer, RSM-A, or an appointment as a Tier C RSM, the member is entitled to the issue of the Senior Ranks Mess Dress.
8. If a member Corps transfers, there is no entitlement to a replacement Mess Dress. On approval of the Corps transfer, the member will be issued the Corps badges and cummerbund for their new Corps. Members are to arrange for issue of the correct badges for their new rank and/or Corps. Once approved, members are not to wear the badges of their previous Corps.

ITEMS OF DRESS

Aiguillette

9. The aiguillette is worn by entitled members, IAW [Chapter 3](#).

Black bow tie

10. Only a plain black bow tie is worn with all mess dress orders of dress. The bow tie is to be made of black satin or a similar synthetic material, with square ends not more than 58 mm or less than 56 mm wide.

Braces

11. If braces are worn with mess dress orders of dress, they are to be white with chrome fixtures.

Buttons

12. The Mess Dress jacket is designed appropriate to Corps with a button hole at the front of the jacket on each side to hold the jacket closed. A gold or silver line 30 Australian Army Rising Sun button is to be worn by SGT to BRIG rank and General's buttons for MAJGEN and above rank. RSM-A and Tier C RSM are to wear the gold line 30 Rising Sun button. The buttons are to be secured with a gold or silver chain, appropriate to Corps.

Cufflinks

13. Plain gold or silver cufflinks, appropriate to Corps, are to be worn on each cuff of the Marcela white dress shirt worn with all mess dress orders of dress. Members are permitted to wear gold or silver cufflinks, which have motifs such as, Corps insignia inscribed in gold or silver, appropriate to Corps. RSM-A and Tier C RSMs are to wear gold cufflinks with the Australian Army Rising Sun motif. They are not provided at Commonwealth expense. Plain cufflinks are to be purchased from area clothing stores.

Cummerbund

14. The cummerbund worn with mess dress orders of dress is made of satin, or a similar synthetic material, and Corps colour is to be IAW column (g) in Table 5O-1 and column (c) in Table 5O-2, with the exception of CO 1 RAR, who is to wear a garter blue cummerbund.

Table 5O-1: Patterns of Mess Dress – Senior Ranks Mess Dress and Mess Dress Army

| Serial (a) | Corps (b) | Jacket Body (c) | Jacket Collar (d) | Jacket Shoulder (e) | Jacket Cuffs (f) | Jacket Cummerbund (g) |
|------------|---|-----------------|-------------------|---------------------|-----------------------|-----------------------|
| 1 | Senior Ranks Mess Dress (COL-GEN, RSM-A and Tier C RSM) | Scarlet | Black | Black | Black | Black |
| 2 | Mess Dress Army (SGT-LTCOL) | Black | Black | Black | Black with red piping | Appropriate to Corps |

Table 5O-2: Patterns of Mess Dress

| Serial (a) | Corps (b) | Jacket Cummerbund (c) |
|------------|-----------------------|-----------------------|
| 1 | Corps of Staff Cadets | Scarlet |
| 2 | RAAC | Maroon |
| 3 | RAA | Blue-black |
| 4 | RAE | Scarlet |

| Serial (a) | Corps (b) | Jacket Cumberbund (c) |
|---------------|--------------|--------------------------|
| 5 | RA Sigs | Purple |
| 6 | RA Inf | Scarlet |
| 7 | AA Avn | Light blue |
| 8 | Aust Int | Bottle green |
| 9 | RAA Ch D | Black |
| 10 | RACT | Blue-black |
| 11 | RAAMC | Dull cherry |
| 12 | RAADC | Burnt orange |
| 13 | RAAOC | Scarlet |
| 14 | RAEME | Blue-black |
| 15 | RAAEC | Scarlet |
| 16 | AAPRS | Scarlet |
| 17 | AACC | Grey |
| 18 | RAAPC | Blue-black |
| 19 | AALC | Grey |
| 20 | RACMP | Scarlet |
| 21 | AA Psych | Blue-black |
| 22 | AABC | Scarlet |
| 23 | RAANC | Scarlet |

Footwear

15. Patent leather black boots, Black shoes, black Court shoes or R.M. Williams elastic sided, black leather boots may be worn with all mess dress orders of dress, IAW [Chapter 3](#).

Sash shoulder scarlet

16. The scarlet shoulder sash is to be worn by entitled members, IAW [Chapter 3](#).

Trousers, slacks and skirts

17. Mess Dress trouser and slacks width. The bottoms of the Mess Dress trousers and slacks are graduated, in proportion for seat and length of leg. The hems of the trousers are to rest on the top of the shoe or boot at the bottom lace or equivalent position.

18. Length of skirt. The hem of the skirt is to rest on the top of the toe of the shoe.

19. Mess Trousers stripe. The mess trouser stripe is a single scarlet stripe. For SGT to LTCOL, excluding RSM-A and Tier C RSMs, it is 2 cm in width. For those entitled to wear the Senior Ranks Mess Dress, the width of the stripe is 4 cm.

Shirts Mess Dress

20. The male or female white Marcella Mess Dress shirt is worn with Dress Order No 6A, 6C and 6D. The Marcella shirt is worn with gold or silver studs and matching cuff links as appropriate to Corps. A plain white shirt is worn with Dress Order No 6B.

Spurs

21. Box spurs may only be worn by RAAC Officers, WOs and SNCOs when wearing boots with mess dress orders of dress. The authorised spur to be worn is the Prince of Wales Spur design, IAW Figure 5O-1. Spurs are not provided at Commonwealth expense.

Figure 5O-1: Prince of Wales Spur



Studs

22. Four plain gold or silver studs, appropriate to Corps, are to be issued, and are to be worn on the front of the white Marcela Mess Dress shirt, when worn with the mess dress orders of dress. Plain studs may be purchased from area clothing stores.

23. Members may elect to wear gold or silver studs, appropriate to Corps, which has Corps specific motifs insignia inscribed in gold or silver. They are not provided at Commonwealth expense.

EMBELLISHMENTS OF MESS DRESS

24. The types of embellishment worn with Dress Order No 6C and 6D are as follows. The positioning of those items is in [Appendix 5O1](#).

25. Mess Dress Army is embellished as follows:

- a. **Army identification.** The Australian Army Rising Sun Badge is gold and red on a black background, in [Appendix 5O2](#), is worn on the top of the left sleeve of the jacket 1.5 cm below the shoulder seam, IAW [Appendix 5O1](#).

- b. **Retired member insignia.** The Retired Member Insignia is worn centrally on both sleeves of the jacket with the top edge 1 cm below the shoulder seam, above the Australian Army Rising Sun Badge and Trade Badges. The position of Retired Member Insignia is in [Appendix 5O1](#).
- c. **Trade badges.** A full size embroidered trade qualification badge on a black background, in [Appendix 5O2](#), is to be worn by eligible members on the right sleeve, 2 cm below the shoulder seam. If a member has more than one qualification, only one badge is to be worn. The badge of the members' current employment trade is worn. Where a member is not employed in a trade, the badge of the last employed trade is to be worn. The position of trade badges is in [Appendix 5O1](#).
- d. **Parachute badges.** A full size embroidered parachute badge, in [Appendix 5O2](#), is to be worn by eligible members on the right sleeve, 2 cm below the shoulder seam. With the exception of the 3 RAR and Commando badge, the parachute badge is on a black background. The 3 RAR badge is on a dull cherry background and the Commando badge is on a Sherwood green background. If a trade badge is also worn, the parachute badge is worn 1 cm below the trade badge. The position of parachute badges is in [Appendix 5O1](#).
- e. **Military skills badges.** Full size embroidered military skills badges, in [Appendix 5O2](#), on a black background may be worn by eligible members on the left sleeve, 1 cm below the Australian Army Rising Sun Badge. The position of military skills badges is in [Appendix 5O1](#).
- f. **Badges of rank.** Badges of rank, appropriate to Corps or unit, are worn on curved black hard shoulder boards by all officers, WOs and SNCOs. The position of badges of rank is in [Appendix 5O1](#). Badges of rank are issued already assembled and are to be worn on the epaulette by all ranks.
- g. **Collar badges.** Corps/Regiment or Special Appointment collar badges are worn in pairs on the collar/lapel of the Mess Dress jacket. Officers and SNCOs to and including LTCOL (excluding RSM–A, Tier C RSMs and members of the AFG), are to wear Corps/Regiment collar badges on the collar/lapel. RSM–A, Tier C RSMs and members of the AFG are to wear miniature metal Australian Army Rising Sun collar badges on the collar/lapel. The badges are positioned in the centre of the lower portion of the collar/lapel, with the base of the badge in line with the outer point of where the collar meets the lapel. Collar badges are worn by COL and above only when appointed as a HOC/HOR, and are attending in that role. The position of collar badges is in [Appendix 5O1](#).
- h. **Infantry Combat Badge and Army Combat Badge.** Entitled members are to wear the miniature ICB or ACB on the left lapel of the Mess Dress jacket. Only 1 badge is to be worn. The badge is positioned centrally with the highest point central and 1 cm below the 'V' formed where the collar meets the lapel. The position of the ICB and ACB badges is in [Appendix 5O1](#).
- i. **Aircrew and parachute instructor badges.** Miniature metal aircrew or PJI/FFI, PJI or PJM badges are to be worn by qualified members. Where a

member has more than one qualification only 1 badge is to be worn. The miniature aircrew, PJI/FFI, PJI or PJM badges are worn centrally on the left lapel, positioned with the highest point 1 cm below the miniature ICB/ACB. Where no ICB/ACB is worn, the badge is positioned with the highest point central and 1 cm below the 'V' formed where the collar meets the lapel. The position of the aircrew and parachute instructor badges is in [Appendix 5O1](#).

- j. **Orders, decorations and medals.** Mess Dress miniatures of official orders, decorations and medals are worn horizontally on the left lapel. The top of the miniature medals are positioned 1 cm below the bottom of the ICB/ACB or, if worn, 1 cm below the bottom of an aircrew/parachute instructor badge. Where no ICB/ACB or aircrew/parachute instructor badge is worn, the miniature medals are positioned horizontally 1 cm below the 'V' formed where the collar meets the lapel. Miniature medals are worn central to the lapel. Where the width of the medals exceeds the width of the lapel, the inside edge of the miniature medals is to be positioned against the inner edge of the lapel. When no emblems of unit awards are worn, miniatures of approved unofficial awards (i.e. Police Medal), may be worn on the right lapel in the same position as official awards. Neck decorations, when worn with the Mess Dress jacket, are suspended from the miniature ribbon of the order. The position of the medals is in [Appendix 5O1](#).
- k. **Service/Defence commendations and Soldiers medallions badge.** Miniature Service/Defence commendations and Soldiers Medallion Badge are worn on the right lapel. A maximum of four commendations may be worn. A single commendation is positioned with the highest point of the badge positioned centrally, and 1 cm below the 'V' formed where the collar meets the lapel. Where two commendations are worn, they are positioned horizontally either side of the centre line 5 mm apart. Where three commendations are worn, they are positioned horizontally with the outside commendations 5 mm either side of the centre commendation. Where four commendations are worn, the first commendation is positioned the same as a single commendation, the second, third and fourth commendations are positioned horizontally 1 cm below the first commendation, with the outside commendations 5 mm either side of the centre commendation. Multiple commendations are worn in order of seniority, IAW [Annex 4L](#). The position of the commendation badges is in [Appendix 5O1](#).
- l. **Emblems of unit citations and awards.** Miniature emblems of Unit citations and awards are worn on the right lapel. A maximum of four awards may be worn. The awards are worn in a single row. The award(s) is positioned central, with the highest point 1 cm below any individual commendation badge. Where no commendation badge is worn, the award(s) is positioned centrally and 1 cm below the 'V' formed where the collar meets the lapel. Where a member is entitled to wear an emblem of a unit award and a medal of an unofficial award, the ribbon of the unofficial award is to be worn on a separate row 3 mm below the unit award. The position of the unit awards is in [Appendix 5O1](#).
- m. **Royal Cypher and Crown insignia.** The small Royal Cypher and Crown Insignia are worn by entitled members on the collar of the jacket in the same

ADM

5O-8

manner and in place of Corps collar badges. The position of the Royal Cypher and Crown Insignia is in [Appendix 5O1](#).

- n. **Army Individual Readiness Notice badge.** The AIRN Badge is not worn with any Mess Dress jacket.
- o. **Recruit Instructor Badge/Military Instructor Badge.** The RIB/MIB is not worn with any Mess Dress jacket.

Appendices:

- 5O1 [Positioning of embellishments for Mess Dress Order No 6C and Mess Dress Order No 6D](#)
- 5O2 [Rising Sun, Trade, Parachute, Aircrew, Parachute Instructor and Military Skills Badges for Mess Dress Order No 6C and Dress Order No 6D](#)
- 5O3 [Mess Dress Order No 6A and Mess Dress Order No 6B](#)

POSITIONING OF EMBELLISHMENTS FOR MESS DRESS ORDER NO 6C AND MESS DRESS ORDER NO 6D

Figure 501-1: Positioning the trade qualification, rising sun, parachute and military skills badges

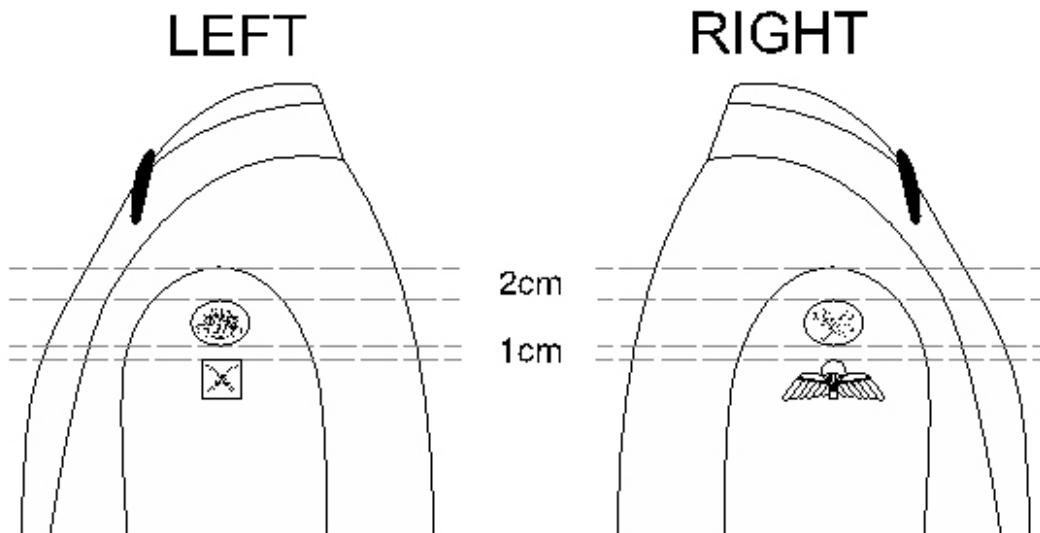

Figure 501-2: Positioning the retired member insignia badges

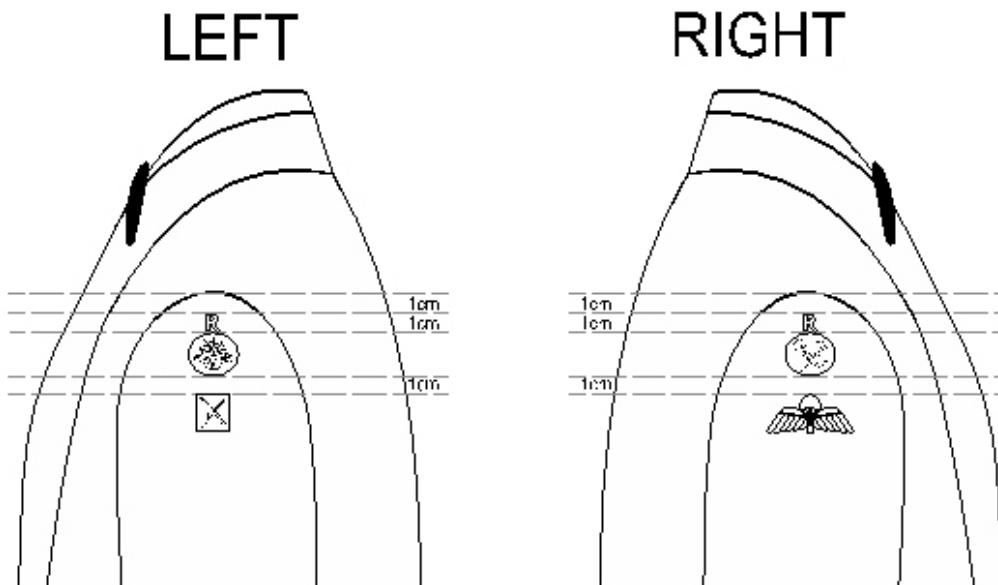

Figure 501-3: Positioning the Badges of Rank for Officers and Non-Commissioned Officers

TOP



TOP



Figure 501-4: Positioning the Collar Badges and Miniature Medals

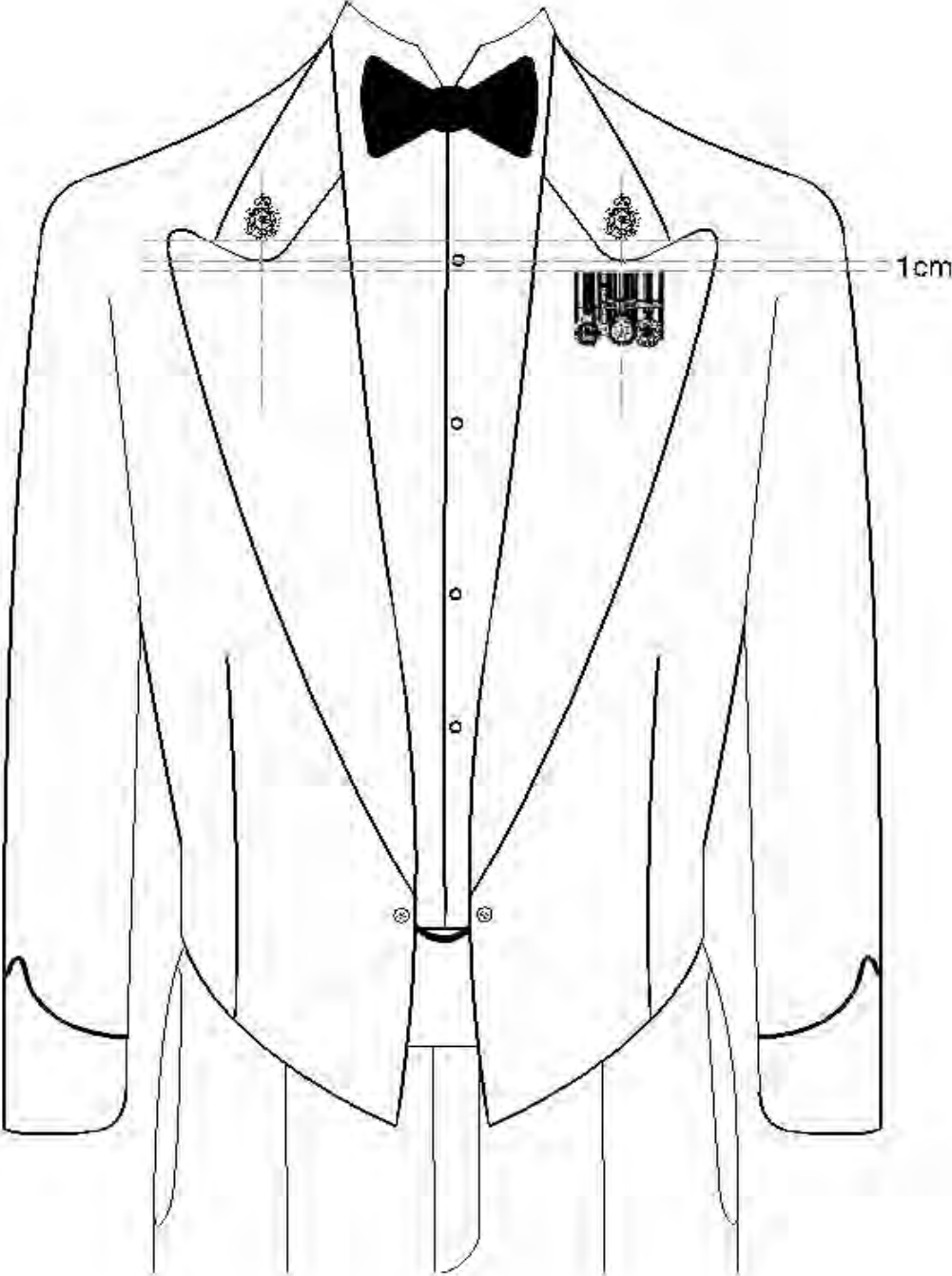

Figure 501-5: Positioning the Collar, Single Commendation and Infantry Combat Badges, Miniature Medals and Two Unit Citations

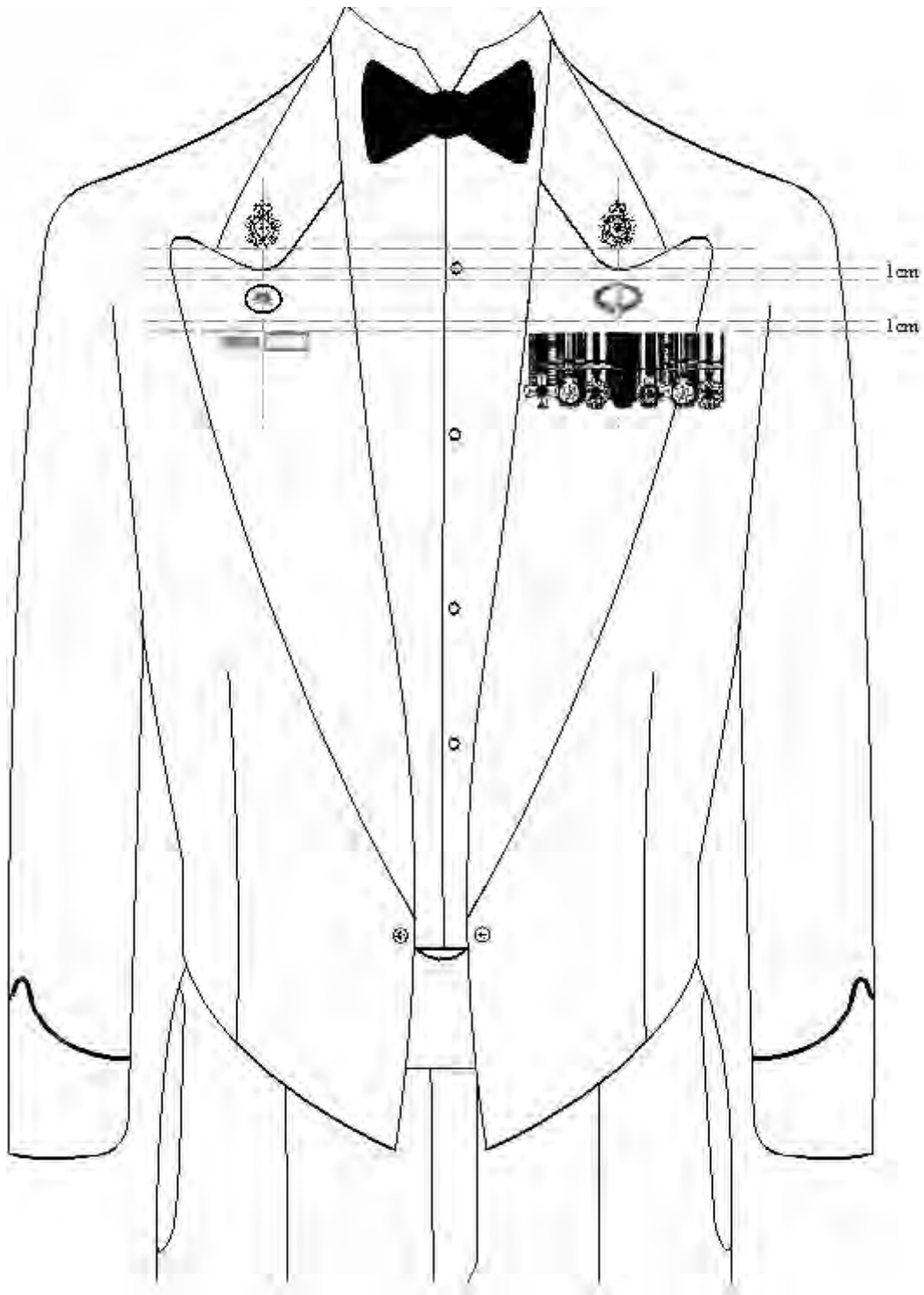

Figure 501-6: Positioning the Collar, Two Commendations, Infantry Combat Badge and Aircrew/Parachute Instructor Badges, Miniature Medals and Two Unit Citations

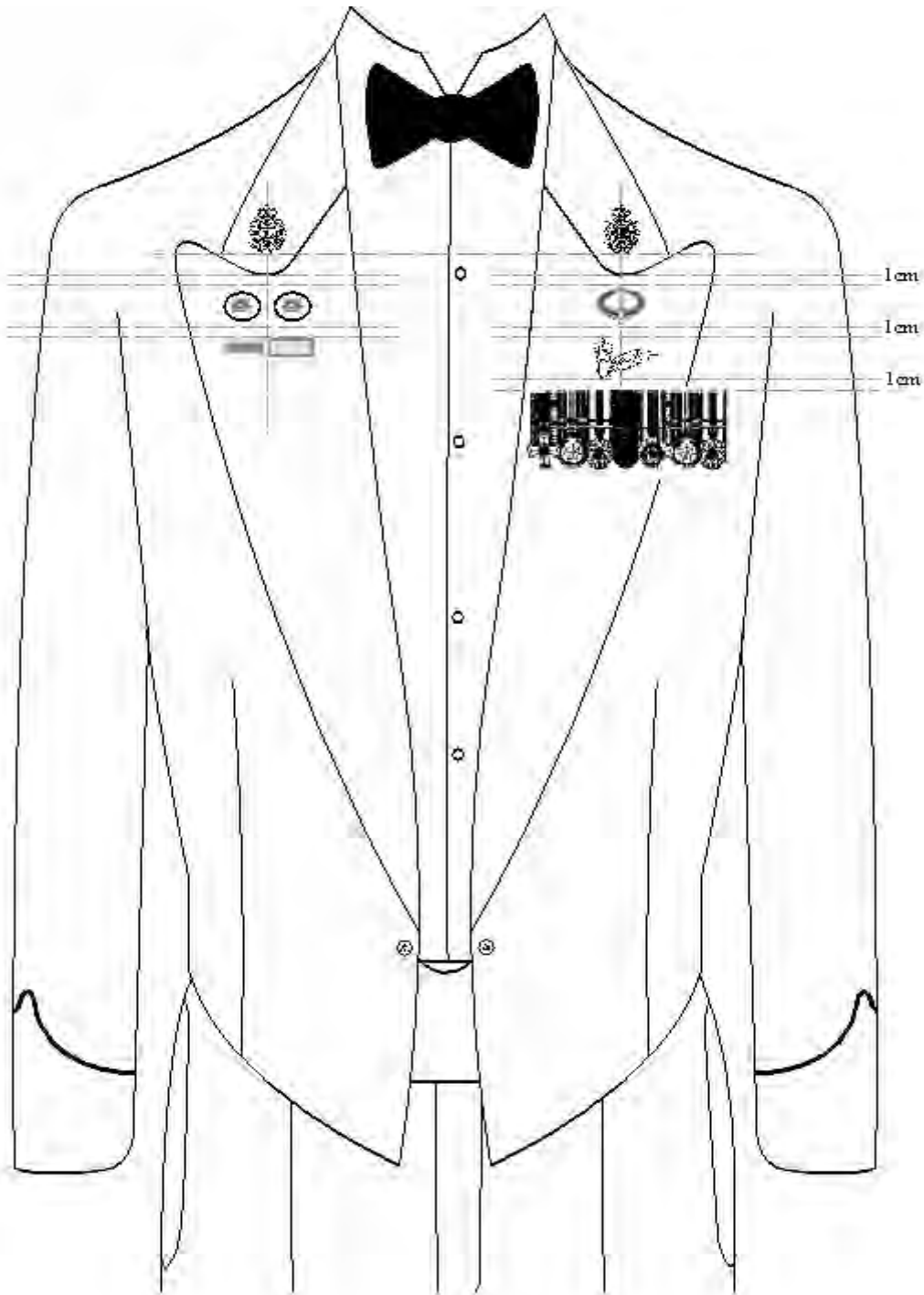

Figure 501-7: Positioning the Collar, Three Commendations, Infantry Combat Badge and Aircrew/Parachute Instructor Badges, Miniature Medals and Three Unit Citations

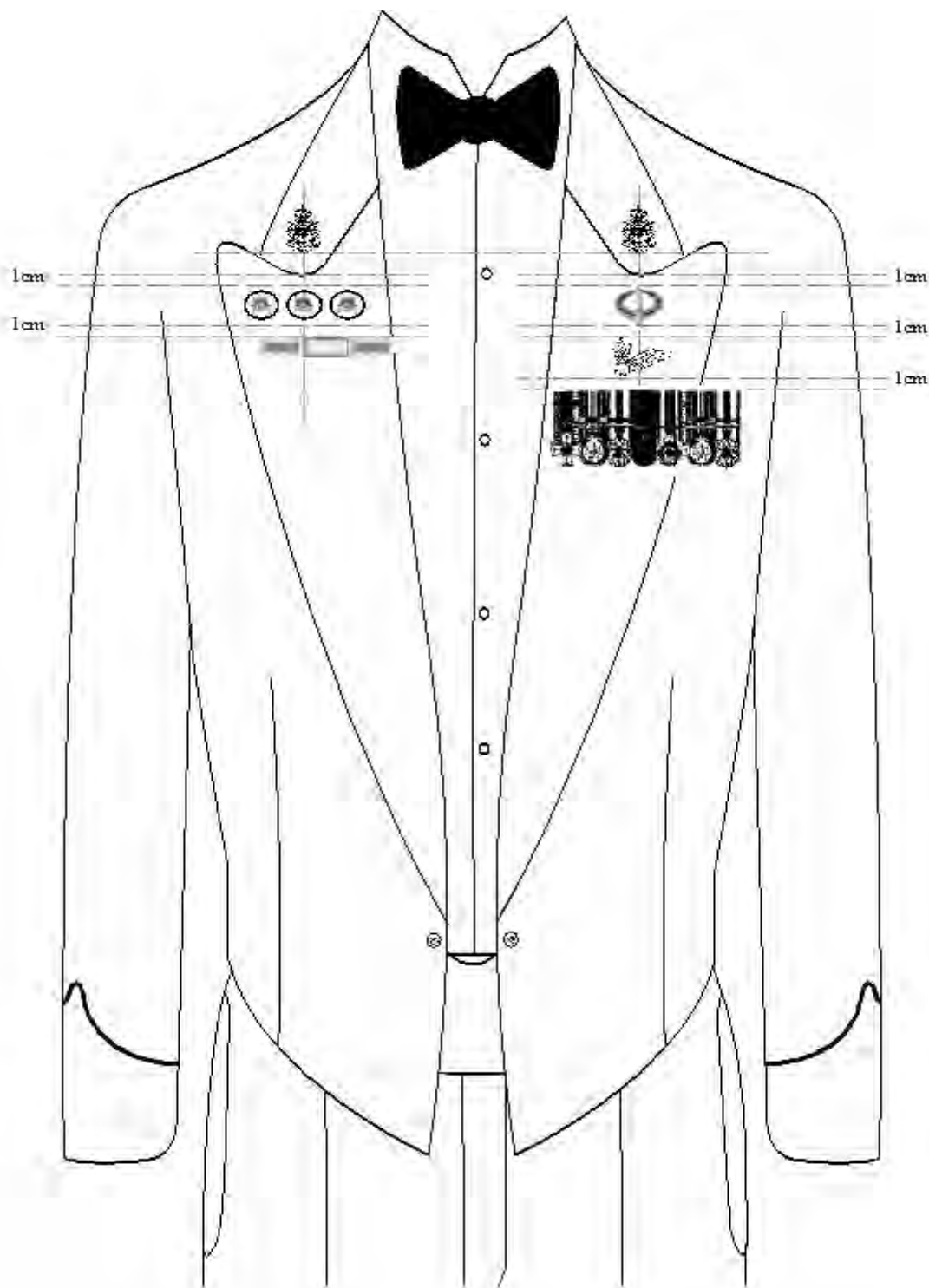

Figure 501-8: Positioning the Collar, Four Commendations, Infantry Combat Badge and Aircrew/Parachute Instructor Badges, Miniature Medals and Three Unit Citations

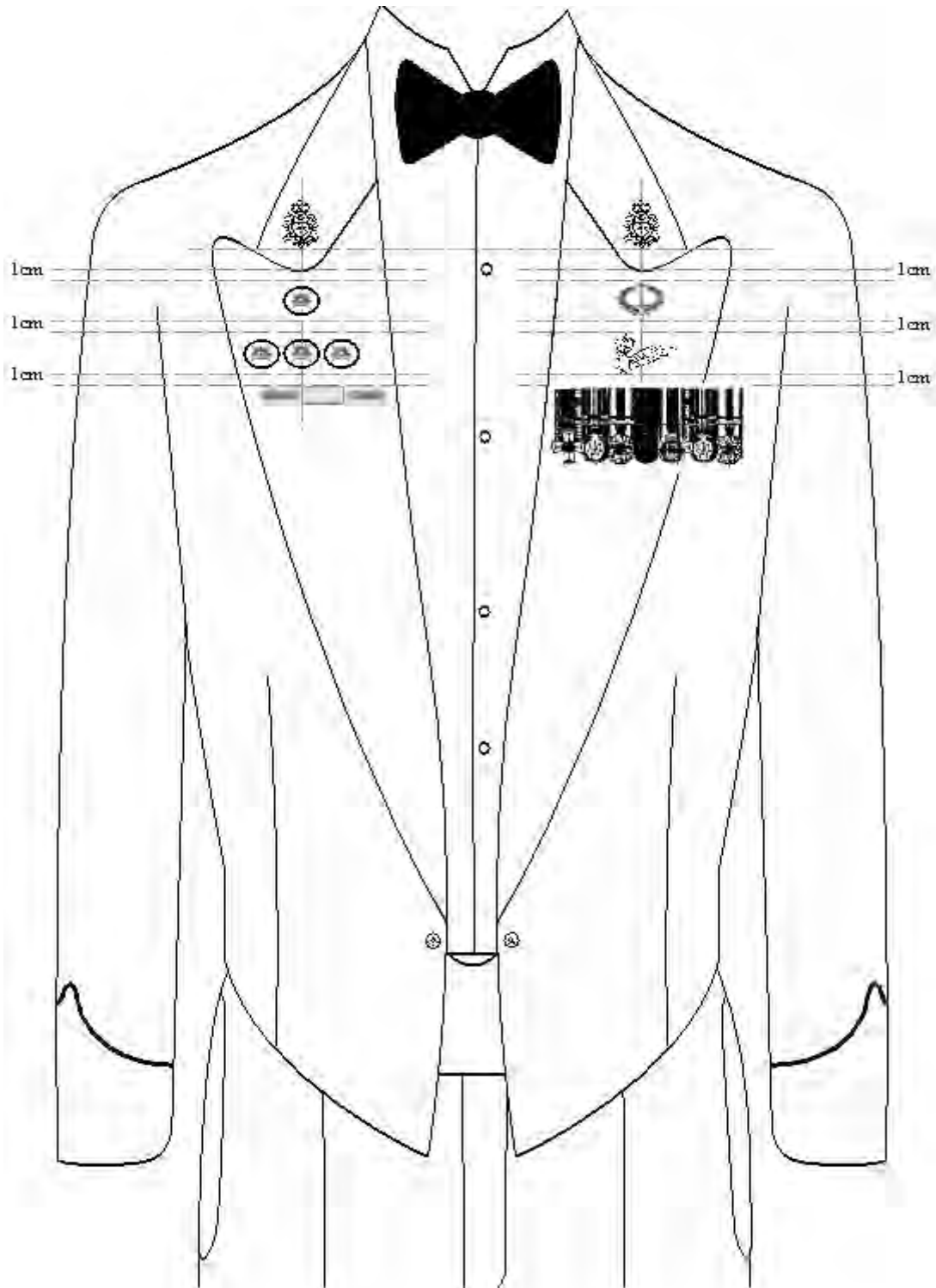

Figure 501-9: Positioning the Collar, Four Commendations, Infantry Combat Badge and Aircrew/Parachute Instructor Badges, Miniature Medals and Four Unit Citations

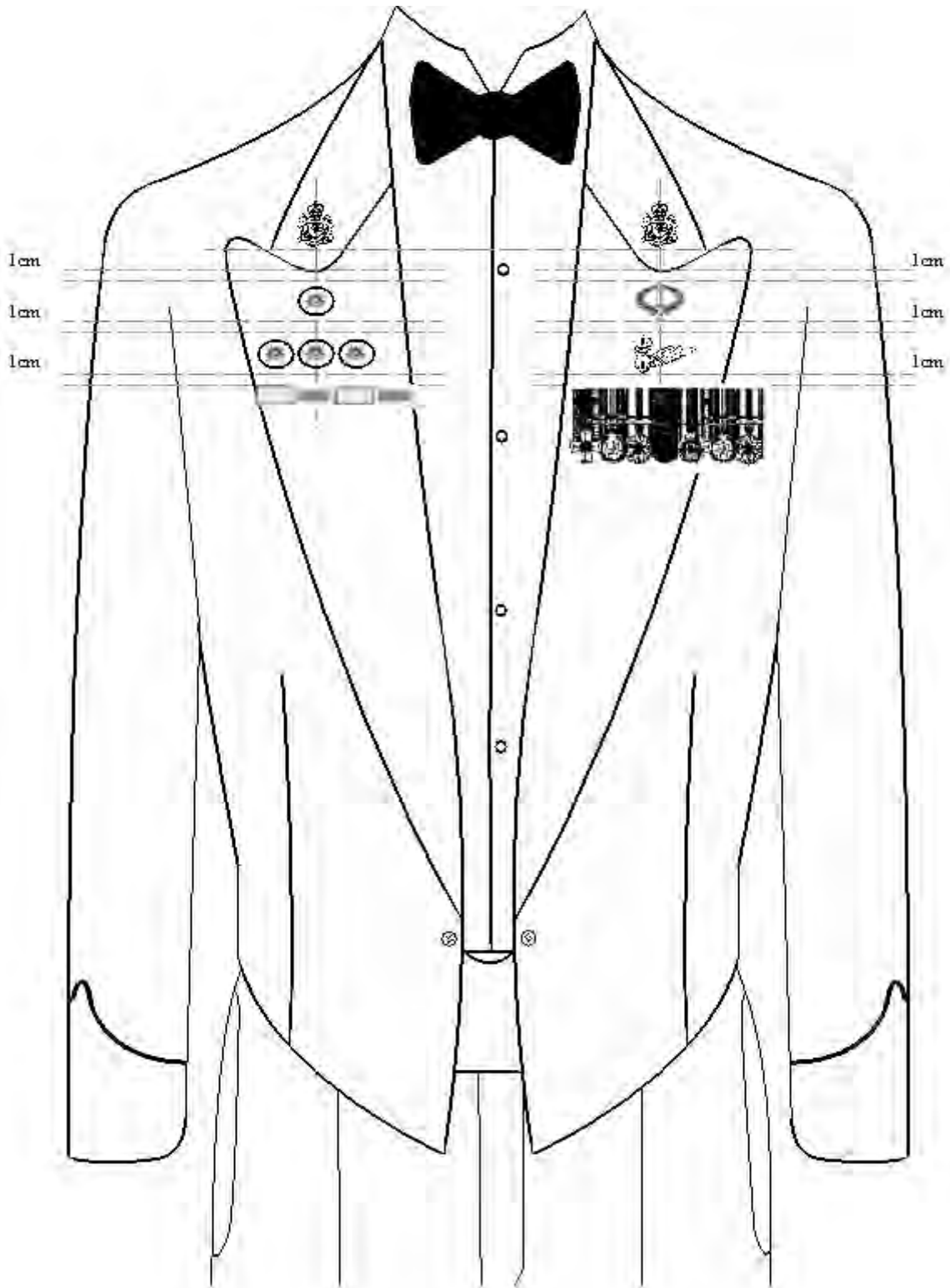

Figure 501-10: Positioning the Royal Cypher and Crown Insignia, Two Commendations, Infantry Combat Badge and Aircrew/Parachute Instructor Badges, Miniature Medals and Two Unit Citations



**RISING SUN, TRADE, PARACHUTE, AIRCREW,
PARACHUTE INSTRUCTOR AND MILITARY SKILLS
BADGES FOR MESS DRESS ORDER NO 6C AND DRESS
ORDER NO 6D**



| | | |
|---|---|---|
| 3 RAR Parachute Wings | Ammunition Technical Officer | Army Top 20 |
|  |  |  |
| Commando Parachute Wings | Explosives Ordnance Disposal | Skills at Arms |
|  |  |  |

| | | |
|---|--|---|
| Paratrooper Wings | Physical Training | Sniper |
|  |  |  |
| SASR Parachute Wings | Artificer | Emergency Response |
|  |  |  |
| Parachute Rigger | Operator Petroleum | Air Dispatcher |
|  |  |  |
| Drummer | Musician | Piper |
|  |  |  |
| Parachute Jump Instructor | Free Fall Instructor | Parachute Jump Master |
|  |  |  |

ADM

502-2

| | | |
|---|--|---|
| Army Pilot | Army Observer | Army Aircrewman |
|  |  |  |
| Army Test Engineer | Army Technician | |
|  |  | |

MESS DRESS ORDER NO 6A AND MESS DRESS ORDER NO 6B

Dress Orders 6A and 6B

This appendix applies to all members who have not yet purchased, or been issued, Dress Order No 6C or 6D. From January 2022 all members are to have been issued or purchased Dress Order No 6C or 6D.

GENERAL

1. Mess Dress or Mess Dress White Jacket are mess dress orders of dress for formal occasions. Those occasions are considered to be when the wearing of decorations is appropriate and civilian guests would be expected to wear dinner suit. Officers who are attending a dinner in the SGTs' Mess are to wear Mess Dress White Jacket regardless of season.

DEFINITIONS

2. The terminology used for the three orders of Mess Dress is as follows:
- Mess Dress.** This order of dress consist the jacket and waistcoat in Corps colours, worn by officers with blue trousers for males, and blue slacks or blue skirt for females.
 - Mess Dress White Jacket.** This order of dress consist the white mess jacket, worn with blue trousers for males, and blue slacks or blue skirt for females, and cummerbund by officers, WOs and SNCOs.
 - Mess Dress Senior Officer.** This order of dress is in [Annex 5C](#).
3. Mess Dress is sometimes referred to as 'Mess Dress Winter' and Mess Dress White Jacket as 'Mess Dress Summer' but this terminology is incorrect. Mess Dress may be worn throughout the year according to the occasion and climatic conditions. WOs and SNCOs have no alternative to Mess Dress White Jacket.

PROCEDURE ON CORPS TRANSFER

4. If an officer Corps transfers, the Mess Dress of the member's former Corps may continue to be worn until the Mess Dress of the new Corps is issued. All aspects of the Mess Dress are to be worn as for the former Corps; no order of 'hybrid' order of dress is to be worn.
5. There is no time limit imposed on the wearing of the previous Corps Mess Dress. Members are to be encouraged to arrange for issue of the correct Mess Dress for their new Corps as soon as possible.
6. Members who Corps transfer after December 2011, are required to replace Dress Order No 6A or 6B with either Dress Order No 6C or 6D, as appropriate to

rank. If a member has received their initial free issue, they are to purchase Dress Order No 6C or 6D using their uniform allowance.

ITEMS OF DRESS

Black bow tie

7. The black bow tie is worn with Mess Dress and Mess Dress White Jacket. The bow tie is to be made of silk, satin or a similar synthetic material, with the square ends not more than 58 mm or less than 25 mm wide.

Braces

8. If braces are worn with Mess Dress White Jacket, they are to be white with chrome fixtures.

Cufflinks

9. Cufflinks are worn on the cuffs of white dress shirts, when worn with Mess Dress and may be worn with white soft shirts, with Mess Dress White Jacket. They are to be either plain gold or plain silver and they may include motifs, such as initials or insignia inscribed in gold or silver appropriate to Corps. They are not provided at public expense.

Cummerbunds

10. The cummerbund when worn with Mess Dress White Jacket, is made of silk and is to be the same colour as the colour prescribed for the Mess Waistcoat in Table 503–1, column (g), with the following exceptions:

- a. a member of the RAA or RACT is to wear a blue-black cummerbund
- b. a member of the RAE is to wear a scarlet cummerbund
- c. RSM–A and Tier C RSMs are to wear black cummerbund
- d. a member of the Corps of Staff Cadets is to wear a scarlet cummerbund
- e. CO 1 RAR is to wear a garter blue cummerbund.

Footwear

11. Patent leather black boots, Black shoes, black Court shoes or R.M. Williams elastic sided, black leather boots may be worn with mess dress orders of dress, IAW [Chapter 3](#) and [Chapter 5](#).

Mess Dress jackets and waistcoats

12. The Mess Dress jacket is designed with a roll collar and epaulettes with rounded points attached by line-30 buttons. The waistcoat is worn with line-20 buttons, IAW [Chapter 3](#).

13. The colours and patterns of Corps mess jackets and waistcoats are in Table 503–1.

Table 503–1: Colours and patterns of Corps Mess Jackets and Waistcoats

| Serial (a) | Corps (b) | Jacket – Body (c) | Jacket – Collar (d) | Jacket – Shoulder (e) | Jacket – Cuffs (f) | Jacket – Waistcoat, Straps and Cummerbund (g) |
|------------|-------------|-------------------|---------------------|---------------------------|--------------------------------|---|
| 1 | Staff Corps | Scarlet | Black | Black ^{Note (a)} | Black | Black |
| 2 | RAAC | Maroon | Blue-black | Maroon | Blue-black | Maroon |
| 3 | RAA | Blue-black | Blue-black | Blue-black | Scarlet | Blue-black |
| 4 | RAE | Scarlet | Blue-black | Scarlet | Blue-black | Scarlet |
| 5 | RA Sigs | Scarlet | Purple | Purple | Purple | Purple |
| 6 | RA Inf | Scarlet | White | Scarlet | White | Scarlet |
| 7 | AA Avn | Blue-black | Blue-black | Blue-black | Blue-black ^{Note (b)} | Light blue |
| 8 | Aust Int | Scarlet | Bottle green | Black | Black | Bottle green |
| 9 | RAA Ch D | Blue-black | Purple | Purple | Purple | Black |
| 10 | RACT | Scarlet | Scarlet | Scarlet | Scarlet ^{Note (c)} | Blue-black |
| 11 | RAAMC | Blue-black | Dull cherry | Dull cherry | Dull cherry | Dull cherry |
| 12 | RAADC | Blue-black | Burnt orange | Burnt orange | Burnt orange | Burnt orange |
| 13 | RAAOC | Blue-black | Scarlet | Scarlet | Scarlet | Scarlet |
| 14 | RAEME | Blue-black | Scarlet | Blue-black | Blue-black ^{Note (d)} | Blue-black |
| 15 | RAAEC | Scarlet | University blue | Scarlet | University blue | Scarlet |
| 16 | AAPRS | Scarlet | Bottle green | Scarlet | Bottle green | Scarlet |
| 17 | AACC | Scarlet | Grey | Grey | Scarlet ^{Note (d)} | Grey |
| 18 | RAAPC | Blue-black | Gold | Blue-black | Blue-black | Blue-black |
| 19 | AALC | Scarlet | Grey | Grey | Grey | Grey |
| 20 | RACMP | Blue-black | Blue-black | Scarlet | Blue-black | Scarlet |
| 21 | AA Psych | Blue-black | Maroon | Maroon | Blue-black | Blue-black |
| 22 | AABC | Scarlet | Rifle green | Rifle green | Rifle green | Scarlet |
| 23 | RAANC | Scarlet | Scarlet | Scarlet | Scarlet | Scarlet |

Notes:

- (a) Edged with 1 cm gold lace (oak leaf pattern for General officers and staff pattern for BRIG and COL).
- (b) Edged with 3 mm silver bullion braid.
- (c) Edged with blue-black braided knot.
- (d) Edged with 3 mm gold bullion braid.
- (e) Edged with scarlet piping.

14. The Mess Dress White Jacket is similar in design, but it is worn without a waistcoat.

Mess Dress trousers, slacks and skirts

15. **Corps or regimental stripes.** The colour of stripes worn on blue trousers, blue slacks and blue skirts are in Table 503–2.

Table 503–2: Colours of stripes on Blue Trousers, Slacks and Skirts

| Serial | Corps or Group | Details of Stripe(s) – Colour | Details of Stripe(s) – Number of Stripes | Details of Stripe(s) – Width | Details of Stripe(s) – Distance Apart |
|--------|--------------------------|-------------------------------|--|------------------------------|---------------------------------------|
| 1 | General officers | Scarlet | 1 | 4 cm | |
| 2 | Principal Chaplain | Purple | 1 | 4 cm | |
| 3 | Staff Corps BRIG and COL | Scarlet | 1 | 4 cm | |
| 4 | Corps of Staff Cadets | Scarlet | 1 | 4 cm | |
| 5 | RSM–A and Tier C RSMs | Scarlet | 1 | 4 cm | |
| 6 | RAAC | Gold | 2 | 2 cm | 3 mm |
| 7 | RAA | Scarlet | 1 | 4 cm | |
| 8 | RAE | Scarlet | 1 | 4 cm | |
| 9 | RA Sigs | Scarlet | 1 | 4 cm | |
| 10 | RA Inf | Scarlet | 1 | 1 cm | |
| 11 | AA Avn | Light blue | 2 | 2 cm | 3 mm |
| 12 | Aust Int | Scarlet | 4 cm | | |
| 13 | RAA Ch D | Purple | 1 | 4 cm | |
| 14 | RACT | White | 2 | 2 cm | 3 mm |
| 15 | RAAMC | Dull cherry | 1 | 4 cm | |
| 16 | RAADC | Burnt orange | 1 | 4 cm | |
| 17 | RAAOC | Scarlet | 2 | 2 cm | 3 mm |

| Serial | Corps or Group | Details of Stripe(s) – Colour | Details of Stripe(s) – Number of Stripes | Details of Stripe(s) – Width | Details of Stripe(s) – Distance Apart |
|--------|----------------|-------------------------------|--|------------------------------|---------------------------------------|
| 18 | RAEME | Scarlet | 1 | 4 cm | |
| 19 | RAAEC | University blue | 1 | 4 cm | |
| 20 | AAPRS | Bottle green | 1 | 1 cm | |
| 21 | AACC | Grey | 1 | 4 cm | |
| 22 | RAAPC | Gold | 1 | 4 cm | |
| 23 | AALC | Scarlet | 1 | 4 cm | |
| 24 | RACMP | White | 1 | 3 cm | |
| 25 | AA Psych | Maroon | 1 | 3 cm | |
| 26 | AABC | Scarlet | 1 | 1 cm | |
| 27 | RAANC | Grey | 1 | 1 cm | |
| 28 | Army CadetS | Royal blue | 4 cm | | |

16. **Mess Dress trousers and slacks width.** The Mess Dress trousers and slacks are IAW [Annex 5O](#).

17. **Length of skirt.** The bottom edge of the blue skirt is IAW [Annex 5O](#).

Shirts

18. **Mess Dress.** The shirt is to be white, with French front requiring studs. The turn down collar, double cuffs and front are to be a Marcella-type material. The body and sleeves are to be of polyester and the collar peaks are to be approximately 6 cm in length. Alternatively, a shirt as described above but with a winged collar may be worn.

19. **Mess Dress White Jacket.** The shirt is to be white, soft and plain fronted, have soft cuffs and a turn down collar. Shirt studs are not to be worn with this shirt. Shirts purchased privately are to be similar in style to the issued item.

20. **Restrictions.** Pleated or pique-fronted shirts are not to be worn with any order of Mess Dress. Shirts of approved pattern are available through the clothing supply system.

Shirt studs

21. The shirt studs worn with the dress shirt with Mess Dress are to be plain, round and gold or silver in colour. Silver studs are worn by officers of the RAAC, AA Avn and RAANC; all other officers wear gold studs. Shirt studs are not provided at public expense.

Spurs

22. Box spurs are in [Annex 5O](#).

EMBELLISHMENTS OF MESS DRESS

23. Dress Order No 6A Mess Dress is embellished, IAW [Chapter 5](#). The positioning of those items is in Figure 503–1 and Figure 503–2. The types of embellishment worn are as follows:
- a. **Army identification.** A bullion Australian Army Rising Sun Badge is worn at the top of the left sleeve 2 cm below the shoulder seam of jacket by Senior officers, COL rank and above. All other officers wear the Australian Army Rising Sun Badge, embroidered on appropriate colour background.
 - b. **‘AUSTRALIA’ shoulder titles.** ‘AUSTRALIA’ shoulder titles are worn on both epaulettes of the jacket, 5 mm from the edge of the shoulder seam of the jacket by officers up to and including LTCOL rank.
 - c. **Badges of rank or rank insignia.** Metal badges of rank are worn on shoulder straps or epaulettes by officers up to and including LTCOL rank. Senior officers of COL and above, wear bullion badges of rank.
 - d. **Buttons.** Line-30 Australian Army Rising Sun buttons are to be worn on both epaulettes of the jacket. The Australian Army Rising Sun buttons (screw-in type) are to worn.
 - e. **Collar badges.** Officers up to and including LTCOL rank, wear Corps/Regiment collar badges on the jacket lapel. The badges are positioned with the highest point of the badge 18 cm below the shoulder seam of the jacket. Collar badges are not worn by Senior officers when wearing the Staff Corps Mess Dress.
 - f. **Orders, decorations and medals.** Miniature insignia of orders, decorations and medals are worn horizontally on the left lapel, 1 cm above the collar badge. Neck decorations are worn with Mess Dress and are suspended from the miniature ribbon of the order. Where the width of the medals exceeds the width of the lapel, the inside edge of the miniature medals is to be positioned against the inner edge of the lapel. For Senior officers who do not wear collar badges, the miniature medals are positioned with the lowest edge of medals 18 cm below the shoulder seam of the jacket. Miniatures of approved unofficial awards are worn in the same position on the right lapel.
 - g. **Emblems of unit citations and awards.** Miniature emblems of Unit citations and awards are worn on the right lapel. If only 1 emblem of a Unit Citation or award is worn, it is positioned 1 cm above the collar badge. If a miniature unofficial medal is worn, the medal is positioned 1 cm above the top of the right collar badge. For Senior officers who do not wear collar badges, the bottom edge of the lowest Unit Citation or award, is to be 18 cm below the shoulder seam of the jacket.

- h. **Service/Defence commendations and Soldiers medallion badge.** Miniature Service/Defence commendations and/or Soldiers Medallion Badge are worn on the right lapel. A maximum of four commendations or Soldiers Medallion Badge is to be worn. If only one commendation is worn, it is positioned 1 cm above the collar badge. If a miniature unofficial medal is worn, the medal is positioned 1 cm above the top of the right collar badge. If only one emblem of a Unit Citation or award and Service/Defence commendation and/or Soldiers Medallion Badge is worn, the commendation or Soldiers Medallion Badge is positioned 1 cm above the Unit Citation or award. For Senior officers who do not wear collar badges, the bottom edge of the lowest Unit Citation or award, is to be 18 cm below the shoulder seam of the jacket.
- i. **Infantry Combat Badge and Army Combat Badge.** Entitled members are to wear the miniature ICB or ACB centrally on the left lapel, 1 cm above the top of miniature medals. If an aircrew badge is worn, the ICB or ACB is positioned 1 cm above that badge, centrally on the lapel. Only one badge (either the ICB or ACB) is to be worn.
- j. **Aircrew and parachute instructor badges.** Miniature bullion aircrew badges or parachute instructor badge are positioned 1 cm above miniature medals or 1 cm above the left collar badge by qualified officers. If a member has more than one qualification, only one badge is to be worn.
- k. **Parachute badges.** Miniature bullion parachute badges are to be worn by eligible officers at the top of the right sleeve, 2 cm below the shoulder seam of the jacket. If a trade badge is also worn, the parachute badge is worn 1 cm below the trade badge. The full size basic parachute qualification badge is embroidered on a white background and other parachute badges are embroidered on their particular background colours.
- l. **Trade badges.** Miniature bullion trade qualification badges are to be worn by eligible officers at the top of the right sleeve, 2 cm below the shoulder seam of the jacket. The trade badge is worn 1 cm above the parachute badge if both are worn. If a member has more than one qualification, only one badge is to be worn. The badge of the members' current employment trade is to be worn. Where a member is not employed in a trade, the badge of the last employed trade is to be worn.
- m. **Military skills badges.** Miniature bullion military skills badges are to be worn by eligible officers at the top of the left sleeve, 1 cm below the Australian Army Rising Sun Badge.
24. All miniature bullion badges are to be on blue background. They are not provided at public expense.

Figure 503-1: Positioning of Embellishments on Mess Dress (Senior Officer)

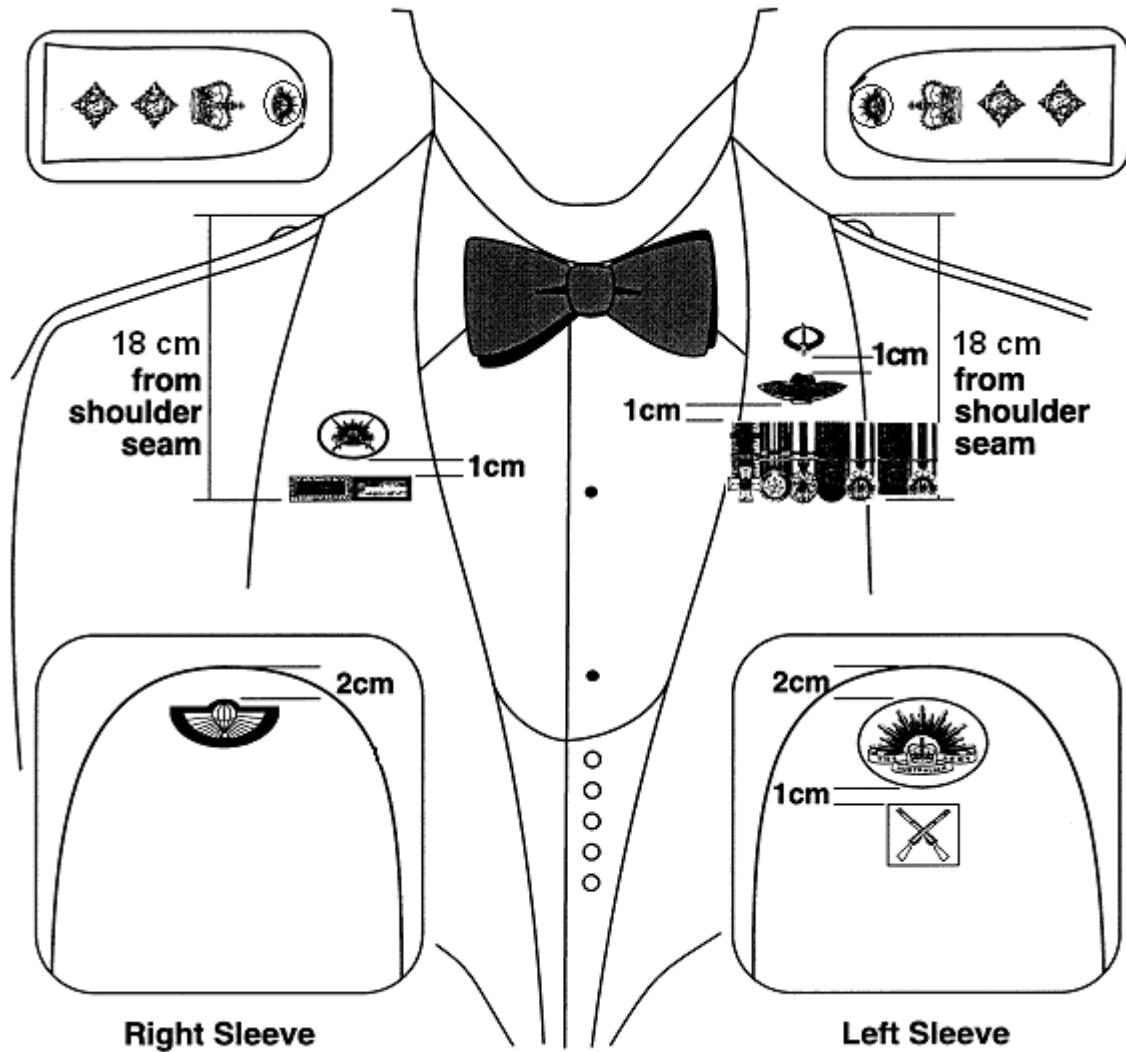

Notes:

- (a) With Mess Dress, Senior officers wear bullion rank insignia. Bullion 'AUSTRALIA' titles are not worn with the Australian Army Rising Sun Badge.
- (b) Bullion Australian Army Rising Sun Badge is worn on Mess Dress.
- (c) Miniature bullion trade, parachute, military skills and aircrew badges are optional on Mess Dress. They are not provided at public expense.

Figure 503-2: Positioning of Embellishments on Mess Dress (Officer – Lieutenant Colonel and below)

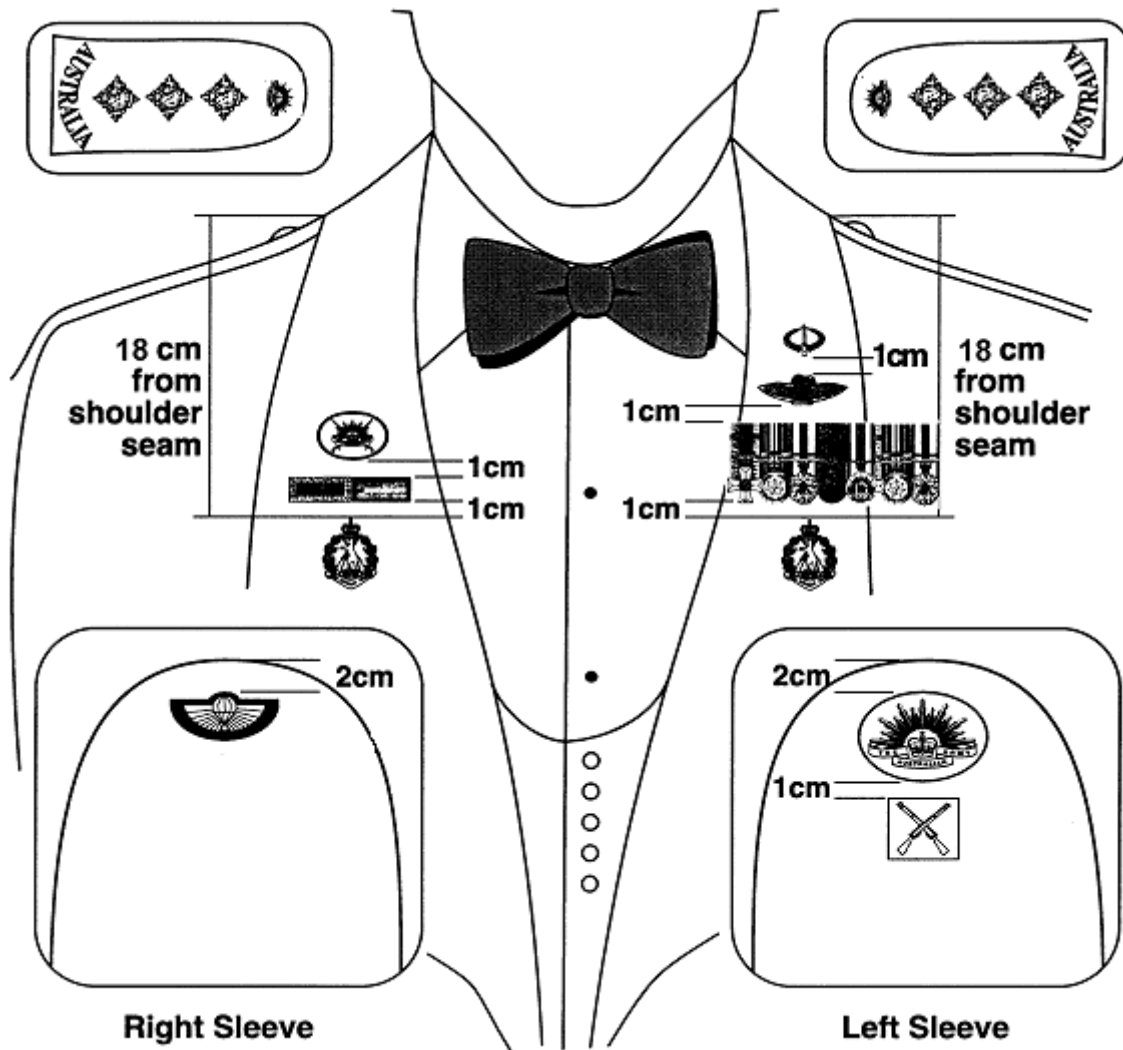

Notes:

- (a) Metal rank insignia and 'AUSTRALIA' shoulder titles are to be worn.
- (b) Miniature bullion trade, parachute, military skills and aircrew badges are optional on Mess Dress. They are not provided at public expense.
- (c) Embroidered Australian Army Rising Sun Badge on appropriate colour background is to be worn.

EMBELLISHMENTS OF MESS DRESS WHITE JACKET

25. Dress Order No 6B Mess Dress White Jacket is embellished, IAW [Chapter 5](#). The positioning of those items is in Figure 5O3–3 and Figure 5O3–4. The types of embellishment worn are as follows:

- a. **Army identification.** An embroidered Australian Army Rising Sun Badge on white background is worn on the top of the left sleeve, 2 cm below the shoulder seam of jacket.
- b. **‘AUSTRALIA’ shoulder titles.** ‘AUSTRALIA’ shoulder titles are to be worn on both epaulettes of the jacket, 5 mm from the edge of the shoulder seam of the jacket.
- c. **Badges of rank or rank insignia.** Metal rank insignia is worn by officers and embroidered badges of rank on white background are worn by WOs and SNCOs on the sleeves. WO rank insignia is positioned 13.5 cm from the top of the badge to the shoulder seam of the jacket. SNCO rank insignia is positioned 15.5 cm from the top of the chevron to the shoulder seam of the jacket.
- d. **Buttons.** Line-30 Australian Army Rising Sun buttons are to be worn on both epaulettes of the jacket. The Australian Army Rising Sun buttons (screw-in type) are to worn.
- e. **Collar badges.** Collar badges appropriate to Corps/Regiment or appointment, are worn on the lapels of the white jacket. Officers up to and including LTCOL rank, wear Corps/Regiment collar badges on the jacket lapel. The badges are positioned with the highest point of the badge 18 cm below the shoulder seam of the jacket. Collar badges are not worn by Senior officers.
- f. **Orders, decorations and medals.** Miniature insignia of orders, decorations and medals are worn horizontally on the left lapel, 1 cm above the collar badge. Neck decorations are worn with Mess Dress and are suspended from the miniature ribbon of the order. Where the width of the medals exceeds the width of the lapel, the inside edge of the miniature medals is to be positioned against the inner edge of the lapel. For Senior officers who do not wear collar badges, the miniature medals are positioned with the lowest edge of medals 18 cm below the shoulder seam of the jacket. Miniatures of approved unofficial awards are worn in the same position on the right lapel.
- g. **Emblems of unit citations and awards.** Miniature emblems of Unit citations and awards are worn on the right lapel. If only one emblem of a Unit Citation or award is worn, it is positioned 1 cm above the collar badge. If a miniature unofficial medal is worn, the medal is positioned 1 cm above the top of the right collar badge. For Senior officers who do not wear collar badges, the bottom edge of the lowest Unit Citation or award, is to be 18 cm below the shoulder seam of the jacket.
- h. **Service/Defence commendations and Soldiers medallion badge.** Miniature Service/Defence commendations and/or Soldiers Medallion Badge

are worn on the right lapel. A maximum of four commendations or Soldiers Medallion Badge is to be worn. If only one commendation is worn, it is positioned 1 cm above the collar badge. If a miniature unofficial medal is worn, the medal is positioned 1 cm above the top of the right collar badge. If only one emblem of a Unit Citation or award and Service/Defence commendation and/or Soldiers Medallion Badge is worn, the commendation or Soldiers Medallion Badge is positioned 1 cm above the Unit Citation or award. For Senior officers who do not wear collar badges, the bottom edge of the lowest Unit Citation or award, is to be 18 cm below the shoulder seam of the jacket.

- i. **Infantry Combat Badge and Army Combat Badge.** Entitled members are to wear the miniature ICB or ACB centrally on the left lapel, 1 cm above the top of miniature medals. If an aircrew badge is worn, the ICB or ACB is positioned 1 cm above that badge, centrally on the lapel. Only one badge (either the ICB or ACB) is to be worn.
- j. **Aircrew and parachute instructor badges.** Miniature bullion aircrew badges or parachute instructor badge are to be worn on the left lapel by qualified officers. Miniature embroidered badges are worn by eligible WOs and SNCOs in the same manner as officers. Where a member has more than one qualification only one badge is to be worn. Miniature bullion aircrew badges or parachute instructor badge are positioned 1 cm above miniature medals or 1 cm above the left collar badge by qualified officers. If a member has more than one qualification, only one badge is to be worn.
- k. **Parachute badges.** Miniature bullion parachute badges are to be worn by eligible officers on the top of the right sleeve. If a trade badge is also worn, the parachute badge is worn 1 cm below the trade badge. Full size embroidered parachute badges on white or base colour background, are worn by eligible WOs and SNCOs on the right sleeve, 7.5 cm below the shoulder seam of the jacket.
- l. **Trade badges.** Miniature bullion trade qualification badges are to be worn by eligible officers on the top of the right sleeve. The trade badge is worn 1 cm above the parachute badge if both are worn. If a member has more than one qualification, only one badge is to be worn. The badge of the members' current employment trade is worn. Where a member is not employed in a trade, the badge of the last employed trade is to be worn. Full size embroidered trade qualification badges on white or base colour background are worn by eligible WOs and SNCOs on the top of the right sleeve, 2 cm below the shoulder seam of the jacket.
- m. **Military skills badges.** Full size military skills badges on white background are worn by eligible personnel on the left sleeve, 1 cm below the Australian Army Rising Sun Badge.

POSITIONING OF EMBELLISHMENTS

26. Unlike embellishments worn on sleeves, embellishments worn on the lapels do not have defined positions. Embellishments are placed 1 cm above the embellishment below. The position of embellishments is determined from the collar badge or, if collar badges are not worn, the bottom of the lowest embellishment is located 18 cm below the shoulder seam. The first embellishment is worn 1 cm above the collar badge.

Figure 503-3: Positioning of Embellishments on Mess Dress White Jacket (Commissioned Officers)

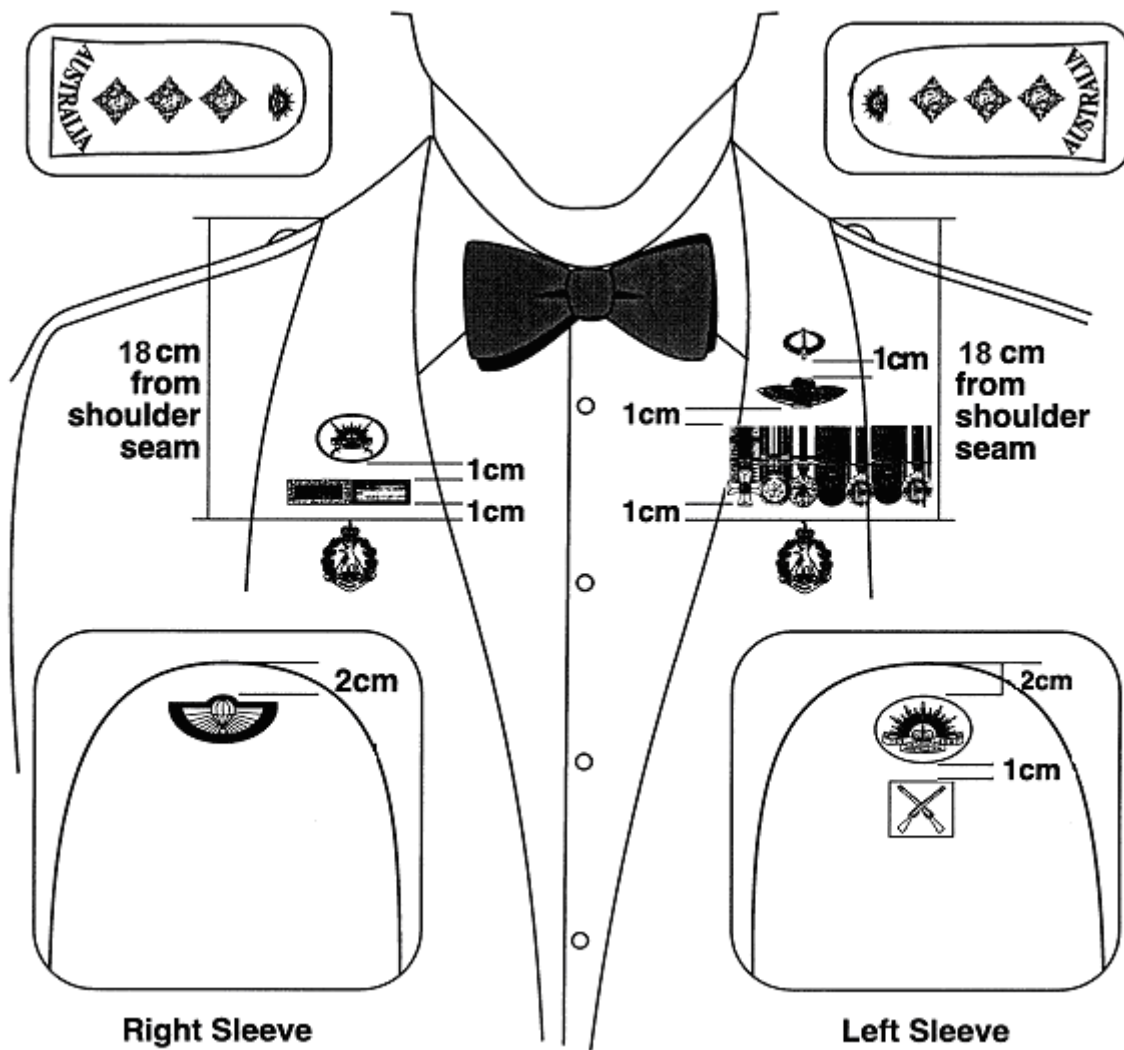

Notes:

- (a) Metal rank insignia and 'AUSTRALIA' shoulder titles are worn by all officers.
- (b) Embroidered Australian Army Rising Sun Badge on appropriate colour background.
- (c) Miniature embroidered bullion aircrew or parachute instructor badge is to be worn by qualified members.
- (d) Full size embroidered parachute wings are to be worn.

Figure 503-4: Positioning of Embellishments on Mess Dress White Jacket (Warrant Officers and Senior Non-Commissioned Officers)

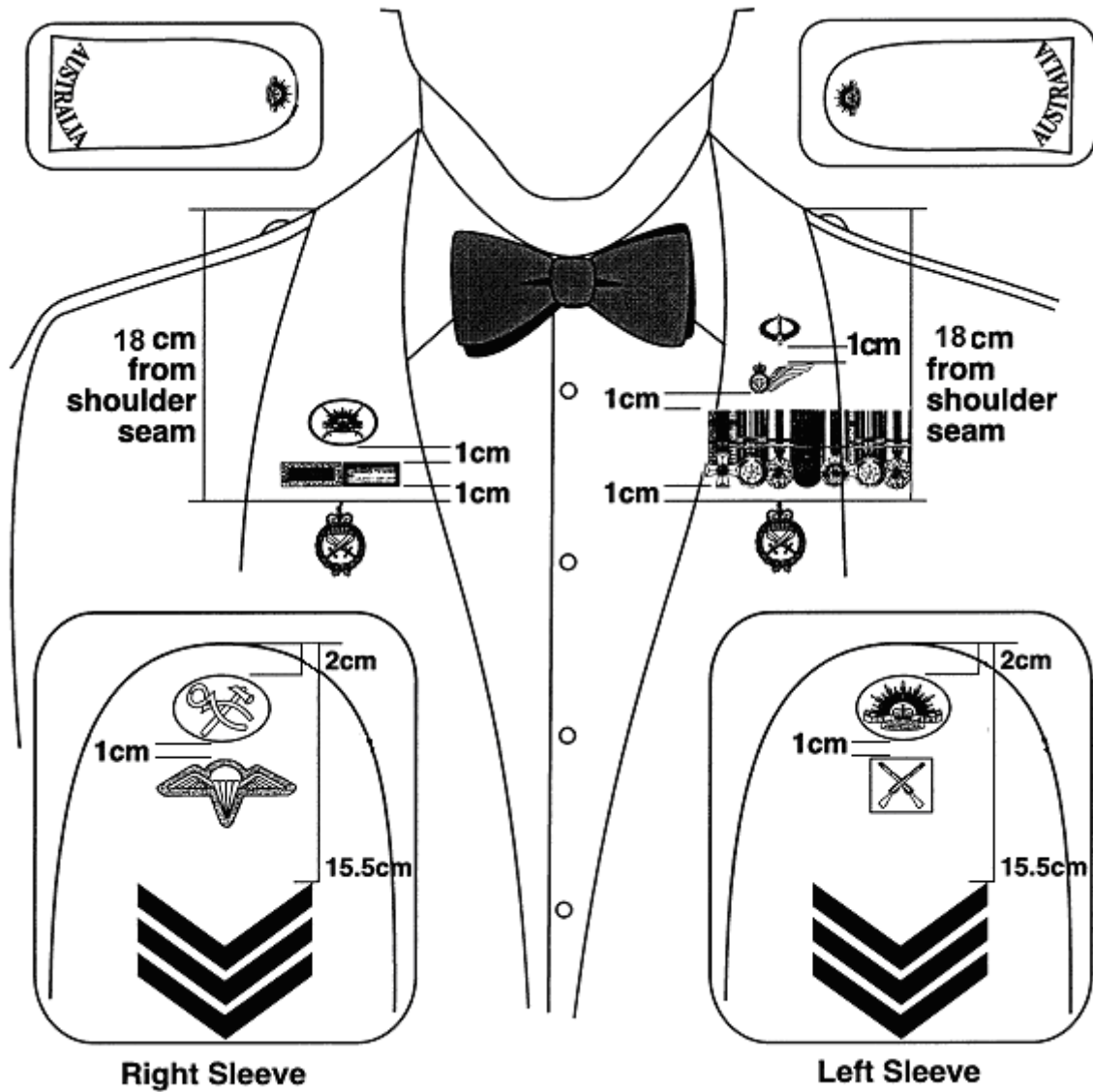

Notes:

- (a) WO rank insignia is to be positioned 13.5 cm from the shoulder seam of the jacket.
- (b) Miniature embroidered bullion aircrew or parachute instructor badge is to be worn by qualified members.
- (c) Full size embroidered parachute wings are to be worn.

TRI-SERVICE EQUIVALENCIES ORDERS OF DRESS

DRESS EMBELLISHMENTS

The Tri-Service equivalencies orders of dress are in Table 5P-1^{Notes (a) and (b)}.

Table 5P-1: Tri-Service equivalencies Orders of Dress

| Serial (a) | Service (b) | Dress Order Number (c) | Dress (d) | Remarks (e) |
|---------------|----------------|---------------------------------|---|---|
| 1 | Army | 1A | Ceremonial Parade Service Dress | Worn by personnel on parade |
| | RAN | W1 | Winter Ceremonial Uniform | Worn by personnel on parade with sword and medals |
| | RAAF | 4A | Ceremonial Dress Air Force Blue Tunic | Worn by personnel on parade |
| 2 | Army | 1B | Ceremonial Service Dress | Worn by guests to a parade |
| | RAN | W2 | Winter Ceremonial Uniform | Worn by guests to a parade with medals |
| | RAAF | 4A | Ceremonial Dress Air Force Blue Tunic | Worn by guests to a parade |
| 3 | Army | 1C | General Duty Service Dress | With ribbons |
| | RAN | W7 | Winter Non-Ceremonial Day Dress | With ribbons |
| | RAAF | 1A | Service Dress Air Force Blue Tunic | With ribbons |
| 4 | Army | 2A | Ceremonial Parade Dress | Worn by personnel on parade |
| | RAN | S1 | Summer Ceremonial Uniform | Worn by personnel on parade with sword and medals |
| | RAN | W1 | Winter Ceremonial Uniform | Worn by personnel on parade with sword and medals |
| | RAAF | 4B | Ceremonial Dress Long Sleeve Shirt and Tie | Worn by personnel on parade |
| | RAAF | 4C | Ceremonial Dress Short Sleeve Shirt | Worn by personnel on parade |

| Serial (a) | Service (b) | Dress Order Number (c) | Dress (d) | Remarks (e) |
|-------------------|--------------------|-------------------------------|---|---|
| 5 | Army | 2B | Ceremonial Parade Dress Cold Weather | Worn by personnel on parade |
| | RAN | W1 | Winter Ceremonial Uniform | Worn by personnel on parade with sword and medals |
| | RAN | W2 | Winter Ceremonial Uniform | Worn by personnel on parade with sword and medals |
| | RAAF | 4A | Ceremonial Dress Air Force Blue Tunic | Worn by personnel on parade |
| 6 | Army | 2C | Ceremonial Dress | Worn by guests to a parade |
| | RAN | S1 | Summer Ceremonial Uniform | Worn by guests to a parade with medals |
| | RAN | W1 | Winter Ceremonial Uniform | Worn by guests to a parade with medals |
| | RAN | S2 | Summer Ceremonial Uniform | Worn by guests to a parade with medals |
| | RAAF | 4B | Ceremonial Dress Long Sleeve Shirt and Tie | Worn by guests to a parade |
| | RAAF | 4C | Ceremonial Dress Short Sleeve Shirt | Worn by guests to a parade |
| 7 | Army | 2D | Ceremonial Dress Cold Weather | Worn by guests to a parade |
| | RAN | W1 | Winter Ceremonial Uniform | Worn by guests to a parade with medals |
| | RAN | W2 | Winter Ceremonial Uniform | Worn by guests to a parade with medals |
| | RAAF | 4A | Ceremonial Dress Air Force Blue Tunic | Worn by guests to a parade |
| | RAAF | 4B | Ceremonial Dress Long Sleeve Shirt and Tie | Worn by guests to a parade |
| 8 | Army | 2E | General Duty Dress (polyesters) | With ribbons |
| | RAN | S7 | Summer Non-Ceremonial Day Dress | With ribbons |
| | RAN | S8 | Summer Non-Ceremonial Day Dress | With ribbons |
| | RAN | S9 | Summer Working Dress | With ribbons |
| | RAAF | 1C | Service Dress Short Sleeve Shirt | With ribbons |

| Serial (a) | Service (b) | Dress Order Number (c) | Dress (d) | Remarks (e) |
|---------------|----------------|---------------------------------|--|--|
| | RAAF | 6D | Tropical Dress | With ribbons |
| 9 | Army | 2F | General Duty Dress Cold Weather | With ribbons |
| | RAN | S7 | Summer Non-Ceremonial Day Dress | With ribbons |
| | RAN | W7 | Winter Non-Ceremonial Day Dress | With ribbons |
| | RAAF | 1B | Service Dress Long Sleeve Shirt and Tie | With ribbons |
| | RAAF | 1C | Service Dress Short Sleeve Shirt | With ribbons |
| 10 | Army | 3A | Ceremonial Safari Suit | Worn by guests to a parade with medals or general duty with ribbons |
| | RAN | S1 | Summer Ceremonial Uniform | Worn by guests to a parade with medals or general duty with ribbons |
| | RAN | S7 | Summer Non-Ceremonial Dress | Worn by guests to a parade with medals or general duty with ribbons |
| | RAAF | 4C | Ceremonial Dress Short Sleeve Shirt | Worn by guests to a parade with medals or general duty with ribbons |
| | RAAF | 6D1 | Safari Suit | Worn by guests to a parade with medals or general duty with ribbons |
| 11 | Army | 4A | General Duty Dress (DPCU) | |
| | RAN | S7 | Summer Non-Ceremonial Dress | |
| | RAN | S9 | Summer Working Dress | |
| | RAN | W7 | Winter Non-Ceremonial Day Dress | With ribbons |
| | RAN | W9 | Winter Working Dress | |
| | RAAF | DPCU | Working Dress | |
| 12 | Army | 4B | Field Dress (DPCU) | |
| | RAN | S18 | Combat Ensemble | |
| | RAN | W9 | Winter Working Dress | |
| | RAN | W18 | Combat Ensemble (DPCU/DPNU) | |

| Serial (a) | Service (b) | Dress Order Number (c) | Dress (d) | Remarks (e) |
|---------------|----------------|---------------------------------|--|--------------------|
| | RAAF | DPCU | Field Dress (DPCU) | |
| 13 | Army | 6A | Mess Dress | With miniatures |
| | RAN | W4 | Winter Mess Dress | With miniatures |
| | RAAF | 5B | Mess Dress Winter | With miniatures |
| 14 | Army | 6B | Mess Dress White Jacket | With miniatures |
| | RAN | S4 | Summer Mess Dress | With miniatures |
| | RAN | S5 | Summer Mess Undress | With miniatures |
| | RAAF | 5A | Mess Dress Summer | With miniatures |
| 15 | Army | 6C | Senior Ranks Mess Dress | With miniatures |
| | RAN | W4 | Winter Mess Dress | With miniatures |
| | RAAF | 5B | Mess Dress Winter | With miniatures |
| 16 | Army | 6D | Mess Dress Army | With miniatures |
| | RAN | S4 | Summer Mess Dress | With miniatures |
| | RAN | S5 | Summer Mess Undress | With miniatures |
| | RAN | S6 | Informal Evening Dress | With miniatures |
| | RAN | W4 | Winter Mess Dress | With miniatures |
| | RAAF | 5A | Mess Dress Summer | With miniatures |
| | RAAF | 5B | Mess Dress Winter | With miniatures |
| | RAAF | 5D | Mess Dress Tropical | With miniatures |
| 17 | Army | SO1 | Patrol Blue White Jacket Senior Officer | |
| | RAN | S2 | Summer Ceremonial Uniform | |
| | RAN | W2 | Winter Ceremonial Uniform | |
| | RAAF | 2B | Ceremonial Dress Air Vice-Marshal and above | Guest or spectator |
| | RAAF | 3 | Attaché Dress ADFA Ceremonial Jacket | |

| Serial (a) | Service (b) | Dress Order Number (c) | Dress (d) | Remarks (e) |
|-----------------------|------------------------|---|---|------------------------|
| 18 | Army | SO2 | Ceremonial Service Dress General Officer | |
| | RAN | S1 | Summer Ceremonial Uniform | |
| | RAN | W1 | Winter Ceremonial Uniform | |
| | RAAF | 2A | Ceremonial Dress Air Vice-Marshal and above | |

Notes:

- (a) RAN and RAAF single Service Dress Manuals (E) should be followed, in order to determine the occasions of dress and orders of dress to be worn during such occasions.
- (b) The Hat KFF is to be worn by all Army personnel in lieu of the beret when such members are a part of a tri-Service contingent (whether in Australia or overseas), and when such members participate in or attend as a spectator at a ceremonial parade or activity.

CHAPTER 6

INTERPRETATION OF THE ARMY DRESS MANUAL

The Army Dress Manual is to be interpreted as positive instructions, meaning if a situation is **not** specified in the Army Dress Manual, it is therefore **prohibited**; however, elements of this manual provide specific direction to the reader.

ORDERS, DECORATIONS AND MEDALS

INTRODUCTION

6.1 Classes of orders, decorations and medals are awarded to individuals for gallantry, meritorious service or achievement, operational service, certain non-operational service and long or special service. The policy and procedures for the current system of Australian honours and awards is in the Defence Honours and Awards Manual, Volume 1.

HISTORY

6.2 Medals for bravery or participation in campaigns can be traced back to the ancient Egyptians and Romans, where plaques of brass or copper were awarded for outstanding feats of bravery. The first British medals to be issued and classed as such, did not appear until 1588, when they were struck by Queen Elizabeth I, upon the defeat of the Spanish Armada. They were made from gold and silver and were fitted with rings and chains for suspension around the neck.

6.3 In 1643, King Charles I awarded a medal for conspicuous conduct to Robert Welch for recovering the Royal Standard during the first battle of the English Civil War, at the Battle of Edgehill. This was the first British Monarch to award a military medal for prowess on the battlefield. In 1650, Oliver Cromwell awarded the first campaign medals to both officers and men; the medal was known as the Dunbar Medal and commemorated the defeat of the Scots Royalists at Dunbar. This medal was also suspended from the neck.

6.4 The first official war medal of the type we know today was the 1815 Waterloo Medal and was awarded with a ribbon and an instruction stating ‘... the ribbon issued with the medal shall never be worn but with the medal suspended on it’. From this time on, medals were struck for nearly every engagement and later medals were introduced as honours and awards.

6.5 Today there is some confusion about the difference between honours and awards, and orders, decorations and medals. An ‘honour’ is an appointment made to an order whilst ‘awards’ cover decorations and medals.

6.6 In 1975, Australia moved from the British Imperial system of honours and awards with the introduction of the Order of Australia. Australia also produced its own service medal for World War Two, the Australia Service Medal (1939–45) and together with New Zealand struck the Vietnam Medal in 1964.

6.7 The Australian system of honours and awards now comprises a wide range of decorations and medals, in addition to the Order of Australia. The history and description of Australian, Imperial and foreign systems of honours and awards is in the Defence Honours and Awards Manual, Volume 2.

GENERAL

6.8 This chapter details those aspects of orders, decorations and medals under the Australian system of honours and awards, which pertain to specific orders of dress, in accordance with (IAW) [annex 6A](#) and the Defence Honours and Awards Manual. It also refers to awards made under the Imperial system, the UN, NATO and other organisations and foreign nations.

6.9 Emblems of unit and group citations or awards, Service/Defence commendations and Soldiers Medallion Badge are in [annex 4L](#), [annex 4N](#) and [annex 4P](#) and the Defence Honours and Awards Manual, respectively.

DEFINITIONS

6.10 Definitions are applied to all aspects relating to honours and awards within the Army Dress Manual:

- a. **Honours and awards.** Collective terms for orders, decorations, medals, commendations and citations awarded to individuals, groups or units.
- b. **Official awards.** An official award is one which is instituted by The Sovereign under Letters Patent, to accord recognition to individuals or groups of people.
- c. **Order of wearing.** Official awards are worn, IAW [annex 6C](#) and the Defence Honours and Awards Manual, and are worn above the left breast, with the exception of neck badges. This list is produced by Government House and shows official awards in order of seniority.
- d. **Orders.** An order is a group of awards in varying degrees of precedence under a single title. The Order of Australia, an order of chivalry, is the only order within the Australian system of honours and awards and was established by Letters Patent on 14 February 1975, by Her Majesty, Queen Elizabeth II. The Order of Australia comprises five classes with post-nominal letters as follows:

| | | |
|-----|---------------------------------------|------------------------------|
| (1) | Knight/Dame of the Order of Australia | AK/AD (not currently active) |
| (2) | Companion of the Order of Australia | AC |
| (3) | Officer of the Order of Australia | AO |
| (4) | Member of the Order of Australia | AM |
| (5) | Medal of the Order of Australia | OAM |

- e. **Decorations.** A decoration is an award, normally in the form of a cross or a star made for valour, gallantry, bravery, distinguished service or conspicuous service. Australian decorations with post-nominal letters are as follows:

- | | | |
|-----|------------------------------|----------------------------|
| (1) | Victoria Cross for Australia | VC |
| (2) | Cross of Valour | CV |
| (3) | Star of Gallantry | SG |
| (4) | Star of Courage | SC |
| (5) | Distinguished Service Cross | DSC |
| (6) | Conspicuous Service Cross | CSC |
| (7) | Nursing Service Cross | NSC (not currently active) |

f. Decorations may have an associated medal which is lower in the order of wearing. Associated medals within the Australian system of honours and awards are as follows:

- | | | |
|-----|-----------------------------|-----|
| (1) | Medal for Gallantry | MG |
| (2) | Bravery Medal | BM |
| (3) | Distinguished Service Medal | DSM |
| (4) | Conspicuous Service Medal | CSM |

g. At times, dress instructions on invitations use the term 'decorations' to refer to all honours and awards.

h. **Medals.** The term 'medals' includes badges of lower classes of orders (worn as medals rather than neck badges or breast stars), and medals associated with decorations, for example the Member of the Order of Australia and Medal of the Order of Australia. Medals may be divided into the following groups:

- (1) medals for gallantry in action or for bravery in peacetime
- (2) medals for meritorious service and special service or achievement in peacetime
- (3) medals for war service and non-warlike service
- (4) medals for long service
- (5) Coronation, Jubilee or other commemorative medals.

i. **Post-nominals.** Post-nominal letters are letters placed after the name of an individual to indicate the award of a duly appointed honour or decoration. Several awards within the Australian system allow for the use of post-nominal letters comprising the initials of an award. The following is an example of this:

- | | | |
|-----|------------------------------|----|
| (1) | Victoria Cross for Australia | VC |
|-----|------------------------------|----|

- j. **Riband.** The term 'riband' is used to denote the silk ribbon from which an order, decoration or medal is suspended or the ribbon-like device, which may be incorporated in the actual badge of an order.
- k. **Bars.** A bar is a full width metal device worn on the riband of a decoration or medal awarded for valour, gallantry, bravery, distinguished or conspicuous service to signify an additional award of a decoration or medal.
- l. **Clasps.** A clasp, similar in appearance to, but not to be confused with a bar, is a full width metal device, worn on the riband of medals which specifies one of the following:
- (1) the geographical area of a campaign
 - (2) an additional period of qualifying service for long service awards
 - (3) the date of an award, for example, the Champion Shots Medal.
- m. **Ribbon/ribbon bar.** The term 'ribbon' applies to the silk ribbon of an order, decoration or medal when the material is mounted to form a ribbon bar either on a brooch affixed to, or sewn on, uniforms.
- n. **Ribbon bar emblem.** The term 'emblem' denotes surcharges affixed to the ribbons of ribbon bars. These include miniature crosses placed on the ribbons of the Victoria Cross for Australia and Cross of Valour, rosettes placed on the ribbons of long service medals to signify additional periods of qualifying service, and emblems placed on the ribbons of Commendations for Gallantry, Distinguished Service and Brave Conduct.
- o. **Emblems of unit/group citations or awards.** Emblems of unit or group citations are worn, IAW [annex 4P](#) and the Defence Honours and Awards Manual.
- p. **Unofficial awards.** Unofficial awards are awards issued by private organisations or associations. These awards, which include medals for overseas service national service and frontline service, are not to be worn on the uniform. In exceptional circumstances, approval to wear medals awarded by civilian societies for bravery in saving life may be granted by the DGAPC.
- q. **Warrant.** A warrant is presented with many Australian awards. This warrant includes the citation for the award.

PROMOTION WITHIN AN ORDER

6.11 An individual appointed to a higher class within an order, for example from Member of the Order of Australia (AM) to Officer of the Order of Australia (AO), only wears the insignia of the higher class. Regulations of an order normally require the insignia of the lower class to be returned. A person appointed to a division within an order, who already holds an award in another division in the order, for example AM (Military Division) and AO (General Division) can wear both insignia in the correct order of wearing.

BARS TO AWARDS

6.12 A bar, or subsequent bars may be awarded to the holder of the following Australian awards:

- a. VC, CV, SG, SC, DSC, CSC, NSC, MG, BM, DSM and CSM.

6.13 The original award of the VC, CV, SC and BM includes a miniature replica of the crosses and medal for wearing on the ribbon bar. Additional emblems are worn on the ribbon bar to denote subsequent awards.

AWARDS FOR WHICH A MEDAL IS NOT AWARDED

6.14 The awards listed below are represented by insignia which is issued in two sizes—the full size insignia worn on a riband of appropriate colour with medals, and miniature insignia worn on a riband of appropriate colour with miniature medals. These awards are:

- a. Commendation for Gallantry
- b. Commendation for Brave Conduct
- c. Commendation for Distinguished Service.

6.15 Subsequent awards are recognised by a warrant describing the subsequent action. Insignia for subsequent awards are positioned on the riband IAW para 27 of [annex 6E](#). Subsequent awards are positioned on ribbon bars IAW Figure 6E-6.

UNOFFICIAL AWARDS

6.16 The following unofficial awards may be worn on the Australian Army uniform, subject to DGAPC approval:

- a. Royal Humane Society Medals
- b. Royal Humane Society of Australasia
- c. Royal Humane Society of New South Wales
- d. Royal National Lifeboat Institution
- e. Order of St John of Jerusalem Life Saving Medal
- f. Florence Nightingale Medal.

6.17 Approved awards are to be worn on the right breast.

6.18 No other unofficial medals and awards are authorised to be worn on the Australian Army uniform, or with civilian attire, at any time, whilst representing the ADF, unless unrestricted approval has been granted to wear foreign awards, IAW [annex 6D](#) and the Defence Honours and Awards Manual.

FOREIGN AWARDS

6.19 The policies for accepting and wearing of foreign awards are in [annex 6D](#) and the Defence Honours and Awards Manual.

AWARD SPECIFICATIONS, REGULATIONS AND ASSEMBLY INSTRUCTIONS

6.20 Award specifications, regulations and assembly instructions are detailed in [annex 6E](#).

ORDER OF WEARING

6.21 The order of wearing honours and awards is determined by the Governor-General of the Commonwealth of Australia. Honours and awards are worn IAW [annex 6C](#) and the Defence Honours and Awards Manual.

Annexes:

Annexes:

- 6A [Wearing of orders, decorations and medals](#)
- 6B [Imperial system of honours and awards](#)
- 6C [Order of wearing - Australian system of honours and awards \(modified\)](#)
- 6D [Foreign awards](#)
- 6E [Award specifications, regulations and assembly instructions](#)

WEARING OF ORDERS, DECORATIONS AND MEDALS

GENERAL

1. This annex details the policies relating to the wearing of honours and awards within the Australian system of honours and awards, a system that is much less complex than the Imperial system it replaced.
2. Orders, decorations and medals are worn on the Australian Army uniform IAW the order of wearing in [annex 6C](#).
3. Medals are to be court mounted and assembly, mounting and measurement specifications detailed in [annex 6E](#) are to be adhered to.

WEARING OF ORDERS, DECORATIONS AND MEDALS WITH THE AUSTRALIAN ARMY UNIFORM

4. Neck badges are worn with ceremonial and mess dress orders of dress, as shown in Figure 6A–1:
 - a. **Service Dress.** The neck badge is worn with the miniature riband under the shirt collar and the top of the badge placed just below the necktie knot.
 - b. **Patrol Blue/White Jacket.** The neck badge is suspended by the miniature riband, which is worn inside the collar, so the top of the badge is positioned 20mm below the lower edge of the collar.
 - c. **Mess Dress.** The neck badge is suspended by the miniature riband so that the top of the badge is positioned 20mm below the bow tie.
 - d. **Open neck.** The badge is suspended from the miniature riband so that the riband lies under the collar and the top of the badge is positioned 20mm below the highest secured button.
5. If more than one neck badge is to be worn, they are worn in accordance with (IAW) [annex 6B](#). A total of four neck decorations may be worn.
6. With the exception of neck decorations, official orders, decorations and medals are to be worn by all military members entitled to wear them, on the left breast. Authorised unofficial medals, such as the Royal Humane Society awards are to be worn on the right breast.

Figure 6A-1: Method of wearing neck badges

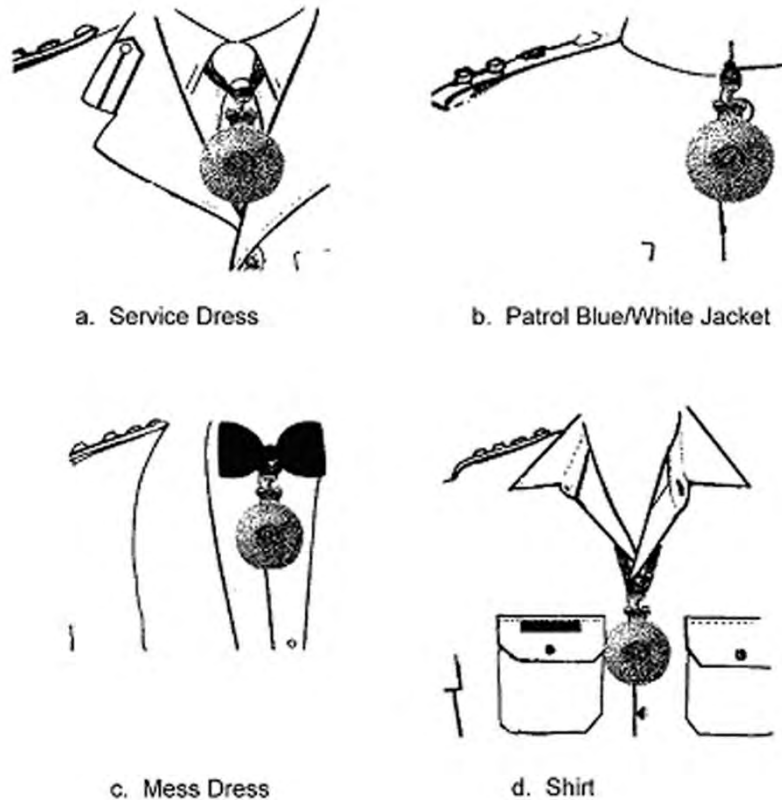

Wearing of full size medals

7. Full size medals are worn IAW the order of wearing detailed in [annex 6C](#) with the highest award worn closest to the centre of the chest.

8. Full size medals are to be court mounted either as a single medal or as a multiple medal group. They are to be mounted in a single row and positioned centrally above the left breast pocket of shirts and jackets affixed with a series of pins or brooch type bar, as shown in Figure 6A-2.

9. Full size medal specifications, regulations and assembly instructions are in [annex 6E](#).

10. The upper edge of the medal group is to be positioned 16mm above the upper edge of the pocket. This is consistent with the positioning of the upper edge of a single ribbon bar. The medal group extends over the lower edge of the pocket flap from this position to a length of 95mm.

11. Medal groups are not to extend inward beyond the button line of the coat, jacket or shirt or protrude beyond the outer edge of the garment sleeve.

12. Medals are worn displaying the obverse (which bears the principal design) to the front.
13. Medals awarded by a society for bravery in saving human life, when authorised to be worn, are worn on the right breast in a similar position as for those on the left breast.
14. Medals and other associated awards if applicable, are to be worn on Colour, Banner or Guidon belts and Drum Major sashes. They are to be positioned in the area deemed most appropriate in relation to the design of the belt/sash sitting above or below any heraldry as that design allows.

Figure 6A-2: Positioning of full size medals

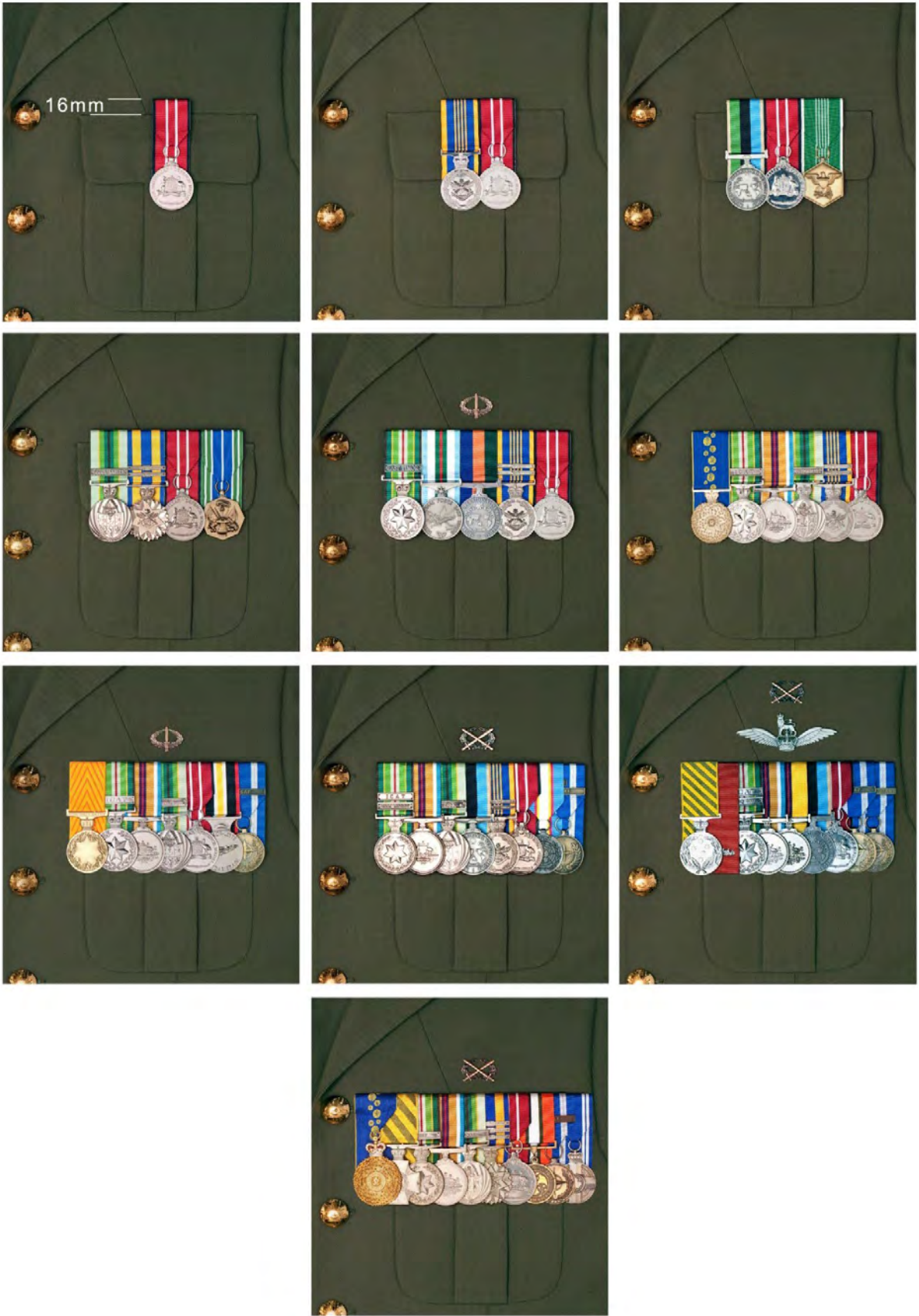

edge of the ribbon bar 3mm above the top edge of the left breast pocket as shown in Figure 6A-4 and Figure 6A-5.

25. Second and subsequent rows are to be positioned 3mm above the preceding row and are not to extend beyond the width of the lower row. Specifications for subsequent rows are detailed in [annex 6E](#).

26. Members wearing maternity uniform are to position the bottom edge of the ribbon bar 200mm below the top centre of the shoulder.

Figure 6A-4: Female ribbon bar configuration

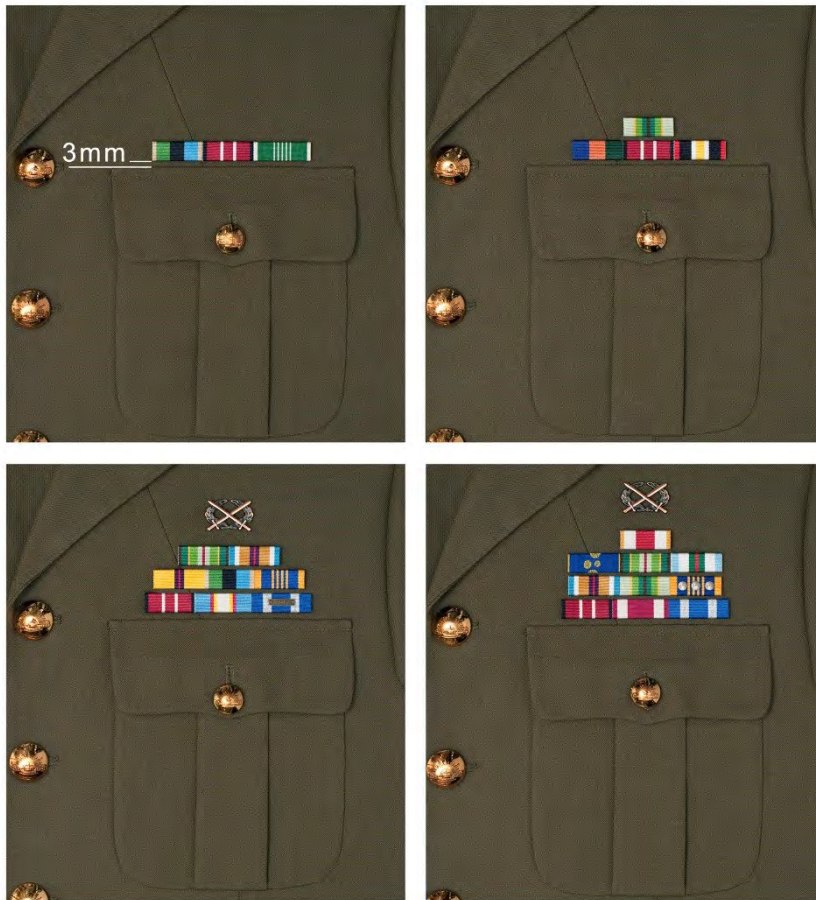
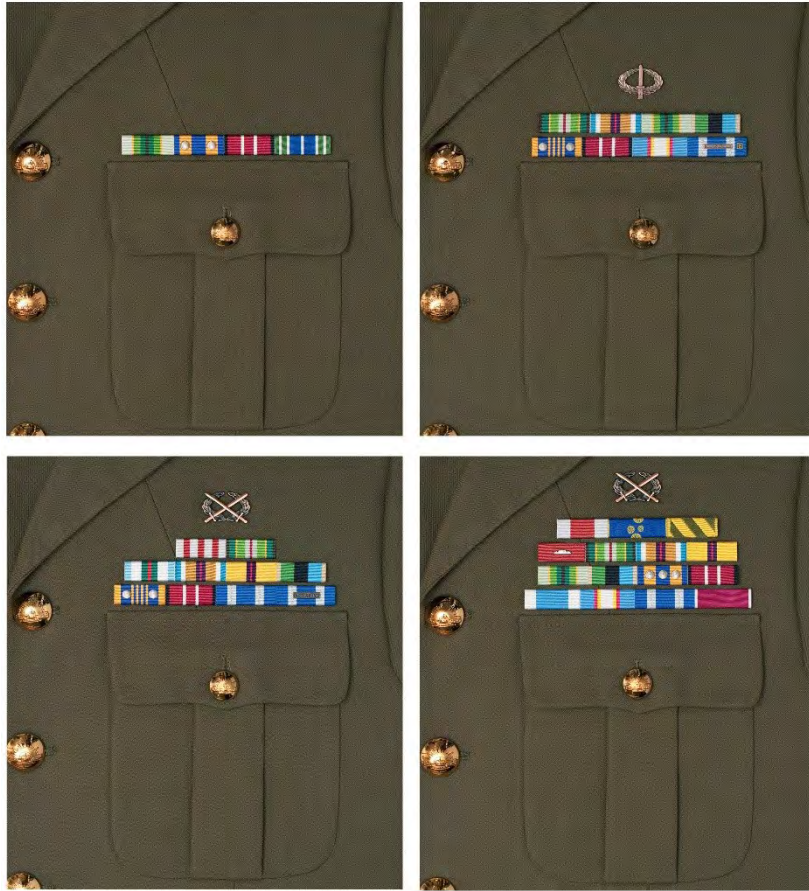

Figure 6A-5: Male ribbon bar configuration



27. Ribbon representing an **approved award** may be worn as part of a ribbon bar prior to the presentation of the award.

28. Irrespective of award approval, replica versions of awards **are not approved for wear prior to** the award being presented to the member.

29. Aircrew and parachute jump instructor badges are worn with medals and ribbons, IAW [annex 4A](#) and [annex 4G](#) respectively. The ICB/ACB is worn, IAW [annex 4B](#) and [annex 4E](#) respectively.

Positioning of emblems, insignia, rosettes, numerals, multi tour indicators and devices on ribbon bars

30. The specifications and regulations for the positioning of emblems, insignia, rosettes, numerals, multi tour indicators and devices on ribbon bars are detailed in [annex 6E](#).

Wearing emblems of unit citations, group citations and awards

31. The wearing of emblems of unit citations, group citations and awards is detailed in [annex 4P](#).

Wearing of unofficial awards

32. Ribbons of authorised unofficial awards are worn on the right breast as detailed in [annex 4P](#).

Order of St John of Jerusalem—Silver Cross

33. When the ribbon of the Order of St John of Jerusalem is worn, either in Australian Army uniform or civilian clothes, a small silver Maltese Cross is worn on the ribbon.

Wearing of orders, decorations and medals of family members

34. When in civilian clothing, a member in the immediate family of a deceased recipient of a decoration or medal, may wear the insignia awarded to that member on occasions specifically designated for military commemoration. These awards are to be worn on the right breast, directly under any citations and commendations the wearer may have been awarded. **Family members awards are not permitted to be worn on the Australian Army uniform under any circumstances.**

WEARING OF ORDERS, DECORATIONS AND MEDALS WITH CIVILIAN CLOTHES

35. The word ‘Decorations’ on an invitation card is the intimation from the host that the entertainment is official and that decorations should be worn.

Wearing decorations with Evening Dress and Dinner Jacket

36. When it is desired that decorations are to be worn with Evening Dress or Dinner Jacket, invitations will state either ‘Evening Dress—Decorations’ (for full evening dress) or ‘Dinner Jacket—Decorations’. When ‘Evening Dress—Decorations’ is prescribed those not in possession of full Evening Dress may wear Dinner Jacket, with decorations. With ‘Dinner Jacket—Decorations’, it is permissible to wear either a stiff evening collar or a soft collar.

37. The occasions on which the insignia of orders, miniatures of orders, decorations and medals are worn with Evening Dress or Dinner Jacket are:

- a. At parties and dinners when any member of the Royal Family is present. Guests may expect to be informed if any such member will be present.
- b. At functions given in embassies or residences of ambassadors and ministers, unless otherwise notified by the ambassador or minister concerned (a decoration of the country concerned should be worn in preference to a British one, and if both are worn, the former should take precedence over the latter).
- c. At evening parties given by or in the presence of a representative of the Sovereign, when within their sphere of jurisdiction.
- d. At official dinners and receptions, including Service dinners, and public dinners where the host intimates that ‘Decorations’ are to be worn.
- e. On official occasions when the hosts are:

- (1) Cabinet Ministers
 - (2) Ex-Cabinet Ministers
 - (3) Knights of the Order of the Garter
 - (4) Knights of the Order of the Thistle
 - (5) Knights of the Order of St Patrick
 - (6) Great Officers of State and of the Sovereign's Household
 - (7) Lord Mayors and Mayors.
38. With 'Evening Dress—Decorations' the following are to be worn:
- a. broad riband
 - b. up to four stars
 - c. not more than one neck badge (senior neck badge or the most appropriate to the occasion)
 - d. miniature medals.
39. With 'Dinner Jacket—Decorations' the following only are to be worn:
- a. not more than one star
 - b. not more than one neck badge (senior neck badge or the most appropriate to the occasion)
 - c. full size medals.
40. The method of wearing more than one breast star or more than one neck badge is in [annex 6B](#).

Wearing decorations with Morning Dress

41. Orders, decorations and medals are to be worn with Morning Dress on special official public functions, memorial services, etc. In each case, the host of the function or service should intimate whether the wearing of decorations is appropriate. With Morning Dress the following may be worn:
- a. up to four breast badges or stars
 - b. not more than one neck badge (senior neck badge or the most appropriate to the occasion)
 - c. full size medals.

Wearing decorations with Lounge Suit

42. With Lounge Suit, full size orders, decorations and medals are to be worn at appropriate daytime functions. At evening functions for which Lounge Suit is specified, the miniatures of orders, decorations and medals are to be worn. In addition, one neck badge may be worn. It is not customary to wear breast badges, or broad ribands and badges with Lounge Suit.

Female members

43. Females wearing civilian dress are to wear the orders, decorations and medals to which they are entitled, under the same conditions as for males. The manner of wearing the insignia of orders, decorations and medals is the same as for males, except that Dames of Orders do not wear neck badges, but wear the badge over the left breast instead.

44. Females receive awards in the Order of Australia as medals or neck badges that are not mounted on bows. They are to wear these decorations as medals or neck badges with the Australian Army uniform. A maintenance kit is available from Government House (Honours Secretariat) to mount awards on bows when wearing civilian dress.

Summary of the requirements for wearing insignia with civilian dress

45. The summary of the requirements for wearing insignia with civilian dress is in Table 6A–1 and Table 6A–2.

Table 6A–1: Summary of requirements for wearing insignia with civilian dress – Day Dress

| Dress | Medals | Neck Badges/Bow Note (a) | Breast Stars |
|-------------------------|--------------------|---------------------------------|---------------------|
| Lounge Suit | Full size | Yes | None |
| Day Dress—Ladies | Full size Note (b) | Yes | None |
| Morning Suit | Full size | Yes | Up to 4 stars |
| Formal Day Dress-Ladies | Full size Note (b) | Yes | Up to 4 stars |

Notes:

- (a) Ladies may wear insignia on a bow rather than as a neck badge.
- (b) Ladies may wear miniatures if the material or style of dress makes the wearing of full size medals inappropriate.

Table 6A–2: Summary of requirements for wearing insignia with civilian dress – Evening Dress

| Dress | Medals | Neck Badges/Bow Note (a) | Breast Stars |
|--------------|---------------|---------------------------------|---------------------|
| Lounge Suit | Miniature | Yes | None |

| Dress | Medals | Neck Badges/Bow Note (a) | Breast Stars |
|------------------------|---------------|---------------------------------|---------------------|
| Short Dress | Miniature | Yes | None |
| Dinner Suit Note (b) | Miniature | Yes | 1 only |
| Short/Long Dress | Miniature | Yes | 1 only |
| Evening Dress Note (c) | Miniature | Yes | Up to 4 stars |
| Long Dress | Miniature | Yes | Up to 4 stars |

Notes:

- (a) Ladies may wear insignia on a bow rather than as a neck badge.
- (b) Black tie
- (c) White tie

Positioning of decorations on civilian clothing

46. Medals and miniatures are worn on civilian clothing with the top of the riband placed in a similar position on the jacket or shirt as medals are placed on the Service Dress Jacket. Females are to wear the medals or miniatures in a similar position, depending on the style of dress. The positioning of decorations is shown in Figure 6A-6 and Figure 6A-7.

Figure 6A-6: Positioning of medals on Dinner Suit and ladies equivalent

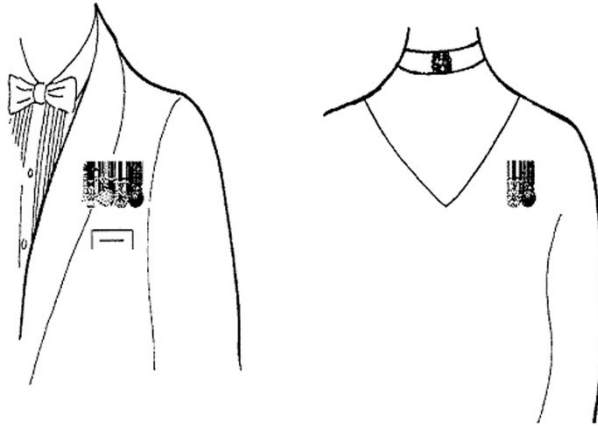
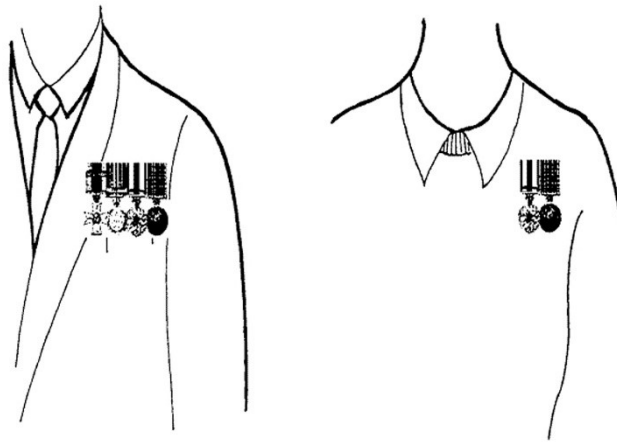

Figure 6A-7: Positioning of medals on Lounge Suit and ladies equivalent



IMPERIAL SYSTEM OF HONOURS AND AWARDS

GENERAL

1. This annex details policies relating to the wearing of honours and awards of the Imperial system, a complex system of awards that are no longer made to Australians

SENIORITY OF ORDERS

2. The order of wearing for Imperial awards is in the Defence Honours and Awards Manual Volume 1.

3. The precedence for orders in [annex 6A](#) applies to orders of similar grades. When the miniature or riband of a higher grade to a junior order is worn with a lower grade of a senior order, the higher grade miniature or riband should come first, for example the miniature or riband of a Knight/Dame Commander of the Order of the British Empire (KBE/DBE) will come before a Companion of the Order of the Bath (CB) and a Knight/Dame Grand Cross of the Order of St. Michael and St. George (GCMG) before a Knight/Dame Commander of the Order of the Bath (KCB/CDB). The riband of orders, when the riband alone is worn, will be of the width of the riband to the membership of the order. If there is no membership class, the riband will be of the width of the riband of the companionship to the order.

WEARING INSIGNIA OF ORDERS

4. The insignia of the various orders are worn as follows:

- a. First Class of an Order. Knights of the Garter, Thistle and St Patrick, and Knights and Dames Grand Cross, and Grand Commander wear a broad riband with the badge attached. They wear the collar when ordered.
- b. Second Class of an Order. Knight and Dame Commander wear a star. A neck decoration, i.e. badge suspended on a narrower riband is normally worn around the neck.
- c. Third Class of an Order. Companion and Commander wear a neck badge. The badges of Companions of the Distinguished Service Order and Imperial Service Order are worn as medals only.
- d. Fourth and Fifth Classes of an Order. Officers and Members wear the badge as for a medal.

5. Dames of Orders do not wear neck badges. They wear the badge over the left breast.

WEARING THE BROAD RIBAND

6. The broad riband of Knights of the Garter and Thistle is worn over the left shoulder and the bow from which the badge is suspended, rests on the right hip. The

broad riband of other orders is worn over the right shoulder with the bow on the left hip.

7. With Mess Dress, the broad riband is worn under the mess jacket and over the waistcoat for males. It is worn over the gown by females.
8. With ceremonial orders of dress, the broad riband passes under the shoulder strap.

WEARING COLLARS OF ORDERS

9. The collar of an order is worn instead of the broad riband on certain special occasions, as ordered, with ceremonial orders of dress only. The collar is worn under the shoulder straps hanging an equal distance front and rear, with the badge suspended below the front centre.

WEARING COMBINED ORDERS

10. The holder of more than one first class order, when wearing the collar of one order, also wears the broad riband of the next order in sequence. Only one collar is to be worn.

WEARING STARS OF ORDERS

11. Stars of orders are worn on the left side. When only one star is worn, it is to be in the centre line of the breast pocket with the upper point not less than 25mm below the lip of the pocket, or in the corresponding position on garments without a breast pocket. On certain cuts of garments, some devices may be positioned central to the pocket.

12. When two stars are worn, the second star is placed directly below the first, with its upper point not less than 25mm below the lower point of the star above.

13. When three stars are worn, the second and third stars are to be worn below the first, in horizontal line, with the second towards the wearer's right but, if in this position the stars interfere with the broad riband, the first and second stars may be worn in line with the senior star to the right, and with the third star beneath.

14. When four stars are worn, the first is worn above, the second and third in line below, with the senior star to the right, and the fourth below again, in vertical line with the first. The maximum number of stars which can be worn is four.

15. The positioning of breast stars is shown in Figure 6B-1.

Figure 6B-1: Positioning of Breast Stars, facing the wearer

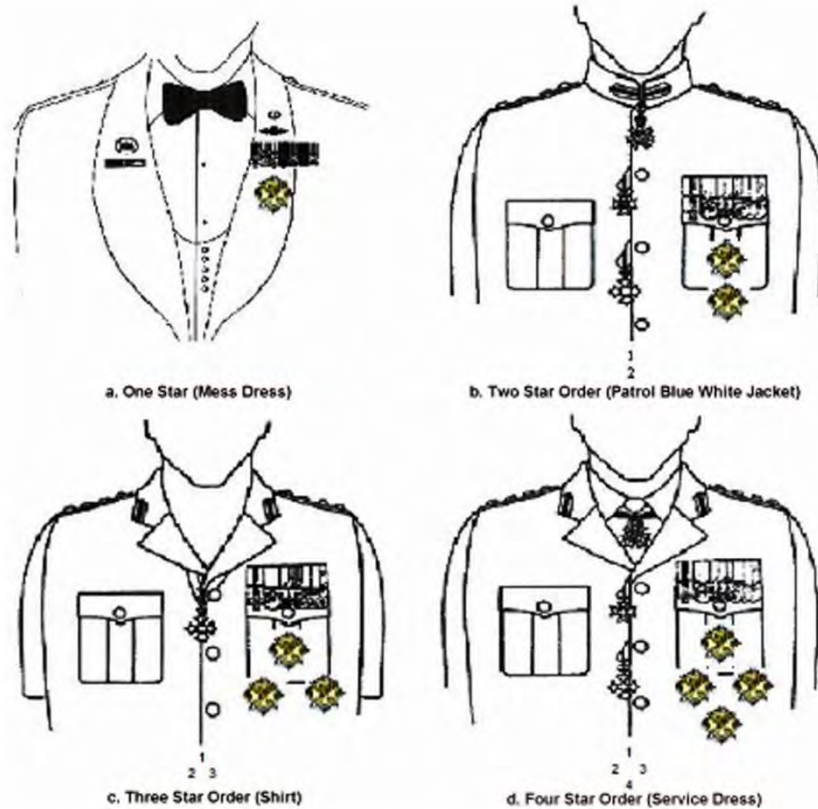

WEARING NECK BADGES

16. The maximum number of neck badges which are worn is three for ceremonial orders of dress and one with mess dress orders of dress.

17. With Service Dress, the senior or only badge is to be worn with the miniature riband under the shirt collar and the top of the badge placed just below the necktie knot. The next senior badge is suspended from the miniature riband and is to be worn with the riband emerging 20mm below the top coat button, as shown in Figure 6B-2. If a third badge is to be worn, the miniature riband is to emerge below the second button with the top of the badge 20mm below the button, as shown in Figure 6B-2.

18. With Patrol Blue Jackets, the most senior badge is suspended by the miniature riband which is worn inside the collar, so the top of the badge is positioned 20mm below the lower edge of the collar. Any other badges are worn so that the miniature riband emerges below the top and second button respectively, with the top of the badge placed 20mm below the button, as shown in Figure 6B-2.

19. With mess dress orders of dress, the badge is suspended by the miniature riband so that the top of the badge is positioned 20mm below the bow tie. Neck

badges are only worn with Mess Dress and only one neck badge is to be worn, IAW paragraph 16.

20. With open neck shirts or the Safari Suit jacket, only one neck badge is to be worn, with the badge being suspended from the miniature riband, so the riband lies under the collar and the top of the badge is positioned 20mm below the highest secured button, as shown in Figure 6B-2.

21. Officers who have been awarded the insignia of the second class of an order, Knight Commander, are to wear the neck badge as well as the star.

Figure 6B-2: Wearing of Neck Badges, facing the wearer

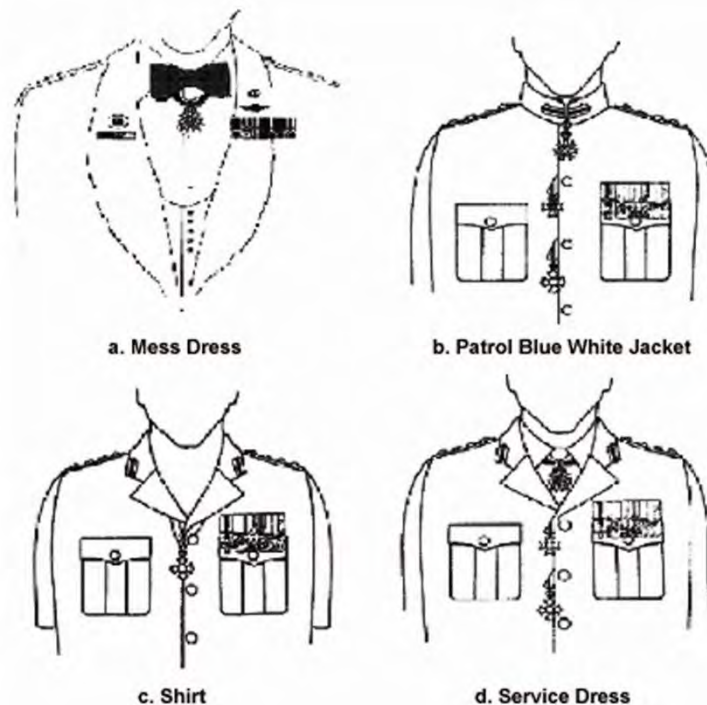

**WEARING STARS OF ORDERS AND NECK BADGES WITH MESS DRESS
ORDERS OF DRESS**

22. Stars of orders and neck badges are to be worn with Mess Dress as follows:
- a. in Army messes when a member of the Royal Family or a representative of the Sovereign is present
 - b. at those non-Service functions in [annex 5A](#) where the host has intimated that Service members should wear mess dress orders of dress
 - c. at Army balls
 - d. at Army dinners, when ordered.

WEARING THE INSIGNIA OF KNIGHTS BACHELOR

23. The insignia of Knights Bachelor is to be worn as follows:
- a. **Australian Army uniforms.** The badge from the miniature width riband, is to be worn around the neck in the manner, IAW [annex 6A](#). Alternatively, the Knights Bachelor badge is to be affixed to the left side of the jacket.
 - b. **Evening dress, either tail coat or dinner jacket.** The badge suspended from the miniature width riband, is worn around the neck, under the collar and hanging close up below the tie. Alternatively, the badge is to be worn as a Star of an Order on the left side of the jacket or coat. At the same time, provided that the holder of the badge is in possession of one or more other orders, decorations or medals, it is permissible to wear the miniature of the badge of a Knights Bachelor with miniatures.
 - c. **Morning Dress or lounge suit.** On suitable occasions, at the discretion of the holder, the badge suspended from the miniature width riband is worn around the neck under the collar. The badge is positioned 20mm below the tie knot in front of the tie. Alternatively, the badge is to be worn as a Star of an Order on the left side of the jacket or coat.

ORDER OF THE BRITISH EMPIRE, BRITISH EMPIRE MEDAL

24. Appointments to, or promotions in, the Order of the British Empire and awards of the British Empire Medal (BEM) are so described. A holder of the BEM, if subsequently appointed to the Order, continues to wear the ribbon of the medal and also wears the ribbon of the Order.

MEDAL RIBBONS

25. When ribbons are worn apart from the orders, decorations and medals, a ribbon is to be worn for each medal, except the Garter, Thistle and St Patrick. The ribbon is the same for all classes of an order.

ORDER OF WEARING AUSTRALIAN HONOURS AND AWARDS (MODIFIED)

FROM ORDER OF WEARING PUBLISHED IN THE DEFENCE HONOURS AND AWARDS MANUAL

1. The Governor-General notifies for general information the positioning of the wearing of Australian orders, decorations and medals.
2. A full list of the order of wearing for the Australian and Imperial systems of honours and awards is found at www.defence.gov.au/Medals/Policy/Order-Wearing.asp.
3. Imperial honours and awards issued under the Australian system **prior to 5 October 1992**, are considered Australian awards and their status will be upheld. Those awards are to be worn IAW the Defence Honours and Awards Manual and carry any appropriate post-nominals.
4. Imperial honours and awards approved for wear on or **after 5 October 1992**, are foreign awards and **are to be worn after all Australian awards**.
5. The following Schedule is an excerpt from the Defence Honours and Awards Manual that details the following awards:
 - a. those within the Australian system of honours and awards
 - b. those conferred by The Sovereign in exercise of the Royal Prerogative
 - c. those within the Order of St John
 - d. foreign awards, the acceptance and wearing of which have been authorised by the Governor-General.

Australian Honours and Awards Schedule (Modified)

| | | |
|---|----------|-------|
| Victoria Cross for Australia | | VC |
| Cross of Valour | CV | |
| Order of Merit | | OM |
| Knight/Dame of the Order Of Australia | Note (a) | AK/AD |
| Companion of the Order of Australia | | AC |
| Officer of the Order of Australia | | AO |
| Commander of the Royal Victorian Order | | CVO |
| Star of Gallantry | | SG |
| Star of Courage | SC | |
| Distinguished Service Cross | | DSC |
| Member of the Order of Australia | | AM |
| Lieutenant of the Royal Victorian Order | | LVO |
| Member of the Royal Victorian Order | | MVO |
| Conspicuous Service Cross | | CSC |

ADM

6C-2

| | | |
|--|----------|-----|
| Nursing Service Cross | | NSC |
| Medal for Gallantry | | MG |
| Bravery Medal | | BM |
| Distinguished Service Medal | | DSM |
| Public Service Medal | | PSM |
| Australian Police Medal | APM | |
| Australian Fire Service Medal | | FSM |
| Ambulance Service Medal | | ASM |
| Emergency Services Medal | | ESM |
| Medal of the Order of Australia | | OAM |
| Order of St John | Note (b) | |
| Conspicuous Service Medal | | CSM |
| Australian Antarctic Medal | Note (c) | AAM |
| Royal Victorian Medal | | RVM |
| Commendation for Gallantry | | |
| Commendation for Brave Conduct | | |
| Commendation for Distinguished Service | | |

War, Campaign, Active Service and Service Medals

| | |
|---|----------|
| Australian Active Service Medal 1945-75 | Note (d) |
| Vietnam Medal | |
| Vietnam Logistic and Support Medal | Note (e) |
| Australian Active Service Medal | Note (d) |
| International Force East Timor Medal | |
| Afghanistan Medal | |
| Iraq Medal | |
| Australian Service Medal 1945-75 | Note (d) |
| Australian General Service Medal for Korea | |
| Australian Service Medal | Note (d) |
| Australian Operational Service Medal | Note (f) |
| Australian Operational Service Medal (Civilian) | |
| Rhodesia Medal | |
| Police Overseas Service Medal | Note (d) |
| Humanitarian Overseas Service Medal | Note (d) |
| National Emergency Medal | |
| Civilian Service Medal 1939-1945 | |
| National Police Service Medal | |

Coronation, Jubilee, Remembrance and Commemorative Medals, (worn in order of date of receipt)

- Queen Elizabeth II Silver Jubilee Medal
- Queen Elizabeth II Golden Jubilee Medal
- Queen Elizabeth II Diamond Jubilee Medal
- 80th Anniversary Armistice Remembrance Medal
- Australian Sports Medal
- Centenary Medal

Australian Long Service Medals

Defence Force Service Medal
Reserve Force Decoration RFD
Reserve Force Medal
Defence Long Service Medal
National Medal
Australian Defence Medal
Australian Cadet Forces Service Medal
Champion Shots Medal
Anniversary of National Service 1951-1972 Medal
Foreign Awards (in order of date of authorisation of their acceptance and wearing)

Notes:

- (a) Provision for further awards at this level within the Order of Australia was removed by Her Majesty, Queen Elizabeth II on 03 March 1986 on the advice of the then Prime Minister. The award was officially re-introduced in 2014 and removed again in 2015.
- (b) Listed to indicate where any awards within the Order of St John should be worn; however, the Service Medal of the Order of St John should be worn as a Long Service Medal after all other Imperial Long Service awards. Post-nominals within the Order of St John are not recognised as notified in the Governor-General's media release of 14 August 1982. (The Life Saving Medal is worn on the right side).
- (c) The Australian Antarctic Medal was known as the Antarctic Medal until 18 December 1997.
- (d) Clasps to these medals are worn on the ribbon in order of date of receipt.
- (e) A person who has been awarded the Vietnam Medal, or who is eligible for the award of the Vietnam Medal, is not eligible for the award of the Vietnam Logistic and Support Medal.
- (f) Worn in order of date of qualifying service.

General Note:

The Unit Citation for Gallantry, the Meritorious Unit Citation and the Group Bravery Citation are to be worn by members of the Australian Defence Force IAW the dress rules of their respective Services.

FOREIGN AWARDS

GENERAL

1. Foreign awards are those made by a foreign government or organisations such as the UN, NATO and MFO. Foreign orders, decorations and medals are not to be accepted or worn unless the permission of the Sovereign has first been obtained, in which documentary evidence is required. Permission, if granted, will be qualified as either 'UNRESTRICTED' or 'RESTRICTED'. Permission to accept and wear foreign awards is to be sought by contacting www.defence.gov.au/Medals/Content/AwardsOnlineForm.asp.

2. Current guidelines for the acceptance and wearing of foreign awards, require a formal approach by the foreign government to the Australian Government.

RESTRICTED OR UNRESTRICTED APPROVAL

3. Unrestricted permission allows the recipient to wear foreign insignia on all occasions when orders, decorations and medals are worn.

4. Under the grant of restricted permission by the Sovereign for the acceptance or wearing of a foreign order, the conditions of wearing the order, decoration or medal or its miniature will be as specified. Permission usually includes wearing on some or all of the following occasions:

- a. in the presence of the Sovereign or Head of State of the country to which the order, decoration or medal belongs
- b. in the presence of any member of the Royal Family of the country concerned
- c. at the residence of any ambassador, minister or consular officer of that country in Australia
- d. when attached to, or when officially meeting any officer of the armed services or official deputation of that country
- e. at an Army official or semi-official ceremony held exclusively in connection with that country, such as a memorial service, unveiling of a monument or opening an institution; and on all official occasions while in that country.

WEARING OF FOREIGN AWARDS

5. When a foreign award is worn on the occasions mentioned in paragraph 4 to this annex, it should be given precedence over any Australian order or decoration usually worn. Otherwise, all foreign awards are to be worn after all Australian awards, in the order of date of approval to wear.

6. Stars of foreign orders are to be worn on the right or left breast, according to the regulations laid down by the Sovereign or Head of State by whom they are conferred.

7. Foreign medals, other than war medals, are governed, by the same rules as foreign decorations. A foreign war medal, its ribbon or miniature and the wearing of which has been approved by the Sovereign, is to be worn with all orders of dress in the same way as Australian medals but placed after all Australian awards. When worn with other foreign medals, it is worn in the order of date of approval to wear.

8. Ribbons of foreign orders, decorations and medals, when worn without their insignia, are to be the plain ribbons of the orders, decorations or medals. If the foreign order includes an emblem or a rosette on the ribbon of the badge of the insignia, the emblem will also be worn on the ribbon in the manner customary in the country concerned. The ribbon of a foreign order, decoration or medal will be the grade or class which most closely conforms in width to that of a British medal ribbon, provided that a ribbon of a higher grade or class to that awarded is not worn.

9. Where more than one foreign honour or award from the same nation has been awarded to a member, they are to be worn in accordance with the order of wear of that nation. For example, if a member was awarded and approved to wear the United States Meritorious Service Medal in 2012 and is later awarded and approved to wear the United States Bronze Star in 2014, the United States Bronze Star is to be worn before the United States Meritorious Service Medal.

WEARING OF FOREIGN AWARDS EARNED WHILE A MEMBER OF A FOREIGN SERVICE

10. Approval may be given for a person enlisting in the Australian Army to wear medals earned while a member of a Foreign Service. The basic criteria for approval and wearing are as follows:

- a. such medals were earned during operations which are supported by the Australian Government
- b. were not earned while serving with enemy forces
- c. awards have equivalent Australian awards, for example, long service awards should have similar qualifying periods.

AWARD SPECIFICATIONS, REGULATIONS AND ASSEMBLY INSTRUCTIONS

GENERAL

1. Orders, decorations and medals are to be kept clean and in good repair. Ribbon worn with insignia or as a ribbon bar is to be clean, not frayed and in good condition. Protective covering **is not** to be used to cover ribbon bars and attached emblems are to be securely fastened.

SECURITY

2. A member is to ensure that all orders, decorations and medals received by them are secure when not in use. Care is to be taken to prevent awards falling into the possession of unauthorised persons.
3. Awards sent via post are to be sent as mail that requires a signature on delivery.
4. A member who illegally disposes of an order, decoration or medal is liable to prosecution.

REPLACEMENT OF MEDALS

5. Replacement medals may be applied for at www.defence.gov.au/Medals/Policy/Order-Wearing.asp.

MEDAL MOUNTING

6. Full size and miniature medals **are to be court mounted**, either as a single medal or multiple medal group in accordance with (IAW) paragraphs 10–20 to this annex.
7. A rigid base is to be used to support court mounted medals to ensure an appropriate standard of presentation is maintained. A polyurethane base, measuring 2mm in depth, is recommended for this purpose to achieve long term sustainability.
8. Medals are to be sewn securely to the base, IAW paragraphs 10–20 of this annex, ensuring a rigid setting is achieved.
9. Glue or other adhesive products **are not** to be applied to secure medals to the base.

FULL SIZE MEDALS

10. Full size medals are to be court mounted and positioned centrally on the Australian Army uniform with the top edge of the riband 16mm above the top edge of the left breast pocket.

11. They are to be court mounted to a length of 95mm (top to bottom), affixed to a rigid base behind the medals measuring 75mm in length (top to bottom). This regulation applies to the mounting of a single medal or medals forming a multiple medal group.

12. When two or more medals are court mounted the top edge of the riband is to run parallel with the lower edge of the medals maintaining the 95mm length across the entire medal group. The medal group is not to extend inward beyond the button line of the coat, jacket or shirt or protrude beyond the outer edge of the garment sleeve.

13. Up to **five** full size medals are to be court mounted side by side with no ribbon overlap as shown in Figure 6E-1.

14. **Six to nine** full size medals are to be court mounted on a graduating scale of width, with ribbon overlap as shown in Figure 6E-2.

15. Medal groups are not to exceed the following widths:

- a. six medals – 165mm
- b. seven medals – 170mm
- c. eight medals – 180mm
- d. nine medals – 190mm

16. Medal groups comprising **ten to thirteen** full size medals are to be court mounted with ribbon overlap, as shown in Figure 6E-3, and **are not to** exceed 200mm in width.

Figure 6E-1: Five full size medals are court mounted side by side



Figure 6E-2: Six to nine full size medals are court mounted with ribbon overlap



Figure 6E-3: Ten to fourteen full size medals are court mounted with ribbon overlap



17. Medal groups comprising **fourteen or more** full size medals are to be court mounted with ribbon overlap and **are not to** exceed 240mm in width.

MINIATURE MEDALS

18. Miniature medals are to be court mounted side by side with no ribbon overlap, to a length of 50mm (top to bottom), affixed to a rigid base behind the medals measuring 40mm in length (top to bottom). This regulation applies to the mounting of a single miniature medal or miniature medals forming a multiple medal group.

19. When two or more miniature medals are court mounted the top edge of the ribbon is to run parallel with the lower edge of the medals maintaining the 50mm length across the entire medal group as shown in Figure 6E-4.

20. Miniature medal groups are worn with mess dress orders of dress IAW [annex 5O](#) and are not to extend beyond the inner edge of the left lapel or protrude beyond the outer edge of the garment sleeve.

21. Ribbon overlap is authorised if the width of the miniature medal group does not comply with the above regulation.

Figure 6E-4: Miniature medals court mounted side by side



COMMENDATION FOR GALLANTRY, BRAVE CONDUCT AND DISTINGUISHED SERVICE

22. The Commendation for Gallantry, Brave Conduct and Distinguished Service are to be court mounted as for full size medals and worn as orange, blood-red and ochre coloured ribands respectively, measuring 95mm in length (top to bottom) as shown in Figure 6E-5.

23. The Commendation for Gallantry/Commendation for Distinguished Service insignia, a gold plated/nickel-silver plated Federation Star superimposed on a row of flames, is positioned centrally and horizontally on the riband with the centre of the insignia 19mm from the bottom edge of the riband.

24. The Commendation for Brave Conduct insignia, a gold-gilt sprig of mimosa, is positioned centrally on the riband with the centre of the insignia 19mm from the bottom edge of the riband. The insignia is to be placed at an angle of 45° with the top of the sprig pointing toward the left shoulder.

25. Miniature commendations are to be court mounted as for miniature medals to a length of 50mm (top to bottom).

26. Miniature commendation insignia are to be positioned on the miniature riband in the same manner as for full size insignia using half the distance.

27. Subsequent awards of the above commendations are denoted by the positioning of additional insignia on the riband as follows and as shown in Figure 6E-6:

- a. Commendation for Gallantry/Commendation for Distinguished Service – insignia for a subsequent award is positioned 3mm above the previous insignia.
- b. Commendation for Brave Conduct – insignia for a subsequent award is positioned on an angle of 45° and 25mm above the previous insignia.

28. Additional miniature commendation insignia for subsequent awards are positioned on the miniature riband in the same manner as for full size insignia using half the distance.

Figure 6E-5: Commendation insignia placement on ribands



Figure 6E-6: Commendation insignia placement on ribands of subsequent awards

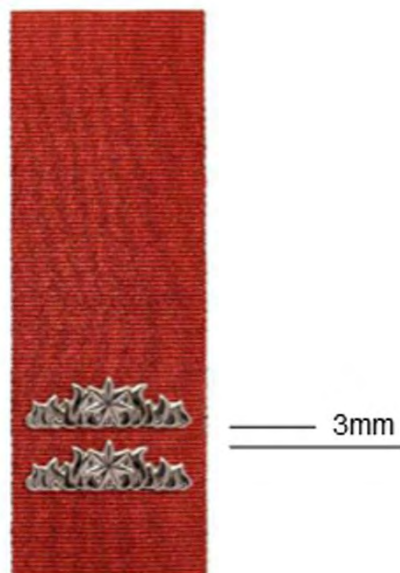

BARS AND CLASPS TO DECORATIONS AND MEDALS

Bars

29. Bars are awarded to denote a second and subsequent award of decorations and medals for gallantry, bravery, distinguished service and conspicuous service.

ADM

6E-6

30. Bars are not to be confused with clasps to Service medals that denote areas of operation or additional periods of long service.

31. Bars are positioned horizontally and centrally on the riband, with second and subsequent bars spaced equidistant as shown in Figure 6E-7.

32. Examples of terminology used to identify an additional award to the same recipient are as follows:

- a. Conspicuous Service Cross and Bar
- b. CSC and Bar

33. Miniature bars are positioned as for bars IAW paragraph 31.

Figure 6E-7: Positioning of bars



Clasps

34. Clasps defining areas of operation or specific events are positioned on the following medals:

- a. Australian Active Service Medal 1945-75
- b. Australian Active Service Medal
- c. Australian Service Medal 1945-75
- d. Australian Service Medal
- e. Humanitarian Overseas Service Medal
- f. National Emergency Medal.

35. Clasps denoting additional periods of qualifying service for Defence long service awards are positioned on the following medals:

- a. Defence Force Service Medal
- b. Reserve Force Decoration (gilt clasps)

ADM

6E-7

- c. Reserve Force Medal
- d. Defence Long Service Medal
- e. Australian Cadet Forces Service Medal.

36. Clasps displaying the year of award are positioned on the Champion Shots Medal.

37. Clasps for the Service medals listed above are positioned horizontally on the riband with the lowest edge of the first clasp 3mm above the bottom edge of the riband. Subsequent clasps are worn in order of receipt with 1mm between clasps as shown in Figure 6E-8.

38. There is no set number of clasps that may be positioned on either the full size or miniature AASM or ASM. If the standard length of riband does not allow for the positioning of an additional clasp, ribands of all medals within the medal group are to be extended (for consistency) in order to accommodate the additional clasp. Full size and miniature clasps on extended length ribands are to be positioned, IAW paragraph 37 of this annex.

39. Miniature clasps are positioned on the miniature riband in the same manner as for full size clasps using half the distance.

Figure 6E-8: Positioning of clasps on Service medals



Australian Operational Service Medal accumulated service device

40. An antique silver accumulated service device in the form of numerals is awarded for a second or subsequent deployment to operations on completion of the prescribed qualifying period.

41. The device is positioned centrally on the riband of the full size and miniature medal as shown in Figure 6E-9. The same sized device is used for full size and miniature medals.

Figure 6E-9: Accumulated service device



Ribbon bars

42. Ribbon bars measuring 11-13mm in length (top to bottom) are to be positioned centrally with the lower edge of the ribbon bar 3mm above the top edge of the left breast pocket.
43. Ribbon bars are to comprise of no more than three awards for females or four awards for males in a single row as shown in Figure 6E-10.
44. Second and subsequent rows are to be positioned 3mm above the preceding row and are not to extend beyond the width of the lower row. This may occur when a ribbon exceeds 32mm in width, for example ribbons of the Member of the Order of Australia and NATO Non Article 5 awards measuring 38mm in width.
45. To ensure compliance of the above regulation the senior award in the order of wearing is moved up into the next row irrespective of the number of awards displayed on the lower row as shown in Figure 6E-11. In this example the third row is left with three ribbons moving the wider ribbon of the Member of the Order of Australia up into the fourth row.

Figure 6E-10: Assembly and positioning of female and male ribbon bars

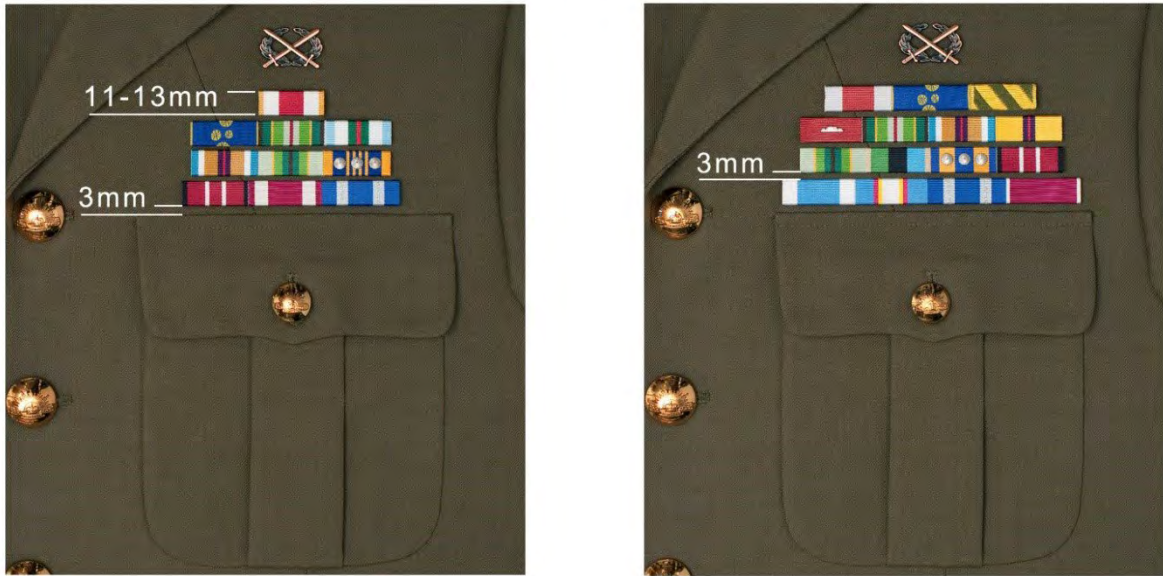
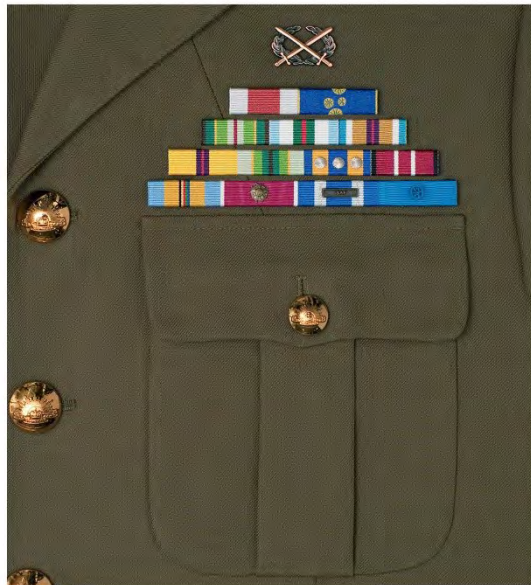

Figure 6E-11: Fourth row added to comply with width regulation of lower rows



Ribbon bar emblems, insignia and accumulated service devices

46. A ribbon bar emblem is worn centrally on a recipient's ribbon bar for the first award of the following decorations and medal as shown in Figure 6E-12:

- a. Victoria Cross VC
- b. Cross of Valour CV (may be awarded to civilian and military personnel)
- c. Star of Courage SC (may be awarded to civilian and military personnel)
- d. Bravery Medal BM (may be awarded to civilian and military personnel)

47. A ribbon bar emblem denoting a second and subsequent award of decorations and medals for gallantry, bravery, distinguished service and conspicuous service are positioned equidistant from each other and the extremities of the ribbon as shown in Figure 6E-13.

48. Miniature commendation insignia are positioned centrally and horizontally on ribbon bars for the following as shown in Figure 6E-14:

- a. Commendation for Gallantry
- b. Commendation for Brave Conduct
- c. Commendation for Distinguished Service

49. Additional miniature commendation insignia for subsequent awards are positioned on the ribbon bar as shown in Figure 6E-15.

50. An antique silver accumulated service device in the form of numerals is worn centrally on the ribbon bar of the Australian Operational Service Medal as shown in Figure 6E-16.

Figure 6E-12: Positioning of ribbon bar emblems



Figure 6E-13: Positioning of second and subsequent ribbon bar emblems



Figure 6E-14: Positioning of commendation insignia on ribbon bars



Figure 6E-15: Positioning of commendation insignia on ribbon bars for subsequent awards



Figure 6E-16: Positioning of accumulated service device



Rosettes

51. A rosette is positioned on the ribbon of Defence long service awards in lieu of clasps to denote additional periods of qualifying service on ribbon bars when wearing general duty orders of dress.

52. Circular cupro-nickel rosettes, representative of the award, are positioned on the ribbon of the Defence Force Service Medal and the Defence Long Service Medal. Oval rosettes are positioned on the Reserve Force Decoration and the Reserve Force Medal.

53. The first rosette is positioned centrally with additional rosettes positioned equidistant across the ribbon bar. This regulation applies to all Defence long service awards as shown in Figure 6E-17.

Figure 6E-17: Positioning of rosettes



Federation Star

54. A Federation Star is positioned centrally on the ribbon of Defence long service awards in lieu of the Fifth Clasp to denote forty years service when wearing general duty orders of dress as shown in Figure 6E-18.

55. Additional Federation Stars are positioned equidistant across the ribbon bar for further periods of qualifying service as shown in Figure 6E-18. This regulation applies to all Defence long service awards.

Figure 6E-18: Positioning of the Federation Star



ORDER OF AUSTRALIA AWARDS

Ribbon

56. Due to the pattern irregularity of the ribbon of the Order of Australia, the area confined within the dotted lines in Figure 6E-19 defines the direction the ribbon is to face when awards within the Order are court mounted.

ADM

6E-12

57. Two ribbon widths are used to court mount awards within the Order of Australia:

- a. 38mm ribbon – Member of the Order of Australia
- b. 32mm ribbon – Medal of the Order of Australia

58. The 16mm miniature ribbon is used to suspend the insignia of the Companion and Officer of the Order of Australia from the recipient's neck.

Ribbon bars

59. The same portion of ribbon outlined in paragraph 56, is to be used in the production of ribbon bars.

60. A 38mm portion of ribbon is used for the following awards:

- a. Companion of the Order of Australia (AC)
- b. Officer of the Order of Australia (AO)
- c. Member of the Order of Australia (AM).

61. A 32mm portion of ribbon is used for the award of the Medal of the Order of Australia (OAM).

Figure 6E-19: Order of Australia ribbon direction and ribbon bar portion



CLASPS, NUMERALS AND MULTI-TOUR INDICATORS FOR NATO, MFO AND UN AWARDS

NATO Medal clasps

62. Clasps defining areas of operation are positioned on full size and miniature NATO Medals IAW Figure 6E-20.

NATO multi-tour indicators on medals

63. A multi-tour indicator (MTI) for additional qualifying deployments as part of NATO led operations is positioned centrally on the medal riband 1mm above the clasp for full size medals and half that distance for miniature medals.

NATO Ribbon bars

64. A miniature ISAF Clasp is positioned centrally on the NATO Non-Article 5 ribbon bar for deployments that occurred from 1 January 2011 as shown in Figure 6E-20. No clasp is positioned on the ribbon bar for qualifying service prior to this date.

65. A miniature Afghanistan Clasp is positioned centrally on the NATO Non-Article 5 ribbon for deployments that occurred from 1 January 2015.

66. MTIs are centrally positioned on the far right blue stripe of the NATO ribbon bar as shown in Figure 6E-20.

Figure 6E-20: NATO medal clasps and multi-tour indicator



MFO and UN numerals for additional qualifying deployments

67. Nickel-silver plated numerals for additional qualifying deployments as part of MFO and UN led operations are positioned centrally on the medal riband of full size medals, miniature medals and ribbon bars as shown in Figure 6E-21.

68. Standard bronze numerals originally designed for additional qualifying deployments for the MFO Medal, as shown in Figure 6E-22, are authorised for wear if available to the recipient.

Figure 6E-21: MFO and UN numerals



Figure 6E-22: Standard MFO bronze numeral



ADM

UNCLASSIFIED

AL5

UNCLASSIFIED